A large construction crane is shown in the upper half of the image, lifting a prefabricated building module. The module is a rectangular box with a flat roof and a small balcony area, suspended by cables. Below the crane, a modern multi-story building is under construction, featuring a mix of dark grey and light grey panels, large windows, and balconies. The background is a clear blue sky with some light clouds. In the bottom right corner, a parking lot with several cars and some greenery is visible.

Design for Manufacturing and Assembly (DfMA)

Prefabricated Prefinished
Volumetric Construction

Contents

Chapter 1

Introduction

6

Chapter 2

PPVC Considerations and Key Factors

10

- 2.1 Early Involvement of Contractors
- 2.2 Types of PPVC Modules
- 2.3 Transportation
- 2.4 Configuration of PPVC Modules
- 2.5 Type of Hoisting Machinery
- 2.6 Comparison of Reinforced Concrete (RC) Module and Steel Module

Chapter 3

Design Considerations

18

- 3.1 Architectural Design Considerations
 - 3.1.1 Modularisation
 - 3.1.2 Early Coordination
 - 3.1.3 Dimension on Plan
 - 3.1.4 Dimension on Section
 - 3.1.5 Vertical and Horizontal Alignment
 - 3.1.6 Water-Tightness Between Modules
 - 3.1.7 Consideration of Construction Tolerance
- 3.2 Structural Design Considerations
 - 3.2.1 Structural Modelling
 - 3.2.2 Vertical Modules Connection
 - 3.2.3 Horizontal Modules Connection
 - 3.2.4 Structural Robustness
 - 3.2.5 Modules Connection to Civil Defense Shelter Wall
 - 3.2.6 Structural Design of Modules
 - 3.2.7 Periodic Structural Inspection (PSI)
- 3.3 Mechanical, Electrical and Plumbing (MEP) Design Considerations
 - 3.3.1 Electrical
 - 3.3.2 Lightning Protection
 - 3.3.3 Water
 - 3.3.4 Sanitary
 - 3.3.5 Air-Conditioning & Mechanical Ventilation
 - 3.3.6 Town Gas
- 3.4 Compliance with Fire Safety Requirements
 - 3.4.1 Compliance of Fire Compartmentation
 - 3.4.2 Compliance of Use of Material

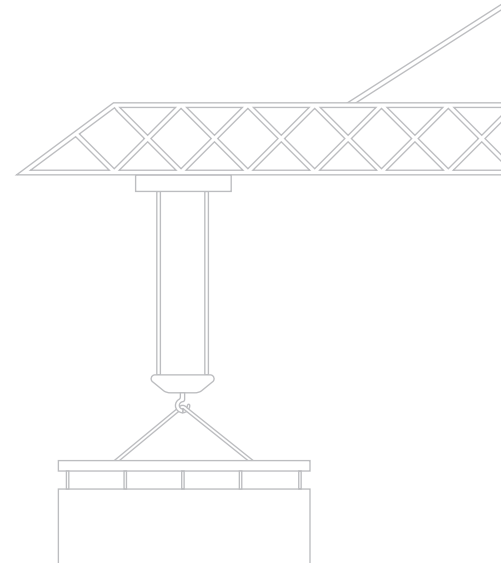

Chapter 4

PPVC Module Production

38

- 4.1 Reinforced Concrete (RC) PPVC Production
 - 4.1.1 Mould Process
 - 4.1.2 Structural and MEP Works
 - 4.1.3 Architectural Finishing and MEP Works
- 4.2 Steel PPVC Production
 - 4.2.1 2D And 3D JIG
 - 4.2.2 Fabrication Process

Chapter 5

Protection, Transportation and Lifting

56

- 5.1 Transportation Plan
- 5.2 Packaging, Protection and Labelling
- 5.3 Module Cover (Temporary or Permanent)

Chapter 6

Construction and Project Management

58

- 6.1 Location of the Project and Adjacent Areas
- 6.2 Access and Traffic Management for Trailers with Heavy Cargo
- 6.3 Consideration of Just-In-Time (JIT) Operation
- 6.4 Types of Cranes
- 6.5 Safety

Chapter 7

Installation

62

- 7.1 Access and Egress
- 7.2 Vertical and Horizontal Alignments
- 7.3 Sequencing of the Modules Installation
- 7.4 Safety

Chapter 8

Critical Inspections and Quality Checks

64

- 8.1 Quality Checks
 - 8.1.1 Reinforced Concrete PPVC
 - 8.1.2 Steel PPVC
- 8.2 Structural Works
- 8.3 MEP Works
- 8.4 Architectural Works

Chapter 9

Maintenance, Replacement and Renovation

72

- 9.1 Renovation
 - 9.1.1 Homeowner User Manual

Chapter 10

Regulations

74

- 10.1 List of Regulators
- 10.2 Minimum Level of Off-Site Work for PPVC
- 10.3 Building Innovation Panel (BIP) and PPVC Manufacturer Accreditation Scheme (MAS)
- 10.4 Code of Practice and Good Industry Practice Guidebooks (References)
- 10.5 Design for Safety
 - 10.5.1 Access/Egress
 - 10.5.2 Choice Between Fall Prevention, Fall Restraint and Fall Arrest System
 - 10.5.3 Module Installation and Alignment
 - 10.5.4 Useful Resources

Appendix

Some PPVC Projects References in Singapore (completed and ongoing)

This guide may be used for reference purposes only. The contents of this guide are protected by copyright and other forms of proprietary rights owned by, licensed to or controlled by BCA and shall not be reproduced, republished, uploaded, posted, transmitted or otherwise distributed in any way, without the prior written permission of BCA. Modification of any of the contents or use of the contents for any other purpose will be a violation of BCA's copyright and other intellectual property rights. Any reference herein to any specific commercial products, process, or service by trade name, trademark, manufacturer, or otherwise, does not constitute or imply BCA's endorsement or recommendation.

"All content used herein is for non-profit educational purposes. Where possible, all credit has been given to the respective owners or creators of the content."

Foreword

Under the Construction Industry Transformation Map, we are transforming Singapore's built environment sector into one that is technologically advanced and highly productive. BCA has identified the Design for Manufacturing and Assembly (DfMA) approach as a key strategic thrust to raise the construction productivity. This Prefabricated Prefinished Volumetric Construction (PPVC) guidebook is the first installment of a series of guidebooks on DfMA technologies. This guidebook will share on key aspects of PPVC and associated good practices, hence allowing practitioners to appreciate and reap the full benefits of off-site manufacturing. Besides the possibility for earlier project completion, end users can enjoy high quality works given that most of the works are carried out in a controlled factory environment.

This guide provides simple and practical tips to practitioners on how PPVC is designed, fabricated, inspected, delivered and installed to achieve its functional requirements and workmanship standards. Good practices such as upfront planning and design to incorporate PPVC adoption will also be covered. When constructed, such PPVC buildings would be no different from conventional buildings and can have creative design and interesting facades.

As this is an evolving technology, this guide is not meant to be a definitive publication on how PPVCs must be designed and installed. Practitioners are encouraged to use this guide to innovate and improve further on PPVC design, fabrication and installation. To obtain more comprehensive information and guidance, readers should seek professional advice from designers and suppliers of PPVCs. We gratefully acknowledge the contributions of key technical agencies and practitioners in the production of this guide and trust that the industry will find this publication useful. We welcome any contributions from readers to improve subsequent editions of this guide.

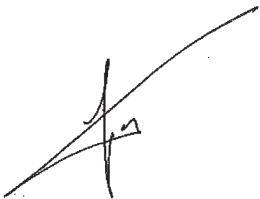

NEO CHOON KEONG

Deputy Chief Executive Officer
Industry Development
Building and Construction Authority

Acknowledgement

This Prefabricated Prefinished Volumetric Construction (PPVC) Guidebook was developed by the Working Committee in close collaboration with key technical agencies and industry representatives comprising Architects, Builders, Consultants, and Specialist Contractors.

A Technical Committee, comprising members from various industry associations and organisations, was formed to review the contents.

We wish to thank all members of the technical agencies as well as the Technical and Working Committee for their valuable contributions.

TECHNICAL COMMITTEE:

| | |
|--------------------------|---|
| Mr Ramamoorthy Rajendran | Building and Construction Authority (Chair) |
| Er Siew Hoong Kit | Nanyang Technological University (Co-Chair) |
| Ms Tay Seok Cheng | REDAS (Co-Chair) |
| Er Chee Kheng Chye | Housing and Development Board |
| Er Chan Ewe Jin | Institute of Engineers |
| Mr Kenneth Loo | SCAL |
| Ar Richard Lai | Singapore Institute of Architects |
| Ar Yeo Eng Choon | Singapore Institute of Architects |
| Mr Tan Chin Hock | ACES |
| Mr Wong Soon Tuan | Dragages Singapore Pte Ltd |
| Mr Eddie Kua | Tiong Seng Contractors Pte Ltd |
| Mr John Mo | Moderna Homes Pte Ltd |

WORKING COMMITTEE:

| | |
|------------------------|--|
| Ms Mika Feng | Building and Construction Authority (Lead) |
| Mr Lee Choon Shung | ADDP Architects LLP (Co-lead) |
| Er Liew Ve Koon | P&T Consultants Pte Ltd |
| Mr Johnny Lim | Teambuild Engineering & Construction Pte Ltd |
| Mr M.Bhuvanavarman | Integrated Precast Solutions Pte Ltd |
| Mr Lee Chong Whey | Moderna Homes Pte Ltd |
| Mr Sean Tan Huei Chong | Vico Construction Pte Ltd |
| Ms Toh Xing Juan | Building and Construction Authority |
| Mr Louis Chong | Building and Construction Authority |
| Mr Jonathan Kok | Building and Construction Authority |
| Mr Neo Seng Hai | Building and Construction Authority |
| Mr Han Wann Kuang | Building and Construction Authority |

TECHNICAL AGENCIES:

| | |
|-------------------------------|-------------------------------|
| Ministry of Manpower | Jurong Town Corporation |
| Singapore Civil Defence Force | Urban Redevelopment Authority |
| Public Utilities Board | Housing and Development Board |
| National Environmental Agency | Land Transport Authority |



ANG LIAN AIK

Group Director
Construction Productivity and Quality Group

Introduction

To raise construction productivity and fundamentally change the design and construction processes, the industry is encouraged to embrace the concept of Design for Manufacturing and Assembly (DfMA), where construction is designed and detailed for a substantial portion of work to be done off-site in a controlled manufacturing environment.

DfMA is a new approach in the construction industry. By planning more works offsite, manpower and time needed to construct buildings are reduced, while ensuring work sites are safe, conducive and have minimal impact on the surrounding living environment. The use of prefabrication methods in construction has been promoted as a way to improve productivity in a traditionally manpower-intensive industry.

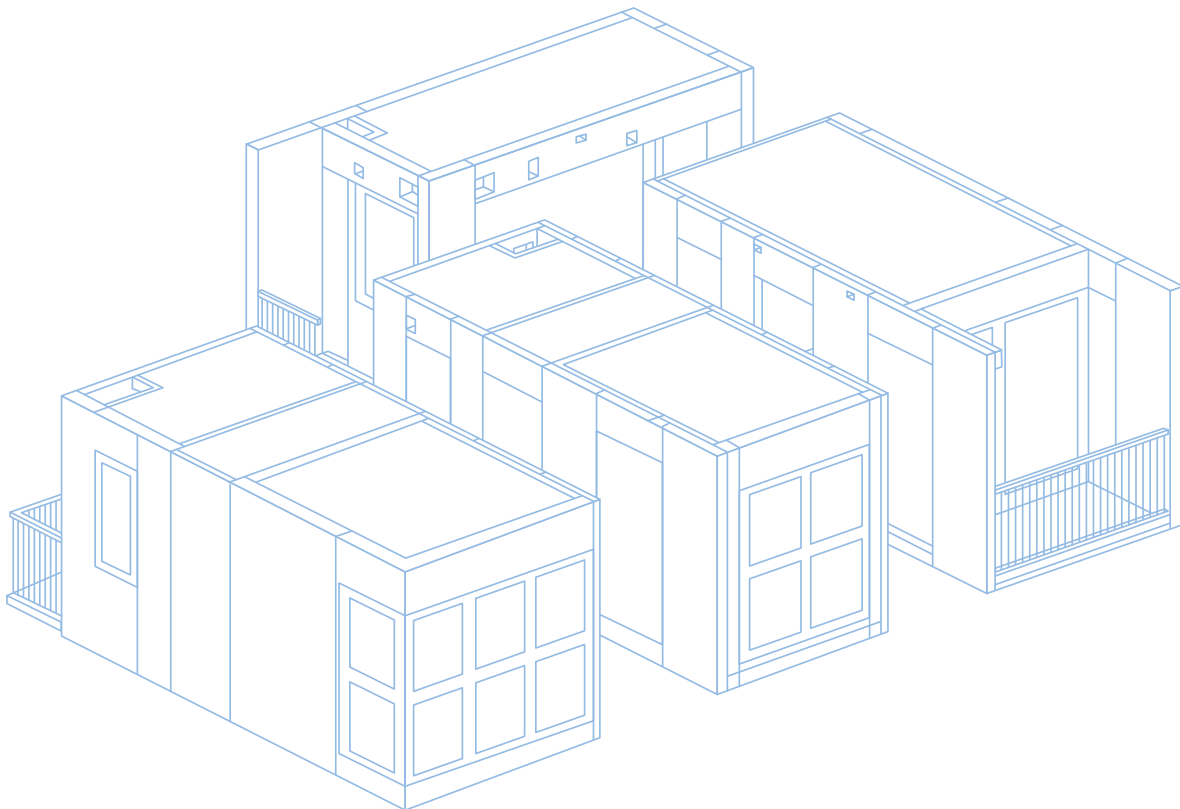

Prefabricated Prefinished Volumetric Construction (PPVC) is one of the game-changing technologies that support the DfMA concept to significantly speed up construction. Modular is a general construction term to describe the use of technology that facilitates off-site manufacturing. Complete modules made of multiple units complete with internal finishes, fixtures and fittings are manufactured in factories, and are then transported to site for installation in a Lego-like manner. In the hierarchy of DfMA methodologies, PPVC is one of the most efficient and complete principles in improving productivity.

In this book, the DfMA methodology on PPVC and the benefits reaped will be discussed so that there is better knowledge and capability in the adoption and implementation of PPVC.

Pushing for Higher-end DfMA Technologies

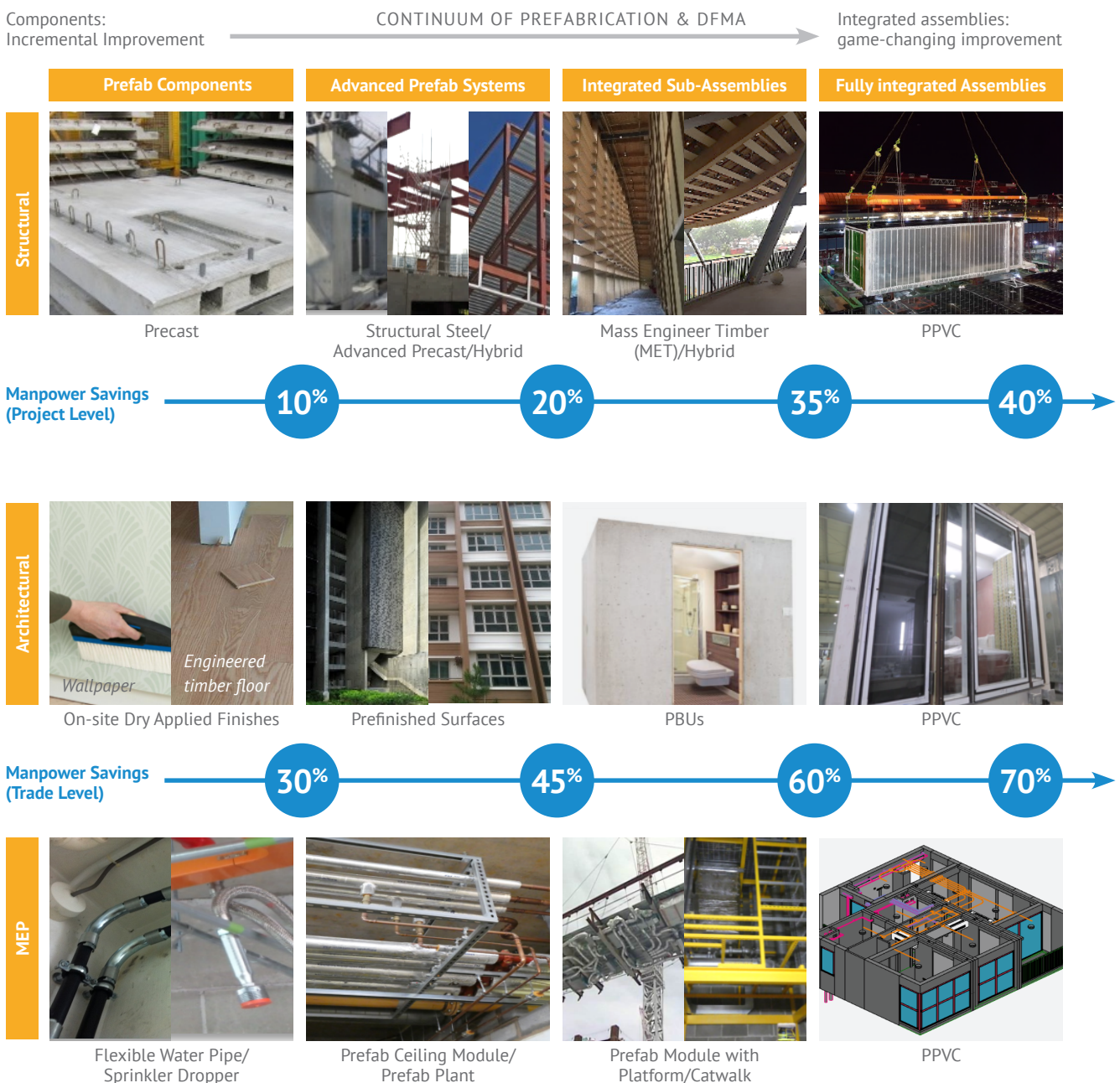

Comparison

CONVENTIONAL CONSTRUCTION



In a traditional manpower-intensive industry, most of the trade works involving structural, architectural, MEP and interior finishing works are constructed and installed on site.

PREFABRICATED PREFINISHED VOLUMETRIC CONSTRUCTION (PPVC)



“Prefabricated Prefinished Volumetric Construction (PPVC)” means a construction method whereby free-standing volumetric modules (complete with finishes for walls, floors and ceilings) are:

- a. constructed and assembled; or
- b. manufactured and assembled,

in an accredited fabrication facility, in accordance with any accredited fabrication method, and then installed in a building under building works.

Benefits of PPVC

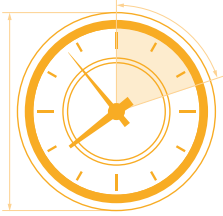

PRODUCTIVITY IMPROVEMENT

- Fabrication of PPVC can proceed in parallel in the factory while other worksite activities are ongoing to streamline the construction process.
- The on-site construction activities can be significantly reduced through the use of PPVC.
- It can potentially achieve a productivity improvement of more than 40% in terms of manpower on site and more than 20% time savings, depending on the complexity of the projects.

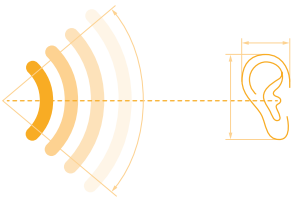

BETTER CONSTRUCTION ENVIRONMENT

- As more activities are done off-site, a reduction of environment pollution can be ensured as dust and noise pollution are potentially minimised.
- Disamenities to the surrounding neighbourhoods during construction can be diminished.
- Prefabrication of the building modules also leads to cleaner worksites by generating less overall construction waste on-site.



REDUCTION OF ON-SITE MANPOWER

- This will enhance worksite safety and direct the manpower to better working conditions. More construction off-site leads to less time on-site and fewer individual man-hours working at height.
- By reducing construction and installation activities and manpower from the site, and placing them off-site in a controlled factory environment, fewer workers will be on site which in turn leads to fewer accidents and less downtime.



BETTER QUALITY CONTROL

- PPVC delivers the majority of the final product from the controlled factory environment leading to increased reliability with higher-quality finishing.
- Sequence of work can be planned more efficiently with better logistics coordination.

PPVC can be considered for multi-room accommodations such as:

- Residences
- Institutions
- Hotels and hostels
- Nursing homes
- Dormitories

PPVC Considerations and Key Factors

2.1 Early Involvement of Contractors

- Given that each PPVC Fabricator has their own proprietary system for the manufacture of PPVC modules, it is highly encouraged to engage the PPVC Fabricator as well as the Main Contractor early upfront during the design stage to allow their inputs into the design for a better and more effective technical solution.
- The Design and Build (D&B) and Design Development and Build (DDB) procurement models can be adopted for PPVC projects as they allow greater inputs into the design upfront by the Main Contractor and their PPVC Fabricators. This will vastly increase the buildability and constructability of the PPVC design, leading to greater productivity in construction.

2.2 Types of PPVC Modules

The choice of material will dictate the size and number of modules in the design as weight is a major consideration for the hoisting of the modules.

Other major factors will involve logistics of transportation, site layout and holding area, crane or hoisting position.

| | Material | |
|--------------------------|----------|-------|
| | 1 | 2 |
| Characteristic of module | Concrete | Steel |
| Weight | Heavy | Light |

Limit by crane reach and capacity due to weight

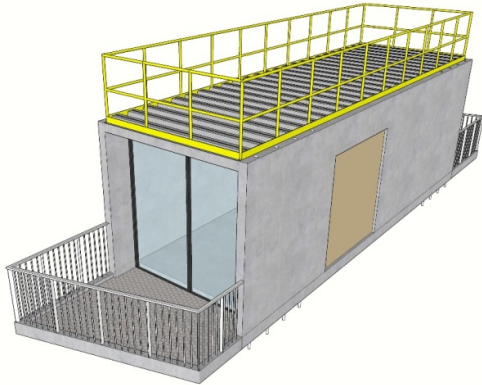

1

REINFORCED CONCRETE PPVC MODULE

Wall: Concrete
Floor: Concrete

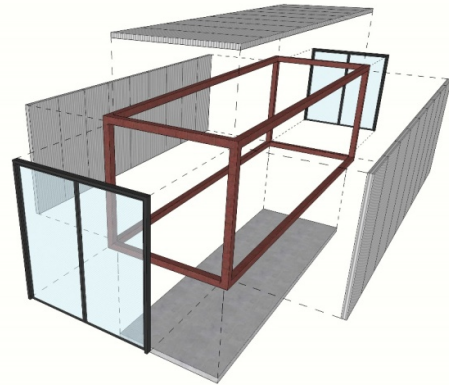

2

STEEL PPVC MODULE

Wall: Steel frame with lightweight walls
Floor: Concrete or Lightweight Flooring System

2.3 Transportation

Logistics for modules transportation from factory to site will determine the maximum size and volume of each module design, which in turn affects the number of modules to complete the layout design.

The size of a single module should be limited to the dimensions allowed to be transported on public road without requiring special measures such as police escort. Height consideration has to be factored in if the route involves passing through overhead bridges.

In compliance to LTA's traffic regulatory requirements, Police Escort will not be required, when the parameters are controlled.

| | |
|---------------------|--|
| Height | < 4.5 metres (inclusive of truck height) |
| Width | ≤ 3.4 metres |
| Laden Weight | < 80 tons |

Existing road configuration around the site has to be analyzed for the maneuvering and holding of the modules. The deliveries have to be planned and coordinated to avoid congestion outside the site especially for urban built-up areas.



*Figure: Transportation truck.
(Note: Dimensions are for reference only.)*

2.4 Configuration of PPVC Modules

The modules are configured according to the design layout. The geometry of the modules can be simplified to design for ease of production.

The number of modules will vary, depending on the residential unit typology (Studio, 1 to 5 rooms). Total number of modules can typically range from 1 to 8 numbers per unit.

Demarcation of a typical unit module with reference to plan below is as follows:

- **Module A:** LRDIN (Living and Dining Room)
- **Module B:** B2-IBB (Bedroom 2 with In-built Bathroom)
- **Module C:** MB-IBB (Master Bedroom with In-built Bathroom)
- **Module D:** KIT (Kitchen)

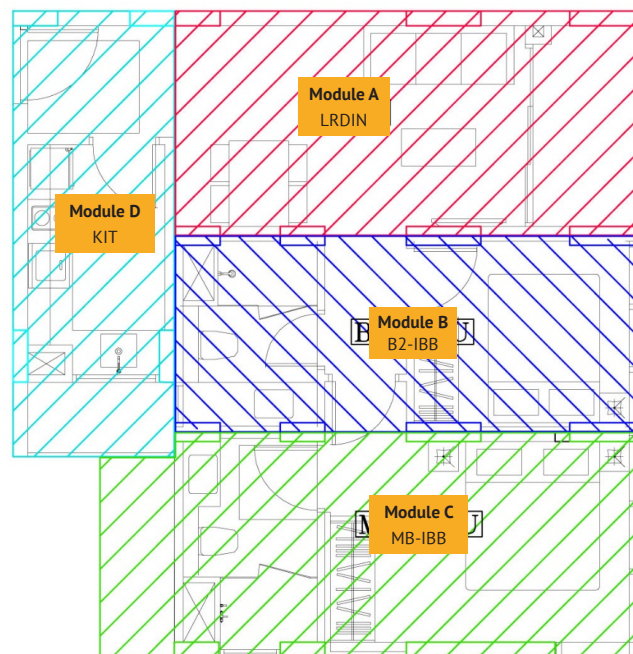

Figure: Example of A Typical 2-Bedroom Unit Modules (Plan View)

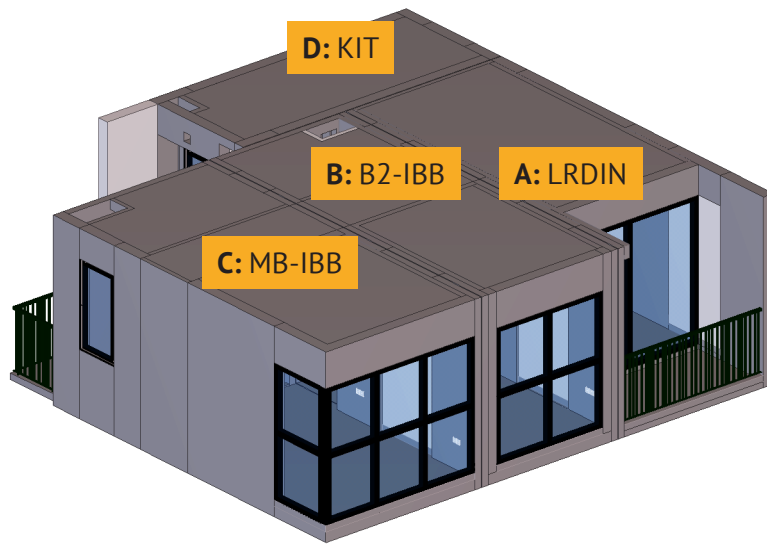
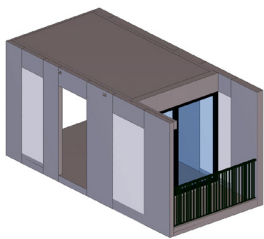
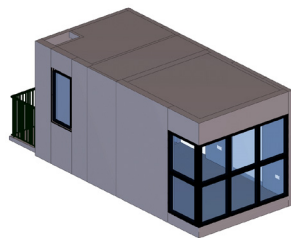

Figure : Example of A Typical 2-Bedroom Unit Modules (3D View)



MODULE A:
LRDIN
Living and
Dining Room



MODULE B:
B2-IBB
Bedroom 2
with In-built
Bathroom

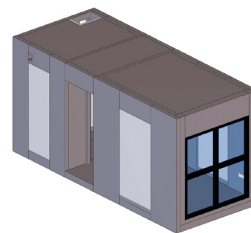

MODULE C:
MB-IBB
Master
Bedroom
with In-built
Bathroom

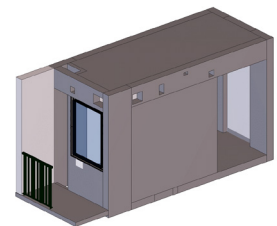

MODULE D:
KIT
Kitchen

Modules can be configured to meet the functional requirements of the building. A typical bedroom of a nursing home can constitute a total of 4 standard modules, to achieve the functional requirements.

Demarcation of a typical unit module with reference to plan below is as follows:

- **Module A:** 1MA
- **Module B:** 1MB
- **Module C:** 1MC
- **Module D:** 1MD

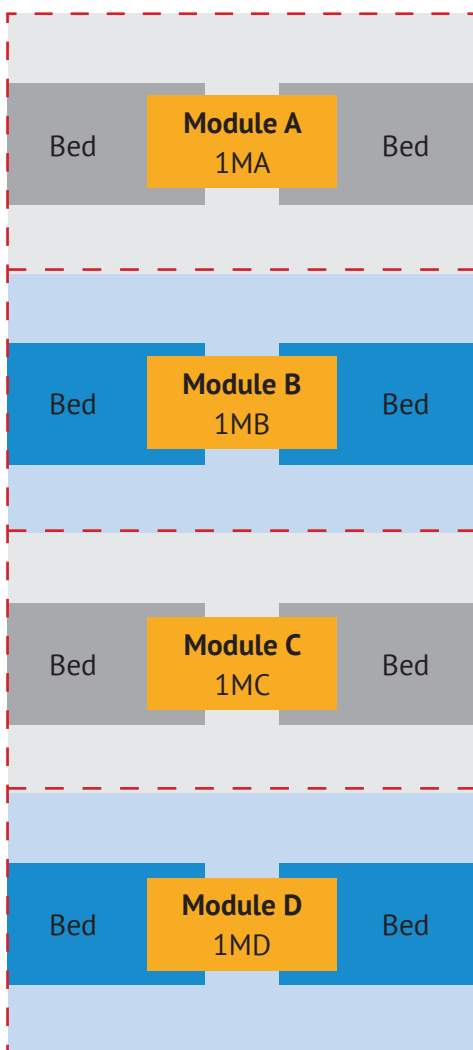

*Figure: Example of Typical Bedroom at Woodlands Nursing Home (Plan View)
Plan Courtesy of Dragages (Singapore) Pte Ltd*

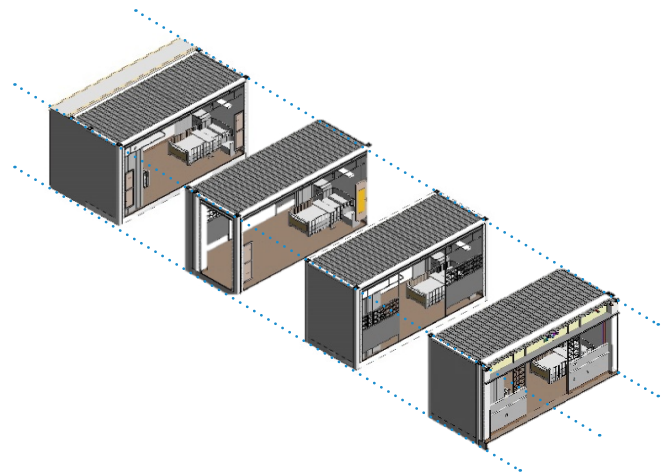

*Figure: Example of Woodlands Nursing Home PPVC modules (3D View), combined to form a bedroom
3D Courtesy of Dragages (Singapore) Pte Ltd*

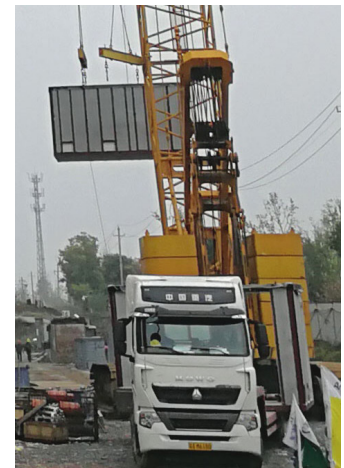

*Figure: Photo of a completed Typical Bedroom at Woodlands Nursing Home (with seamless wall and floor joints)
Photographs Courtesy of Dragages (Singapore) Pte Ltd*

2.5 Type of Hoisting Machinery

Sizing and arrangement of cranes on a site will be dictated by the total lift weight of the module and the reach of the crane.

Below are some generic information on the type of cranes available.



| Characteristic of Crane | Tower crane | Mobile crane | Crawler crane |
|----------------------------|-------------------|-------------------|-------------------|
| Crane Capacity | 50 tons | 700 tons | 500 tons |
| Lifting Capacity | 25 tons – 40 tons | 25 tons – 40 tons | 25 tons – 40 tons |
| Height of Equipment | 120m | 40m | 80m |
| Radius of work | 40m | 40m | 40m |

Note: Actual crane requirement and capacity shall vary according to the site condition and to be obtained from the crane specialist accordingly.

2.6 Comparison of Reinforced Concrete (RC) Module and Steel Module

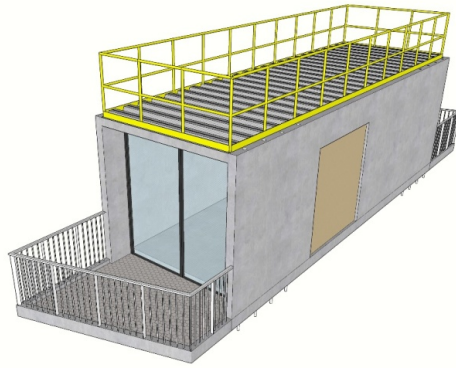

1

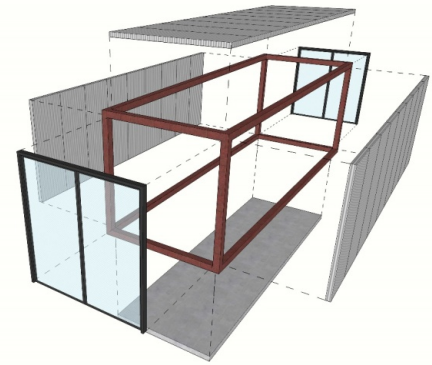

2

| | Reinforced Concrete Module | Steel Module |
|---|---|---|
| Weight | 20 to 35 tons | 15 to 20 tons |
| Handling and Transportation | <ul style="list-style-type: none"> • Protection for completed modules • Permanent / temporary roof decking • May require temporary stiffening • Require lifting frame | <ul style="list-style-type: none"> • Protection for completed modules • Permanent / temporary roof decking • May require temporary stiffening • Require lifting frame |
| Installation Method | Stacking method | Stacking method |
| Hoisting Machinery | Hoisting by crane | Hoisting by crane |
| Familiarity to Renovators in Maintenance, Replacement / Renovation Works | Similar to conventional construction | To include information of supplier manual |
| Fire Compartmentation / Rating | Similar to conventional construction | Compartmentation and use of materials shall comply with the applicable Code |
| Provision for Barrier-Free Accessibility Requirements | Similar to conventional construction | Similar to conventional construction |

Note: For reference only.

Design Considerations

3.1 Architectural Design Considerations

3.1.1 Modularisation

- At the unit layout planning and design stage, the PPVC modularisation must be undertaken in tandem with the unit layout design as early as possible. Early PPVC vendor's and engineer's involvement will be beneficial to the project. The modularisation is largely affected by the configuration, sizes, dimensions, weights of PPVC modules and ease of transportation.
- The weight of module in turn depends on the choice of PPVC material type, level of finishing, etc. The transportability of modules would be influenced by the planned delivery routes (i.e. from off-site prefabrication plants to the construction site) and types of trailers available in the industry.

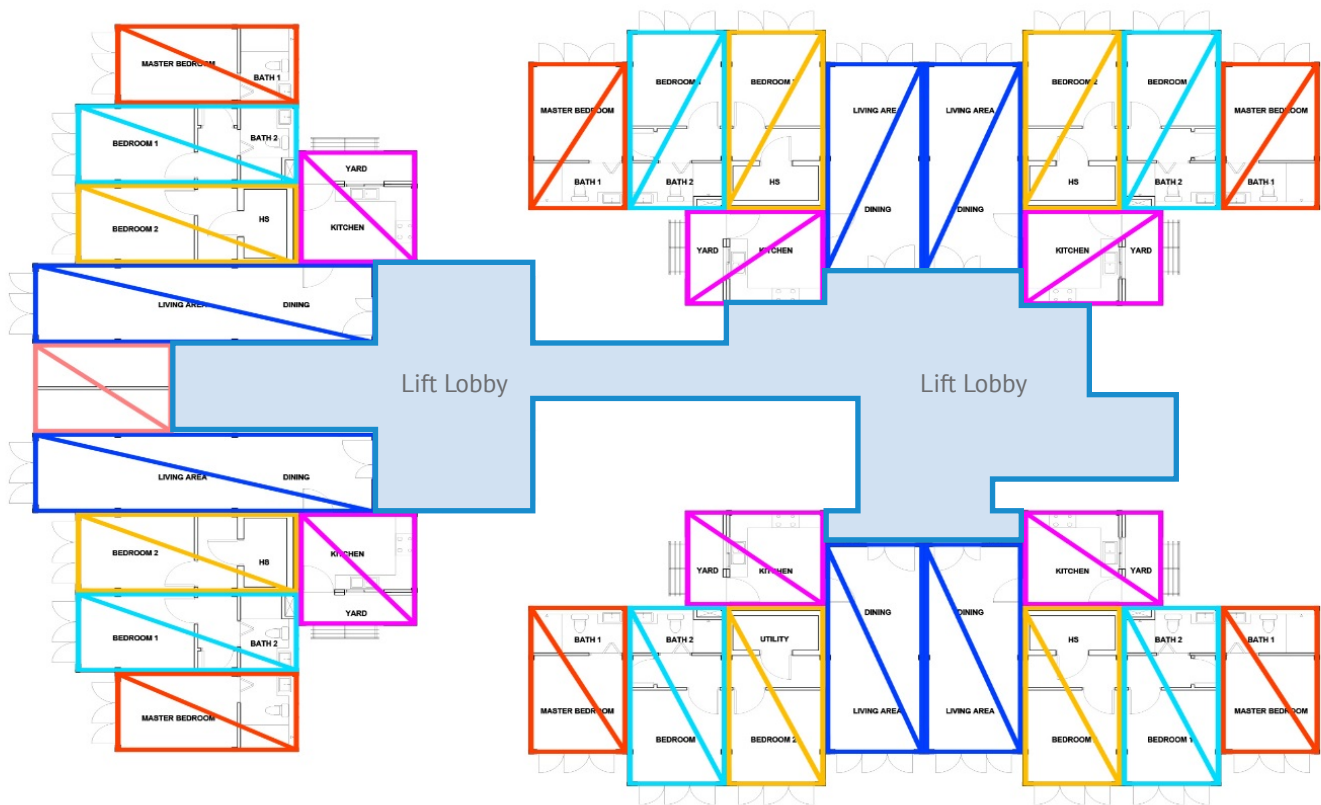

Figure: Example of PPVC modularisation during planning stage (Residential Block Plan)

3.1.2 Early Coordination

- Early coordination among Developer, Architect, Structural Engineer and MEP Engineer, Builder and PPVC specialist are essential as this will allow the team to look into the key design aspects upfront including layout design, floor and ceiling height, etc.
- With proper upfront planning to integrate PPVC into the design layout, unique designs and different building features such as curved facade and non rectangular layout can be achieved.
- To consider the removable of non-structural partitioning wall in design for future renovation.

3.1.3 Dimension on Plan

- To ensure the layout plan design comply with regulatory requirements.
- To ensure the size of modules allow transportation from factory to site.

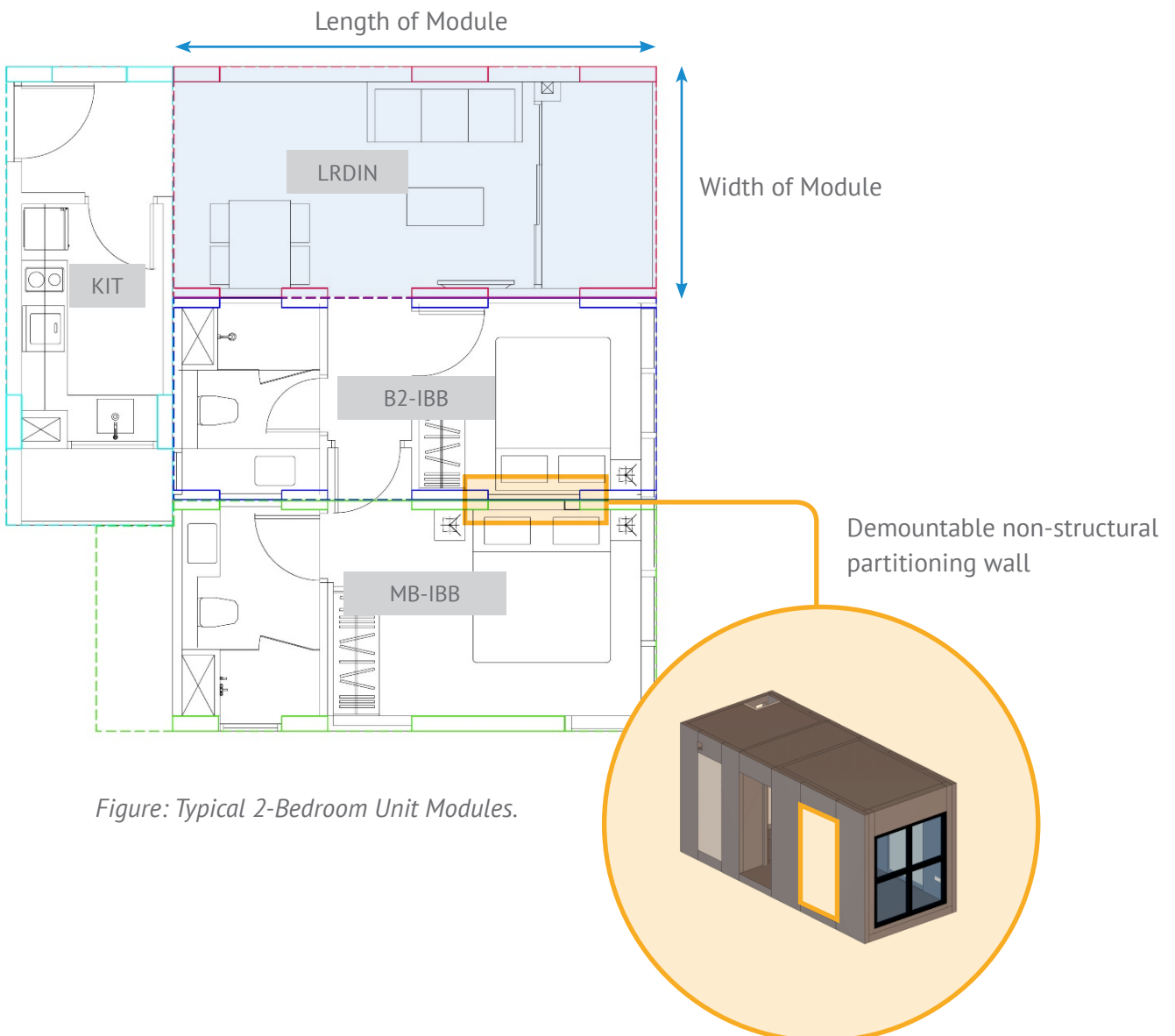

Figure: Typical 2-Bedroom Unit Modules.

3.1.4 Dimension on Section

- To ensure the floor-to-floor height comply with regulatory requirements.
- To ensure the size of modules allow transportation from factory to site.
- To comply with regulatory requirements of ceiling height.
- To consider the usage of single or double slabs.
- To maximise the useable room space and ceiling height.

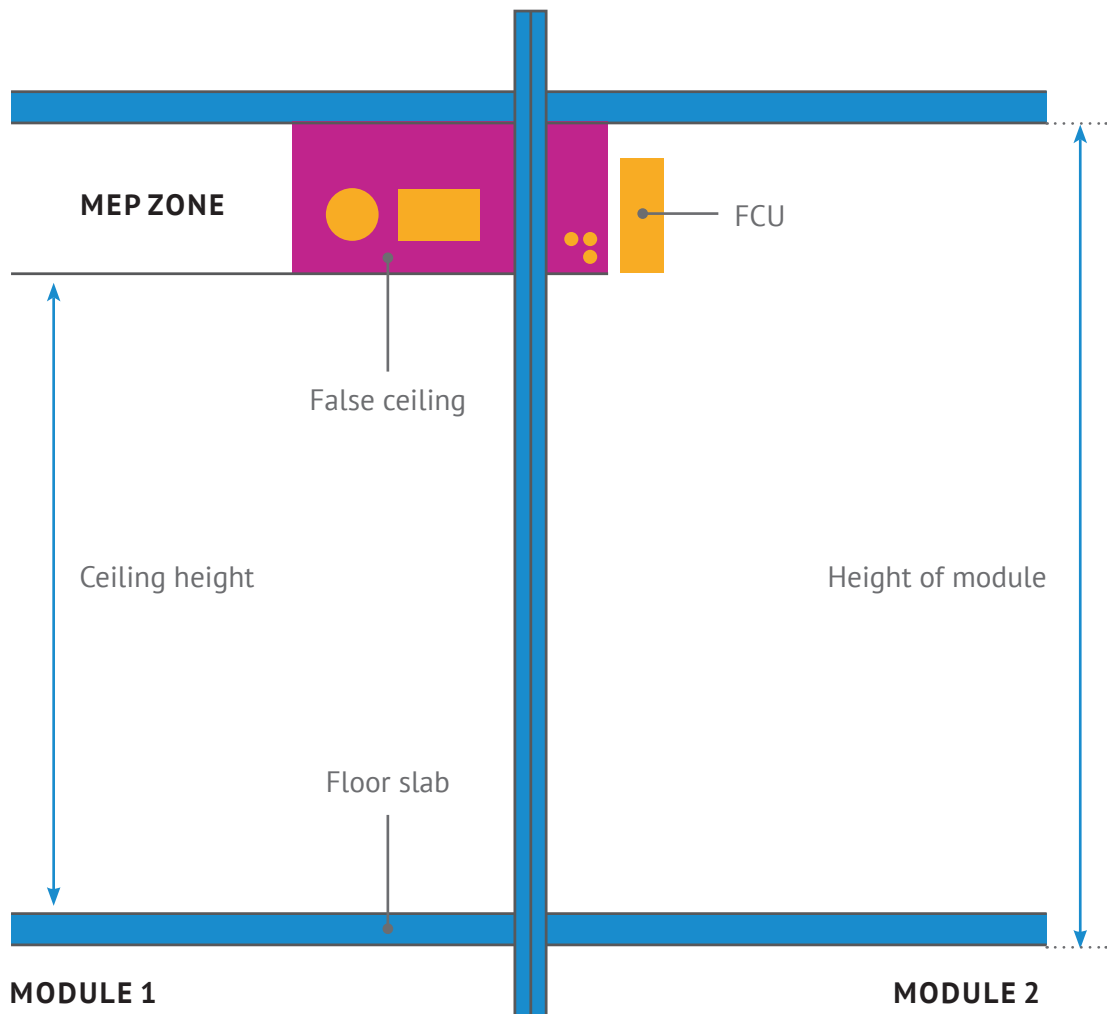

Figure: Typical Sectional Detail of Modules

Note: For reference only.

3.1.5 Vertical and Horizontal Alignment

- To consider the possible misalignment of floor, wall, ceiling at joints between modules.
- To consider the interfacing details between PPVC modules and in-situ construction such as core walls, staircases, corridors, and other portions of buildings.

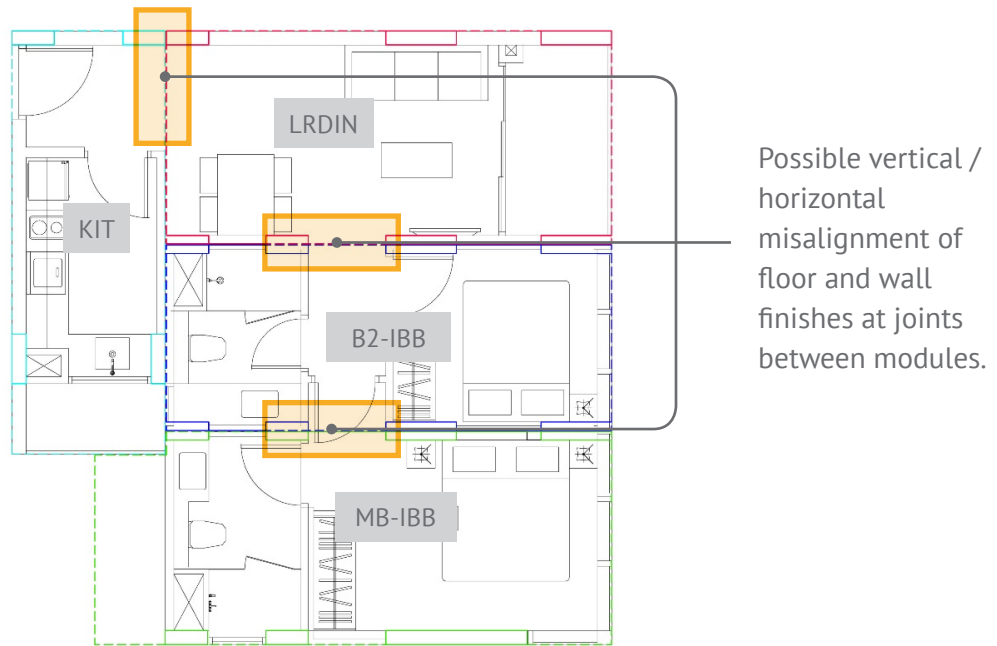

Figure: Typical 2-bedroom Unit Plan

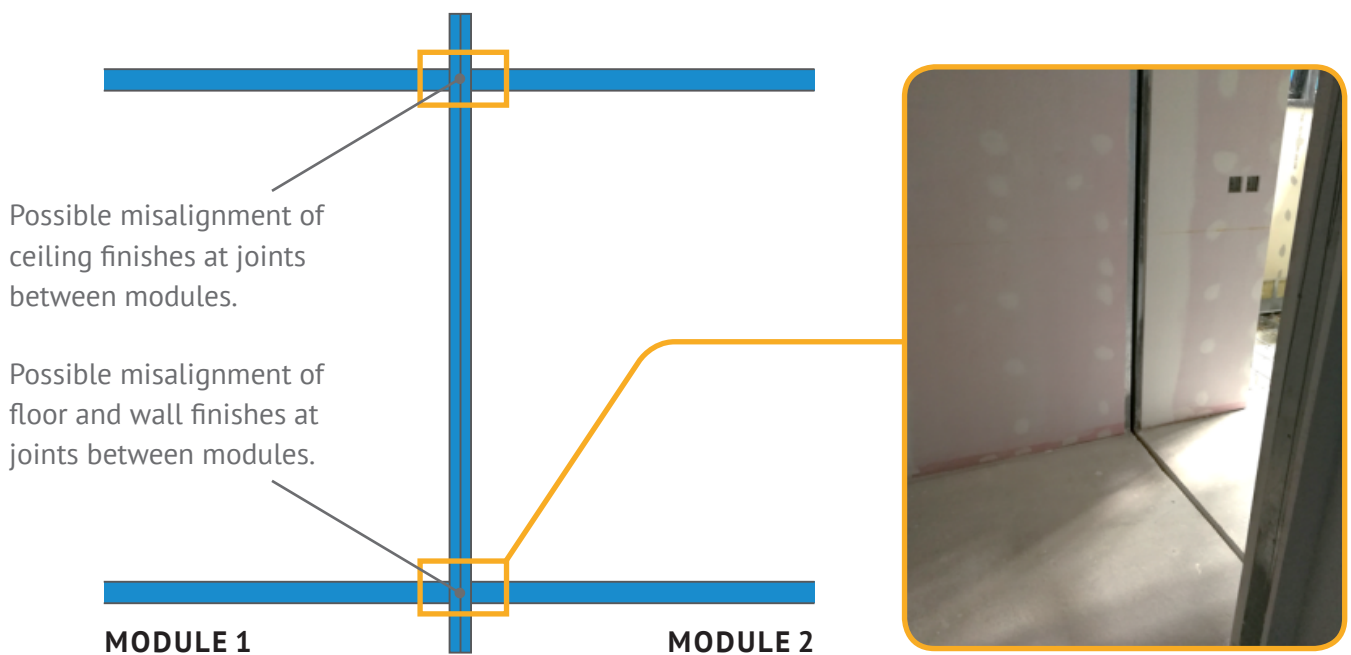

Figure: Typical Sectional Detail of Modules

3.1.6 Water-Tightness Between Modules

- To consider the water-tightness details on vertical and horizontal joints of modules

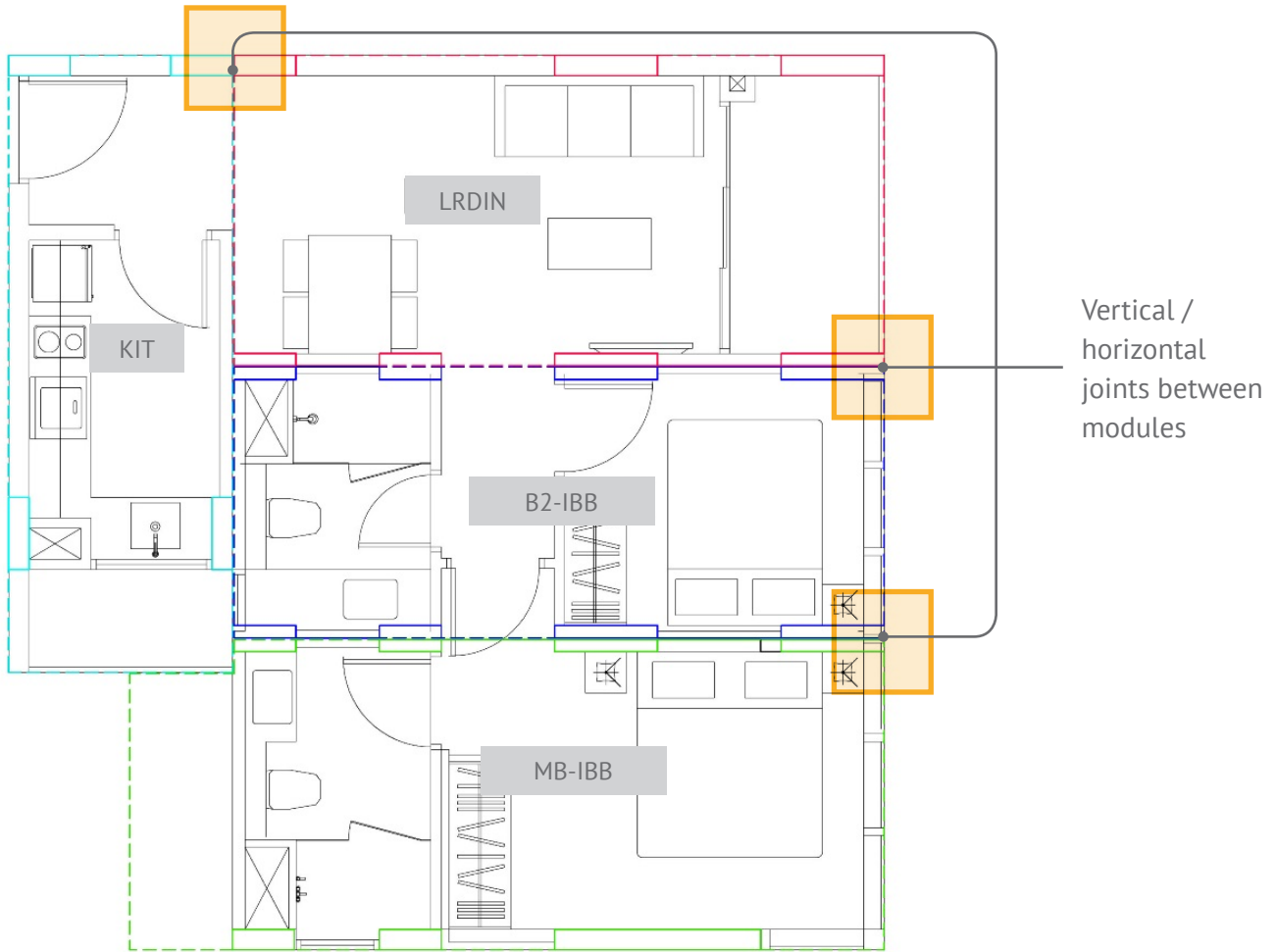

Figure: Typical 2-bedroom Unit Plan

3.1.7 Consideration of Construction Tolerance

- To consider and allow construction tolerance on vertical and horizontal joints of modules and in-situ part.

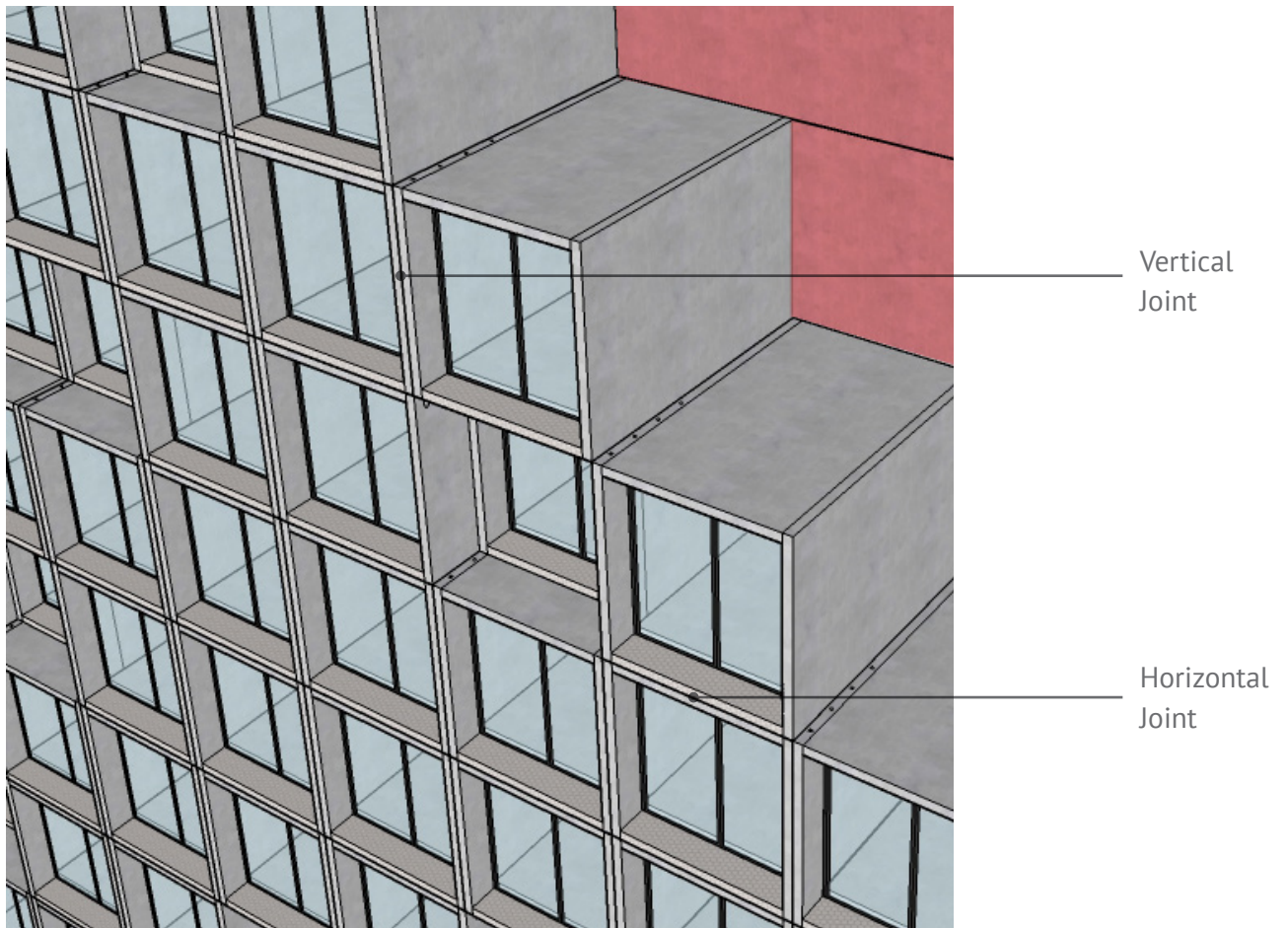

Figure: Vertical and Horizontal Joint

3.2 Structural Design Considerations

3.2.1 Structural Modelling

3D modeling of building structures shall be carried out using suitable computer analysis software. In situations where module columns or walls are abutting each other, such configuration should be considered in the 3D modeling.

In addition to the permanent design action conditions, extra modeling should be carried out to the PPVC modules with the designated number of lifting points included as temporary conditions (i.e. during hoisting operation)

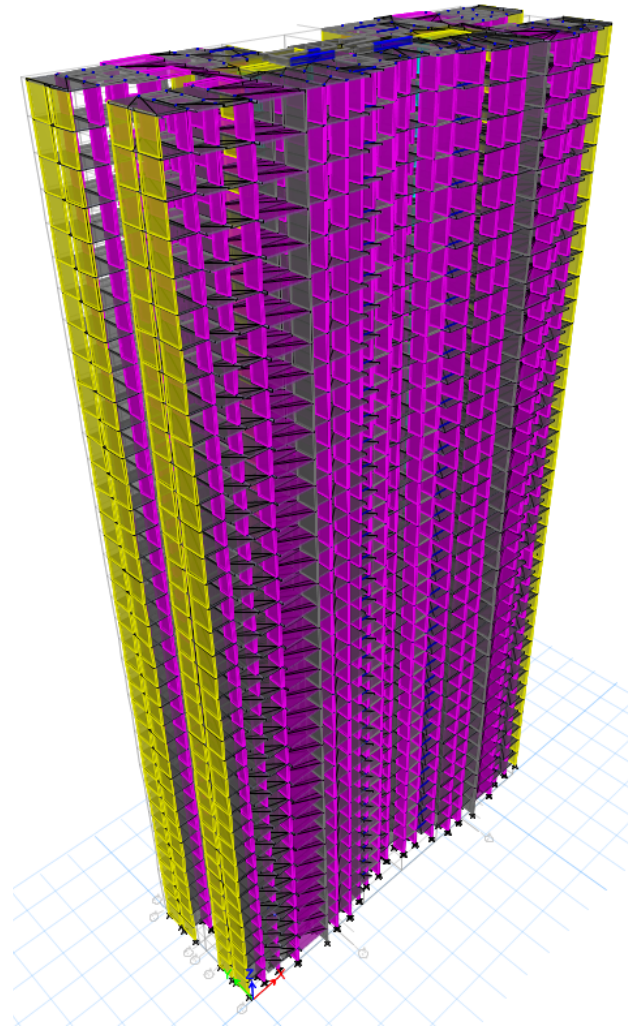

Figure: Structural Modeling For High Rise Building With PPVC

3.2.2 Vertical Modules Connection

The vertical modules connection is crucial for the structural behaviour especially for high rise buildings. They have a direct effect on the building stiffness and its corresponding response under the wind, seismic (if applicable) and lateral design action conditions. Hence, the detailing of the PPVC vertical connection must satisfy the design intent.

Vertical joints are to be designed for eccentricity or imperfection in accordance with the Building Code Requirement.

3.2.3 Horizontal Modules Connection

The horizontal modules connection forming the floor diaphragm, are equally important, contributing to the overall building stiffness. In particular, the peripheral ties and internal ties shall be provided as per the Building Code Requirements. The PPVC modules and layout shall be laterally connected and designed such that the horizontal forces (e.g. wind load) can effectively be transferred to the building's lateral load resisting system.

Due to the repetitions, and as far as practicable, the horizontal joints should be designed in a manner that the implementation at site would be speedy and simple. A classic example for steel PPVC module joints is the bolting system, whereas in concrete PPVC on-site grouting of joints is common.

3.2.4 Structural Robustness

The design of PPVC building shall give due consideration to the scenario of sustaining an extent of localised failure without disproportionate collapse. The inter-connected volumetric system must be capable of redistributing the internal forces to the nearest load bearing elements such that progressive collapse is totally prevented.

Provisions for structural robustness may involve providing effective horizontal and vertical ties, notional removal of one column / nominal section of wall or designing such elements as a "key element" or systematic risk assessment in accordance with the building's Categorisation of Consequences Classes as per relevant EN 1991-1-7 provisions.

3.2.5 Modules Connection To Civil Defence Shelter Wall

It is mandatory for residential building projects to incorporate either Household Shelters (HS), Storey Shelters (SS) or Staircase Storey Shelters (SSS) as Civil Defence (CD) Shelter. In situation where PPVC modules are abutting the CD shelter, effective connection for load transfer between the abutting PPVC modules and CD shelter walls at each storey level is to be provided. The connection details should take into account the construction sequence of shelter walls, launching of precast staircase flights (for SSS), casting of shelter floor slab and installation of abutting PPVC module(s), hollow cores formed in the precast hollow core shelter walls, as well as the installation of steel reinforcement cages inside the hollow cores at site.

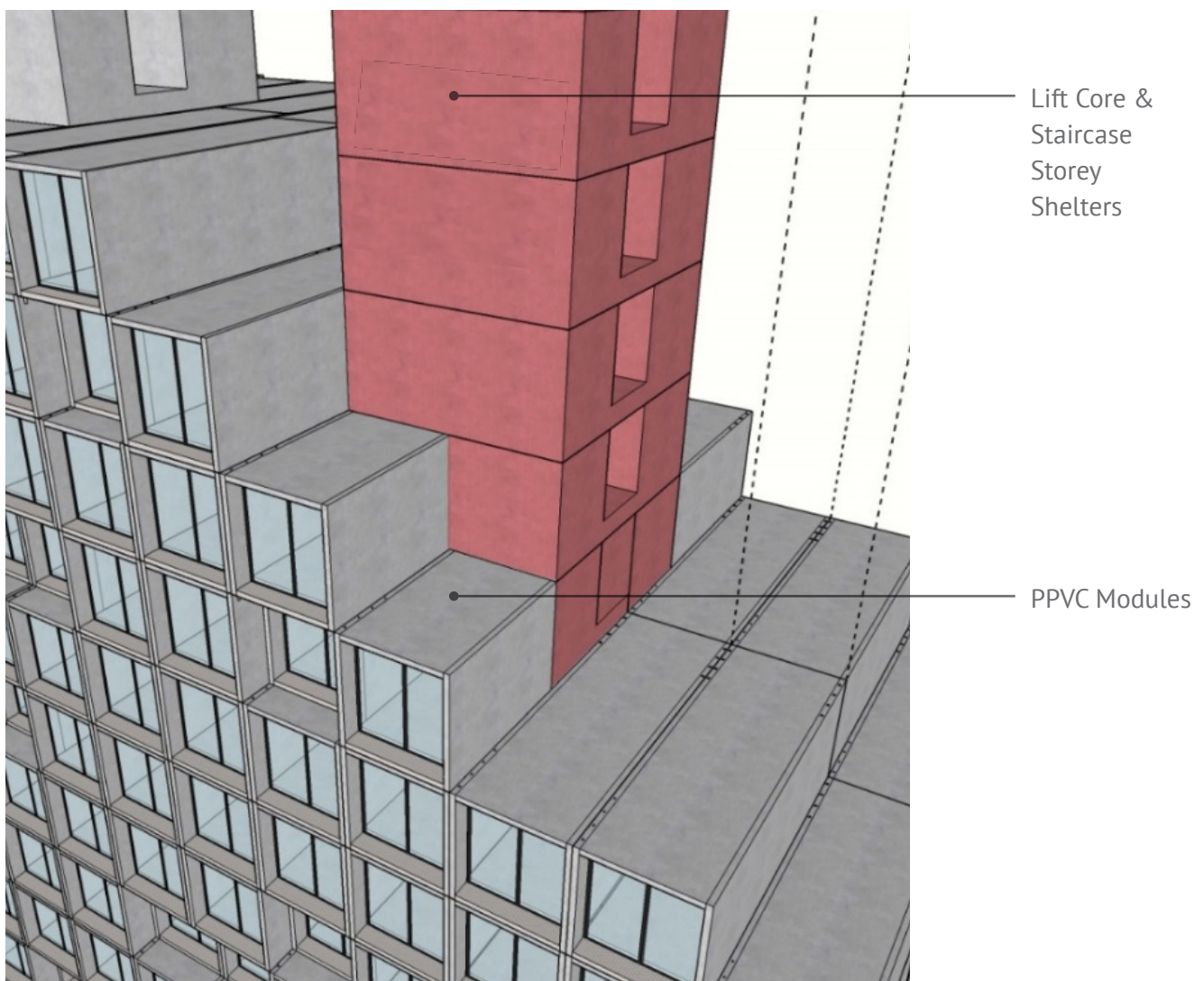

Figure: Modules Connection to Civil Defense Shelter.

Note: To Refer to Relevant Technical Requirements

3.2.6 Structural Design of Modules

In addition to the normal elemental design under the permanent design actions, it is necessary to carry out structural analysis of transient design situation (e.g. during handling in the prefabrication plant) to the PPVC modules considering the designated lifting points during hoisting and erection. Serviceability limit checks should be performed to prevent cracks to the concrete slab, walls or steel frame distortion during handling and transporting.

The lifting points must be strategically positioned such that sufficient bond anchorage can be developed to hoist the entire module safely and that the load distribution to all lifting points is reasonably uniform. It is a good practice to hoist PPVC module with the aid of steel collar frame so that the module would not be subject to inclined forces from the lifting wires.

Broadly there are two types of framing system for concrete PPVC modules, namely:

- a. Beam-Column system, in which the beam profiles may be visible without false ceiling.
- b. Slab-Shear wall system, in which no beam is required for the module framing

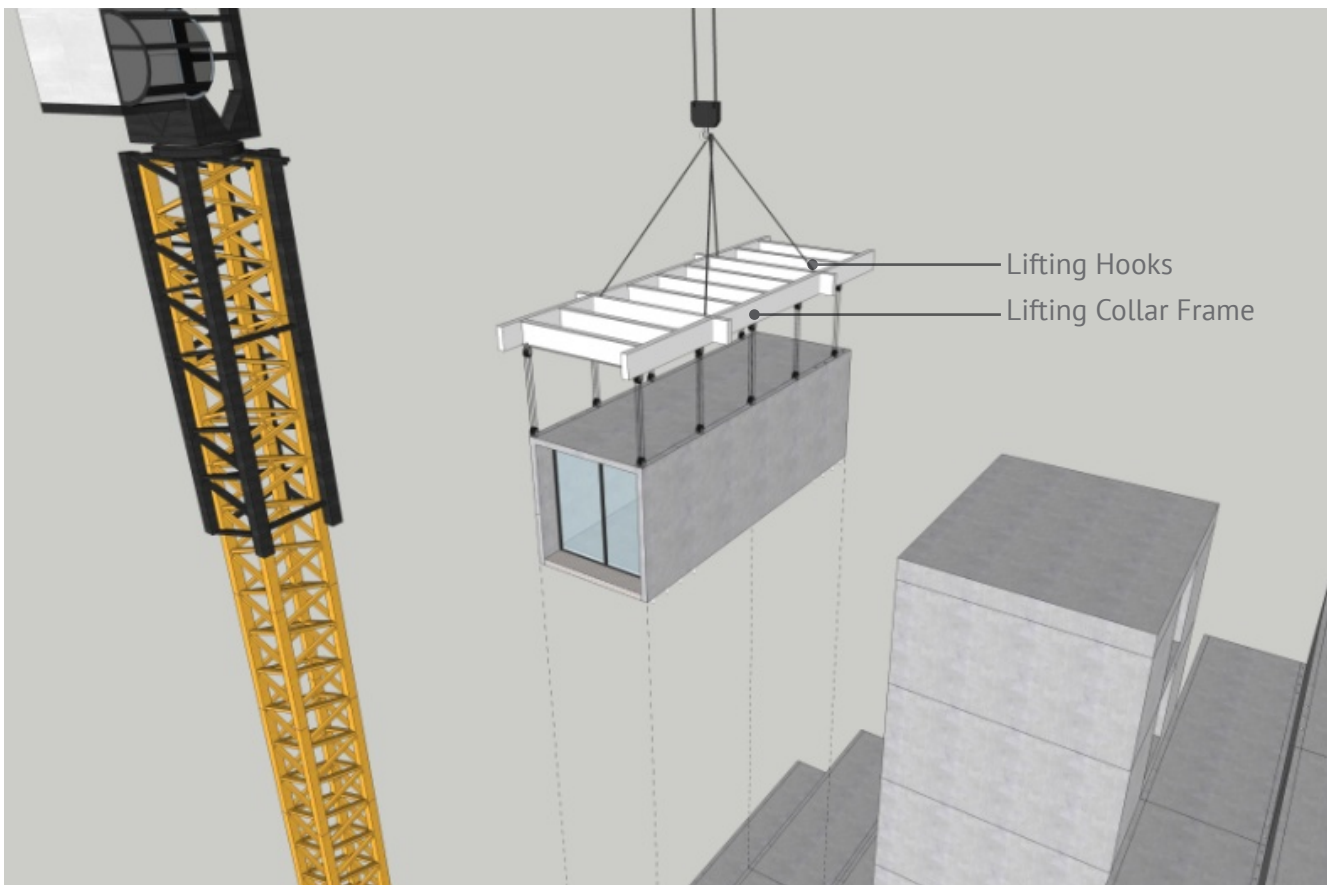

Figure : Modules with Lifting Collar Frame and Hooks

3.2.7 Periodic Structural Inspection (PSI)

Periodic Structural Inspection (PSI) is a requirement for all buildings, be it steel or concrete. However, for Steel PPVC modules, there is an additional access panels with inspection points required to conduct the inspection on critical structures such as steel beams and column joints. These inspection points and the proposed inspection methodologies shall be identified at the onset and be included in the structural plans for fabrication and for authority submission.

To minimise the inconvenience to the building occupiers when the Structural Inspector conducts the inspection in future, these inspection points shall be strategically planned and located at areas that are discreet such as balconies, ac ledges, kitchens or common corridors.

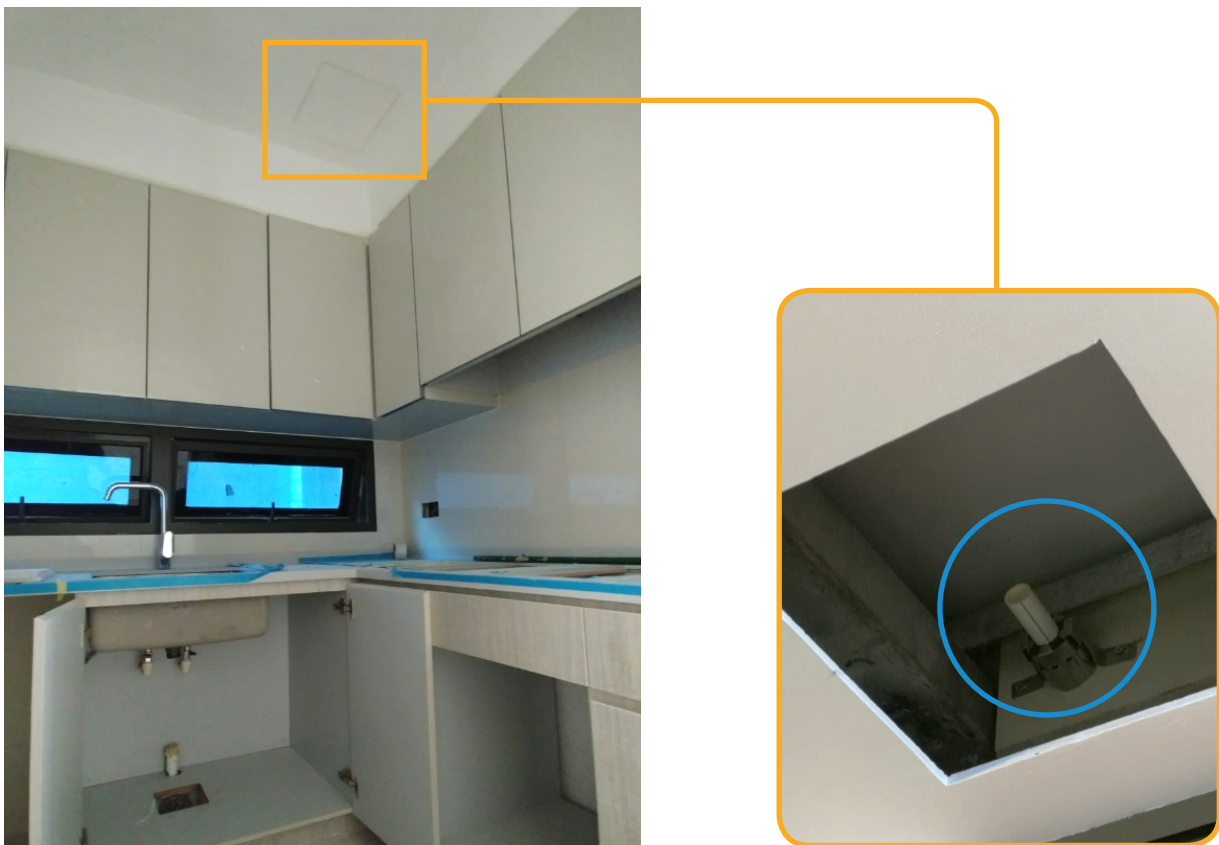
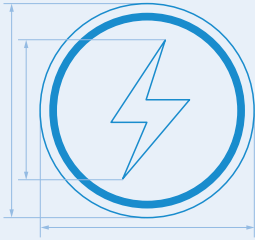

Figure: Example of PSI Point Provision

Photographs Courtesy of Surbana Jurong Pte Ltd and Moderna Homes Pte Ltd

3.3 Mechanical, Electrical and Plumbing (MEP) Design Considerations



TYPICAL MEP SERVICES

Electrical, lightning protection, water supply, sanitary, ACMV, gas, and any other system are part of PPVC.

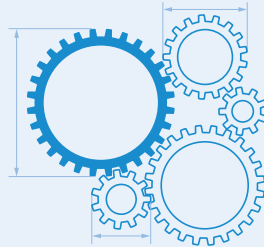

MEP COORDINATION

Early coordination of services will be advantageous. Constraints for installation and maintenance should be addressed early to avoid impact on pre-finished works in the later stage. Upfront design coordination in conjunction with structural prefabrication component is important.

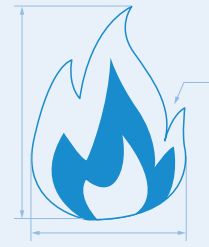

IMPACT TO STRUCTURE AND FIRE SAFETY

Necessary openings, recesses and concealed components shall be included in consideration for structural strength, fire safety measures and other relevant design.

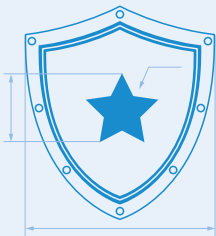

INTEGRITY OF MEP SERVICES

Continuity and system integrity of all MEP services shall be taken care of. Due to the modularisation nature of PPVC, connection of MEP system components between modules may be required. Connection methodology shall not compromise integrity and performance of the system.

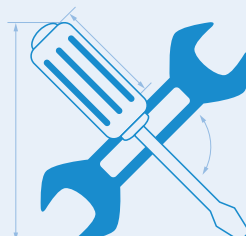

ACCESSIBILITY FOR INSTALLATION AND MAINTENANCE

Means of installation shall enable ease of maintenance or future replacement when necessary. Space for installation, maintenance and future replacement shall be allocated. Pipework enclosures (e.g. ducts, castings, etc.) shall be of a suitable size. Sufficient and suitable ready access shall be provided for maintenance, inspection, testing and repairing / replacing of the enclosed pipework.

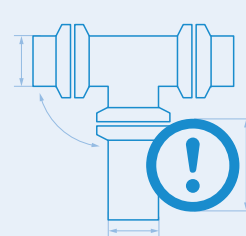

DESIGN AND CONSTRUCTION ERRORS

Tolerance of gradient of pipe-works connections shall be considered. Angle and leveling of fittings may be affected after the module is positioned in-place. Design and planning shall consider tolerance of these level differences.

MEP Design Considerations

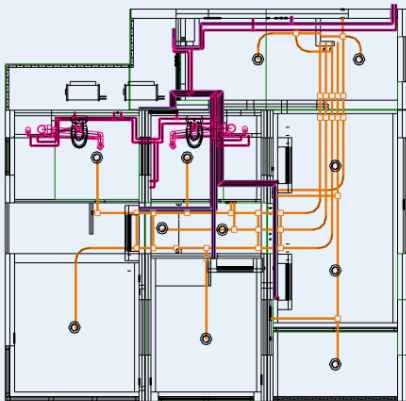
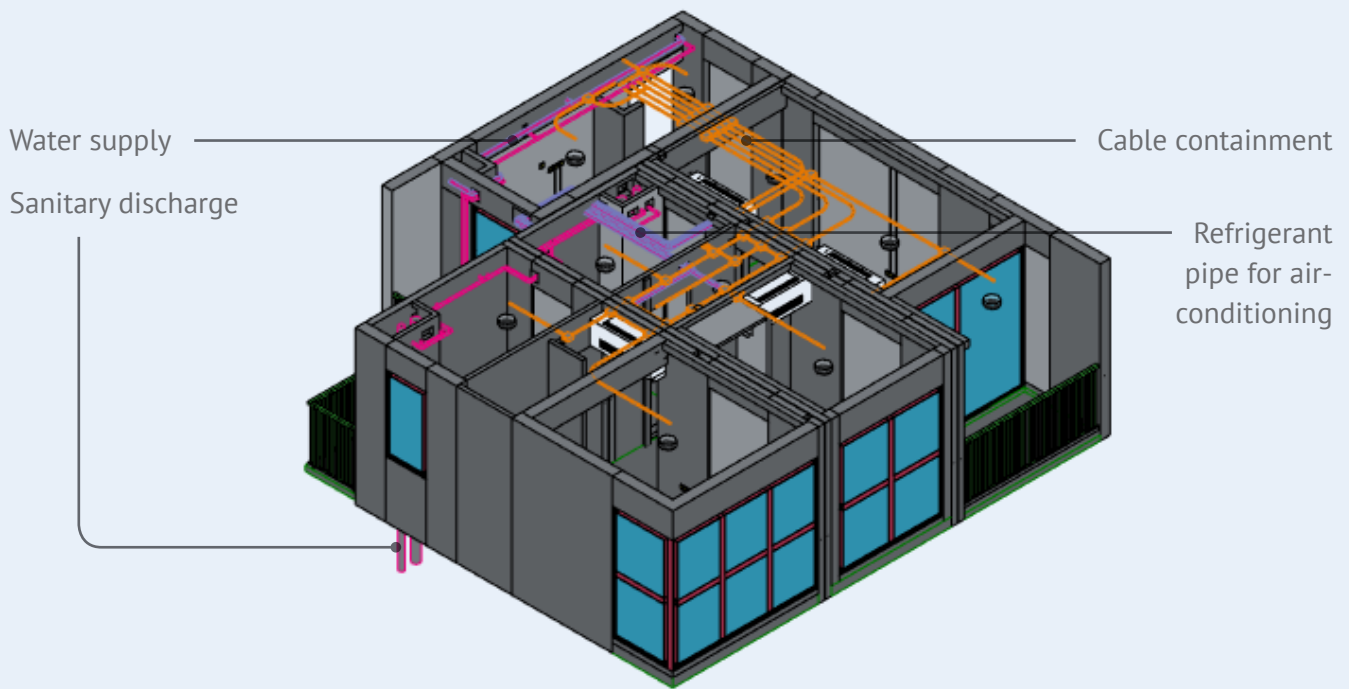

PLAN

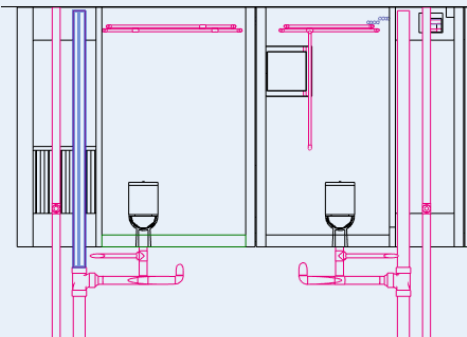

SECTION



Figure: Sample of Concealed Services in the Ceiling Space

3.3.1 Electrical

- Connection of components including conduit, cable trunking and cable trays.
- Joint of cable infrastructure between modules to ensure proper protection for cable.
- Joint of cable shall ensure complete continuity with acceptable connection methodology, if joint of cable is unavoidable.
- Concealed cable infrastructure not to compromise fire safety.

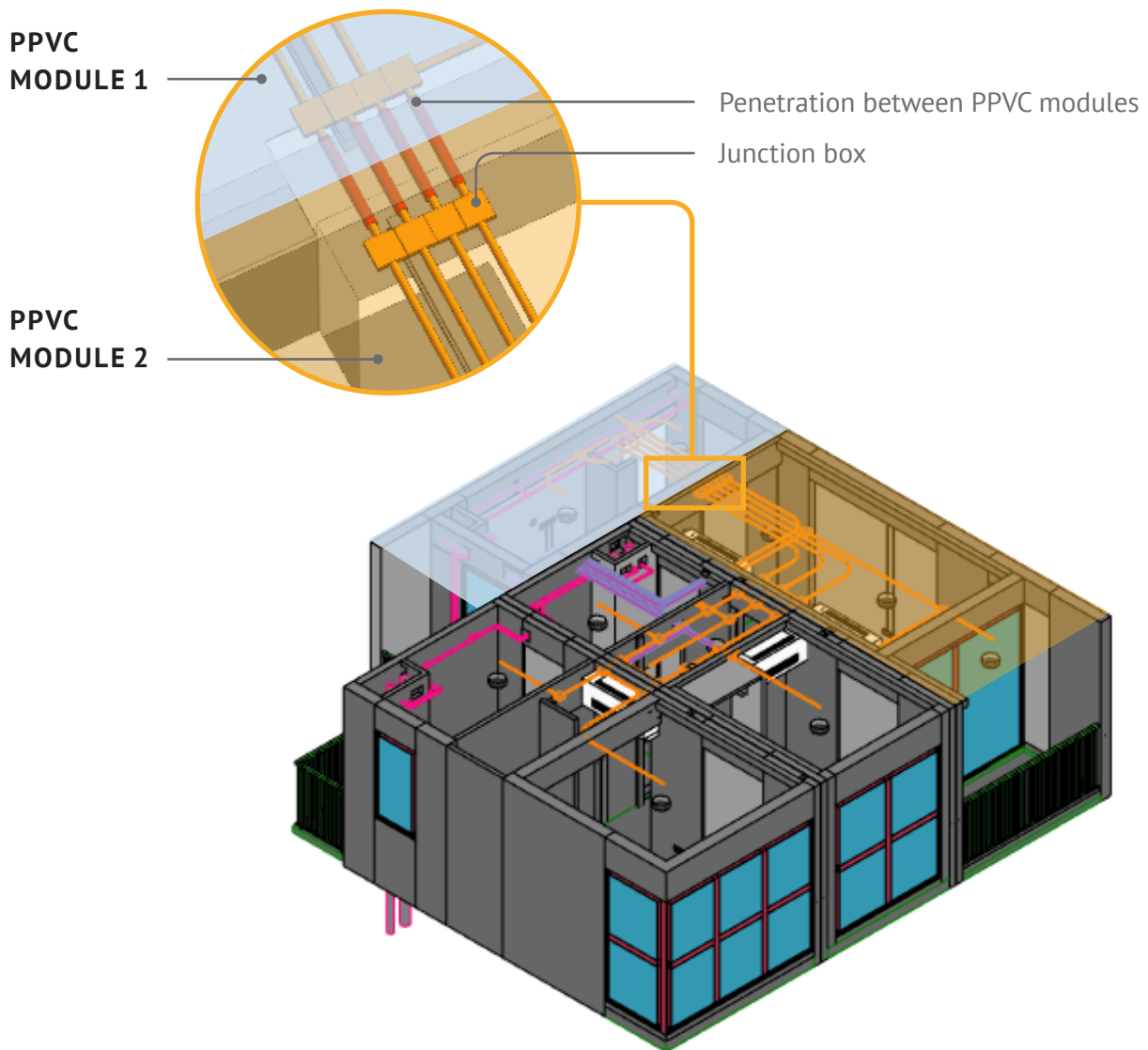

Figure: Electrical Services

3.3.2 Lightning Protection

- Connection of lightning conductor.
- Connection joint shall ensure proper conductivity with acceptable methodology.
- If structure rebar and/or structural steel section is used as conductor, proper measures to be taken to prevent erosion of conductor.

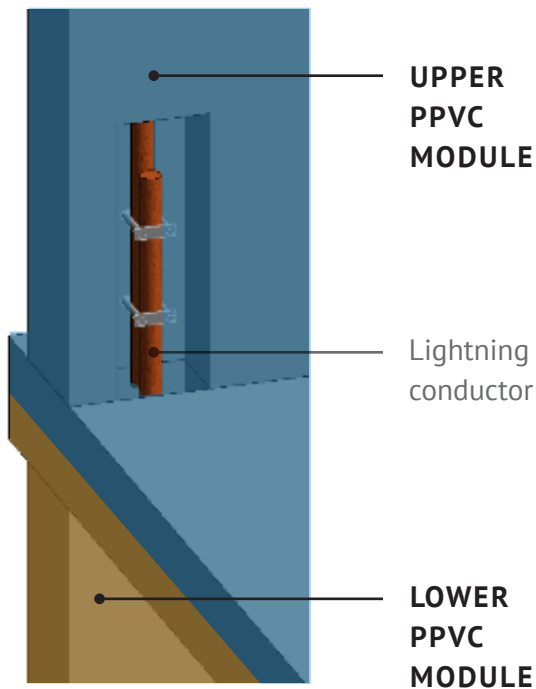

Figure: Lightning conductor connection between modules

3.3.3 Water

- Water fittings that are to be concealed shall be water-tight and suitable for the default conditions (e.g. pressure, temperature and etc), which is likely to be encountered by the water fittings.
- Concealed components embedded in structural elements shall be taken into consideration for structural strength design.

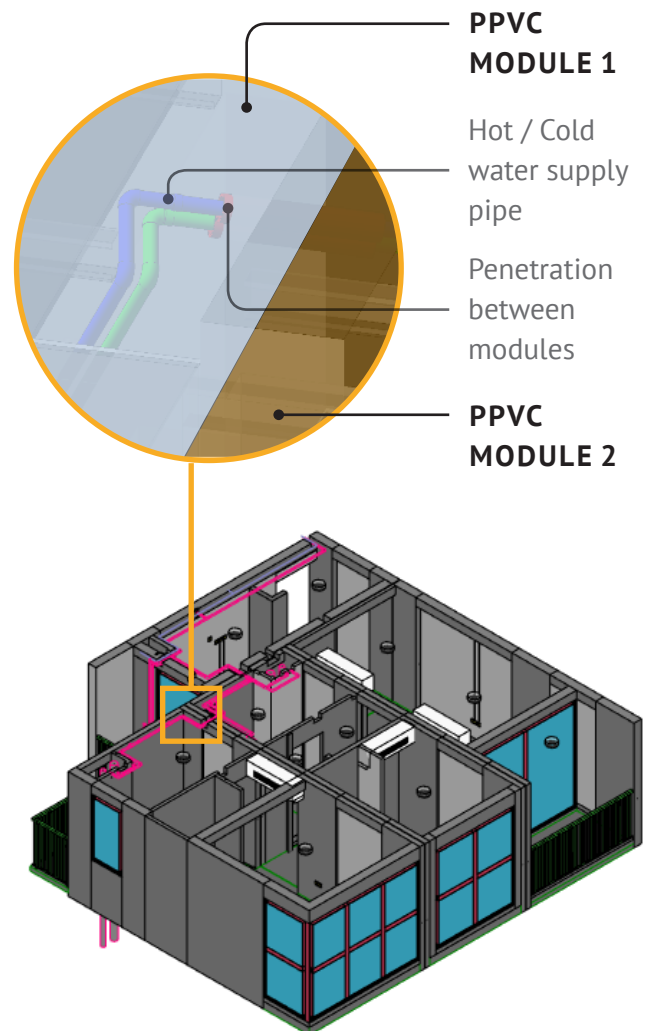

Figure: Water supply routing and connection between modules

3.3.4 Sanitary

- All sanitary discharge pipes and ventilating pipes shall be laid in accordance with PUB and Code of Practice requirements.
- All gravity discharge pipes shall have suitable gradient to maintain self-cleansing velocity to ensure smooth flow.
- All joints of pipes shall be tested to ensure water-tightness and air-tightness.
- Shallow floor trap shall be of the suitable type and comply with the performance standards prescribed by PUB. For shallow floor trap requirements, please refer to Code of Practice on Sewerage and Sanitary Work.
- Shallow floor trap shall not be used if there are connections from kitchen sink or dishwasher.
- To consider potential slab thickening factor for use of shallow floor trap (subject to regulatory compliance and approval), including impact on weight, transportation and storage requirements.
- Proper protection to all protruding and exposed pipeworks from mechanical damage during transportation, storage and shifting of modules.
- To protect pre-installed pipeworks from heat, ultra-violet radiation and other possible detrimental factors.
- Concealed components embedded in structural elements shall be taken into consideration for structural strength design.
- To ensure suitable access and working space provided for pipe connection between modules.
- Method for future repairing works for clogging or leakage shall be taken into consideration in the design.
- To consider mounting type of WC (floor-mounted or wall-mounted).

Sanitary

CONVENTIONAL FLOOR TRAP

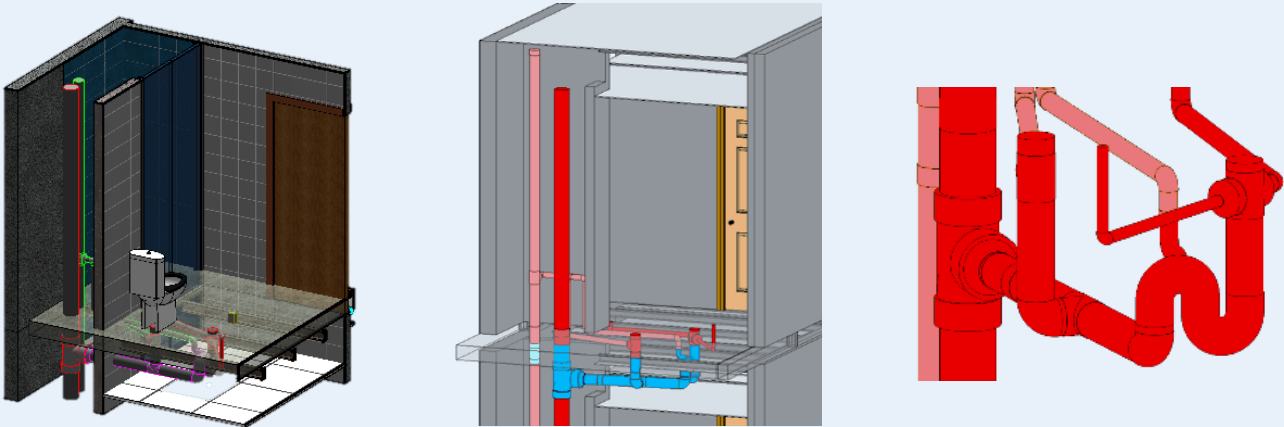

SHALLOW FLOOR TRAP

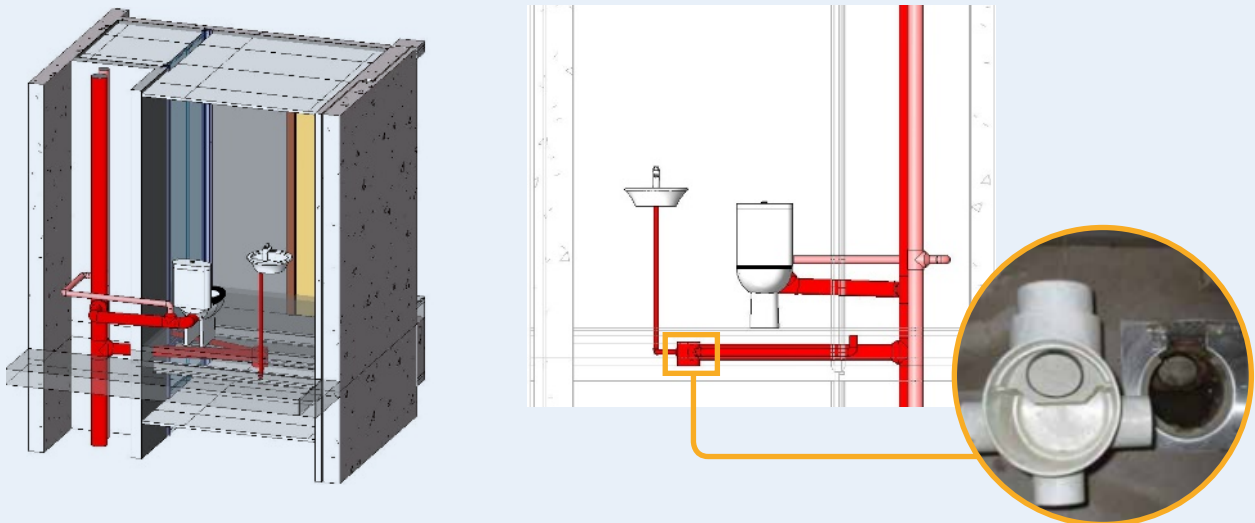

3.3.5 Air-Conditioning and Mechanical Ventilation

- Connection of air-conditioning components including refrigerant pipe, condensate drain pipe, respective insulation layer, and wiring.
- Joints of refrigerant pipe, if required, shall be able to withstand operating pressure and not be eroded easily.
- Maintenance and repairing measures shall be taken into consideration.
- Connection of mechanical ventilation components including mechanical fan, air-duct and wiring.
- Inspection and replacement access for equipment such as mechanical fan shall be reserved.

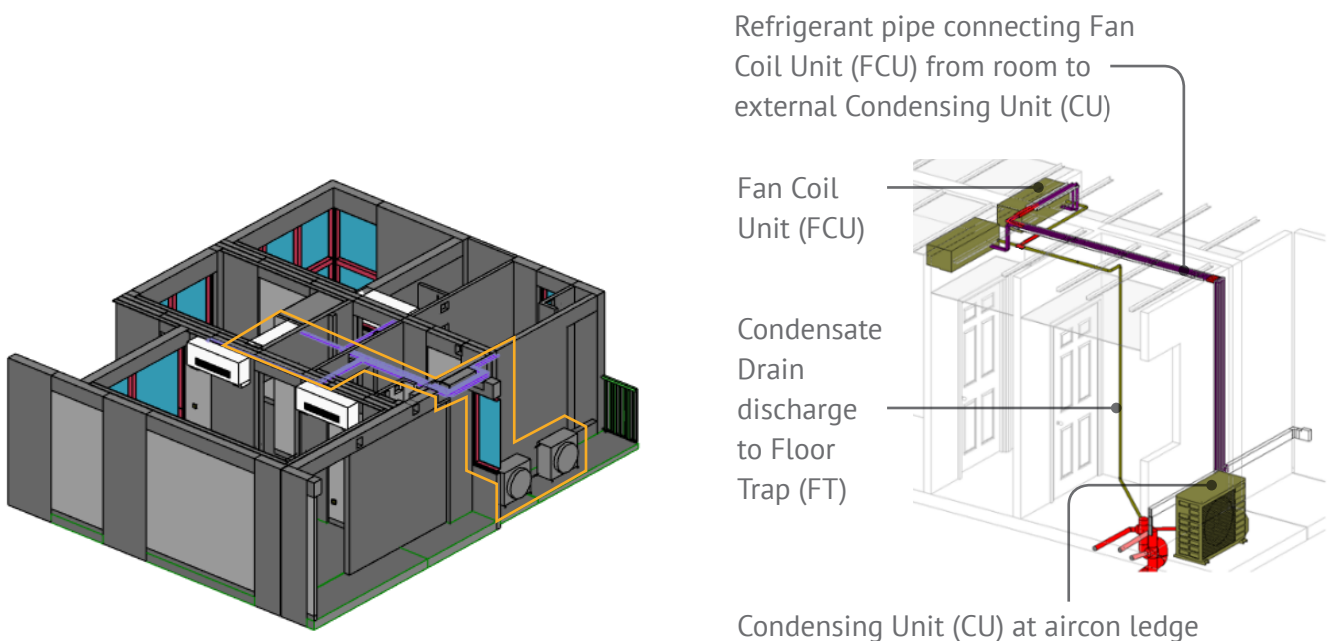

Figure: Air-conditioning and MV Routing

3.3.6 Town Gas

- Connection of town gas supply shall be able to withstand town gas supply pressure and free from leakage.
- Joints shall be treated as necessary to prevent corrosion.
- Concealment, if any, shall be subject to regulatory approval.

3.4 Compliance with Fire Safety Requirements

The design, construction and installation of the proposed PPVC system for building construction shall comply with the fire safety requirements stipulated under the Fire Code.

3.4.1 Compliance of Fire Compartmentation

- To comply with fire resistance rating required for the elements of structure of the building.
- The typical compartment floor between floor levels shall comply with the required fire resistance rating in accordance with the Fire Code requirements for the compartment floor which is an element of structure.
- The compartment walls segregating the dwelling units as well as segregating the dwelling units and fire fighting lobby shall comply with the required fire resistance rating in accordance with the Fire Code requirements.
- Provision of documentary proofs and detail drawings to illustrate compliance of Fire Code requirements of the proposed system in terms of compartmentation, material usage, etc. is required.

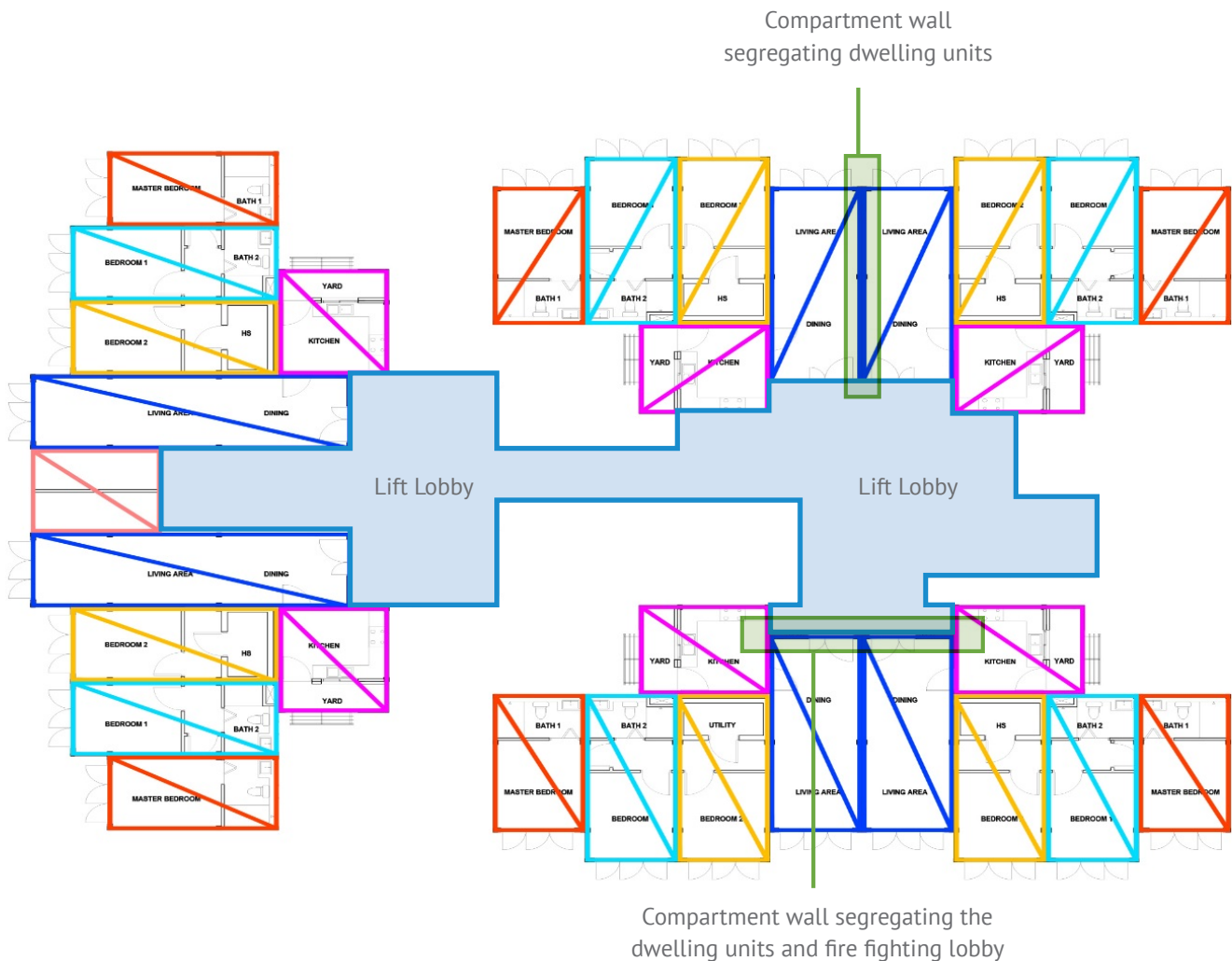

Figure: Example residential tower block plan – Compartment walls

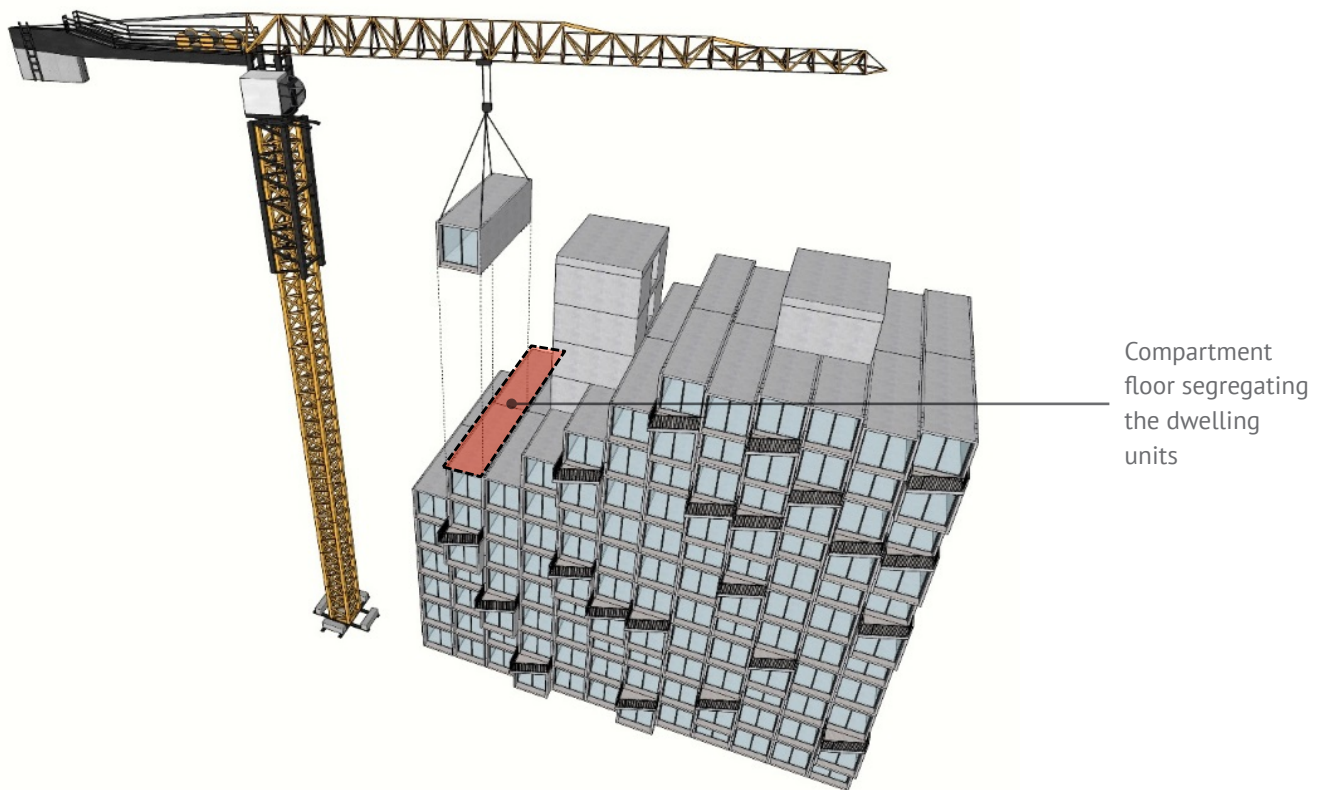

Figure: Example of 3D Modules – Compartment floors

3.4.2 Compliance of Use of Material

- Use of materials has to be considered to ensure the integrity of PPVC modules.
- To comply with the fire safety requirements for the use of plastics in building construction and the fire safety requirements for incorporating services within fire-rated dry construction in buildings.
- The use of building products/materials/systems shall comply with the fire test performance requirements stipulated in the fire safety guidelines for certification of regulated fire safety products/materials of the Fire Code. Fire test performance reports from accredited test laboratories & Certificate of Conformity (COCs) / Declaration of Compliance (DOC) for regulated fire safety products from Certification Bodies (CBs) accredited by Singapore Accreditation Council (SAC) shall be provided for the proposed products/materials/systems.
- If overseas accredited testing laboratory recognised by Singapore Accreditation Council (SAC) is engaged to conduct the fire performance tests for the proposed products/materials/systems, the test performance reports shall be certified by any of the accredited Certification Bodies (CBs) in Singapore before they can be used for building construction in Singapore.
- To consider early engagement of the certification body and registered inspector (RI) to conduct factory inspection at the overseas manufacturing plant for certification and conformity of regulated fire safety products/materials/systems.

PPVC Module Production

4.1 Reinforced Concrete (RC) PPVC Production

4.1.1 Mould Process

Moulds are fabricated in steel with comprehensive design to withstand the handling and production process for the lifetime required in production. These moulds are three-dimensional and may be adjusted to cater for several combinations of dimensions. The factors that influence the concept of mould design are as follows:

1

Mould design

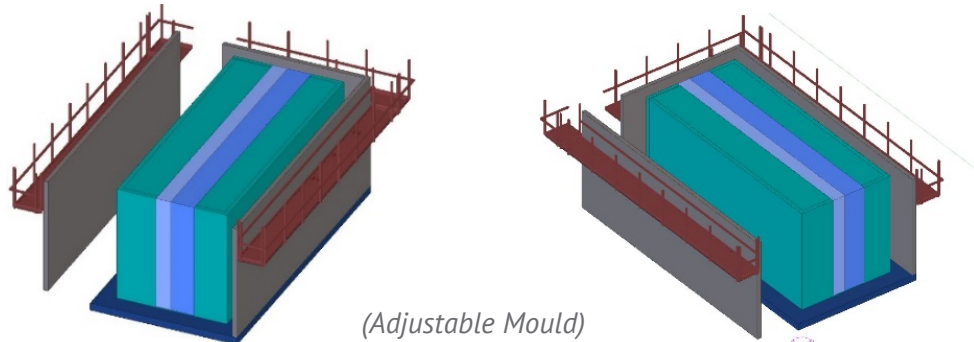

2

Mould fabrication



3

Mould delivery to factory and setting up at factory

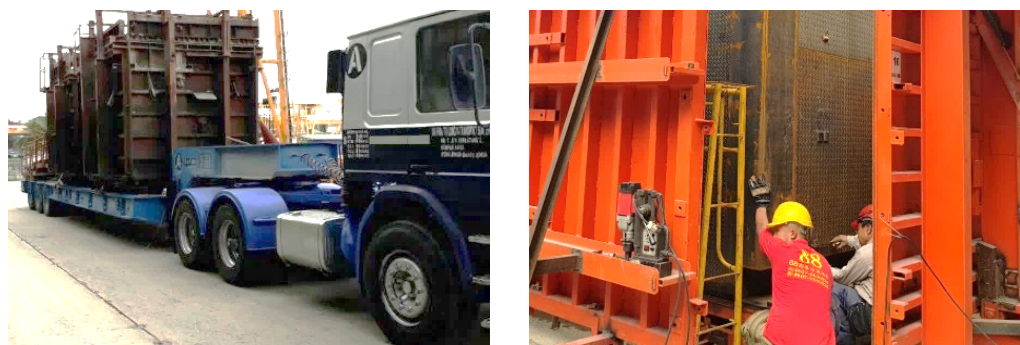

4.1.2 Structural and MEP Works

Reinforced Concrete modules can be produced by integrating structures like column, beam, wall and slab as a single module. The production process comprises of the following steps:

1

Reinforcement cage fabrication

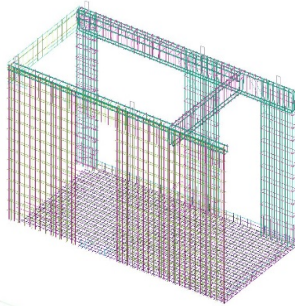

2

Installation of MEP and other cast-in items



3

Inspection prior to concreting

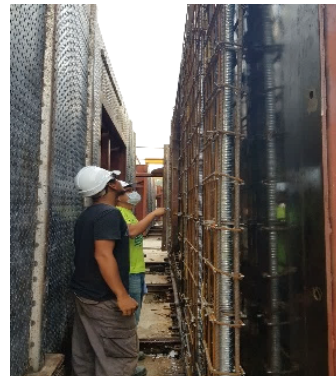

4

Concreting works



5

Upon completion of curing, demoulding and post-pour inspection



6

Demoulding and hoist up of the modules

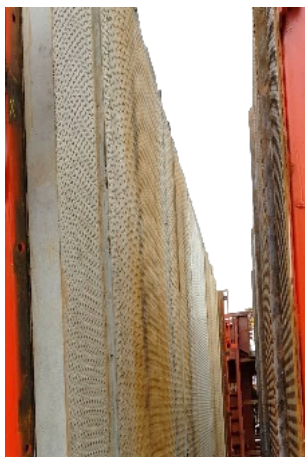

Shifting / turning and storing the modules

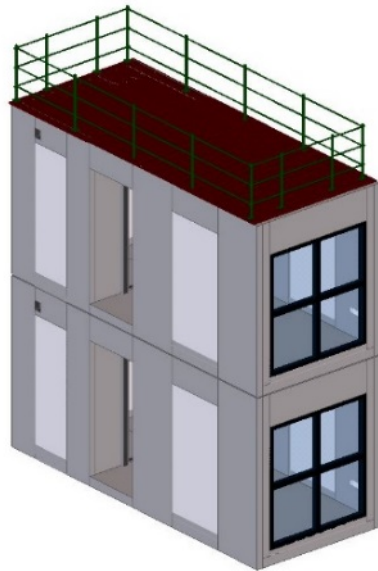

Upon the completion of the shell, there shall be a trial assembly off-site to check the vertical and horizontal alignments, as well as the check on the continuity of the MEP services. Water (hydrostatic) test and air-pressure test in accordance with PUB's requirements shall be carried out on all sanitary pipes prior to Architectural works.

4.1.3 Architectural Finishing and MEP Works

The architectural works shall be executed under the sheltered environment, by trained specific trades off-site. The works shall comprise the following in the sequence of execution and on levelled platform.

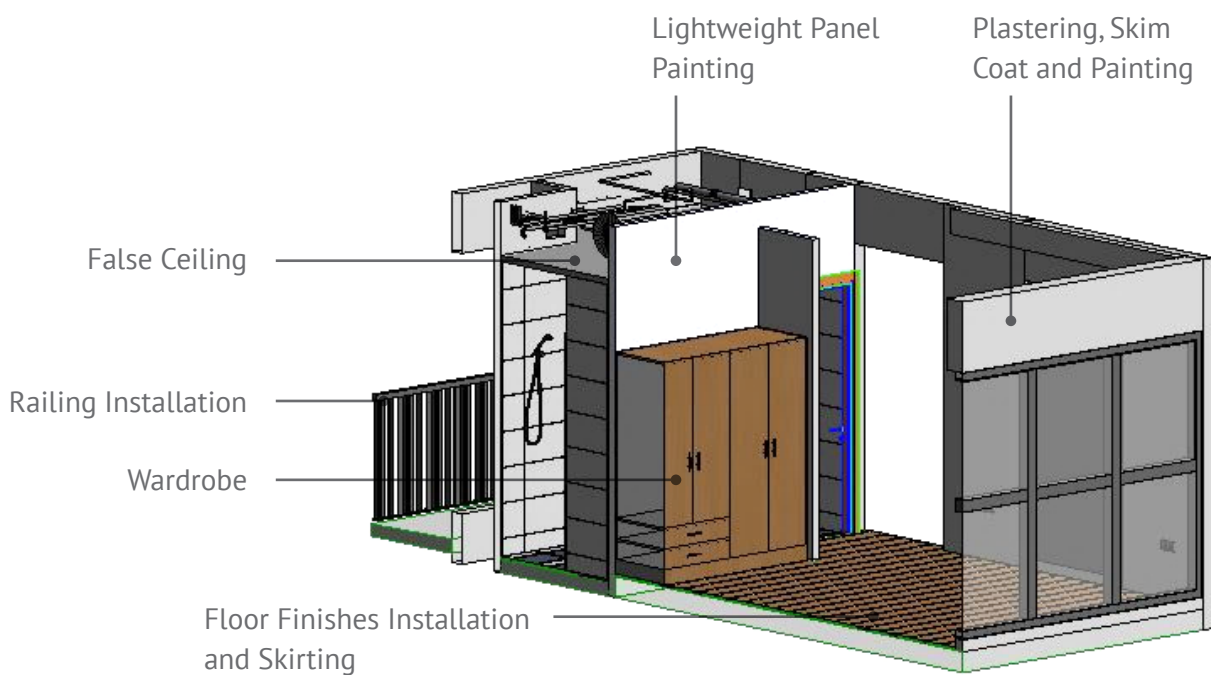
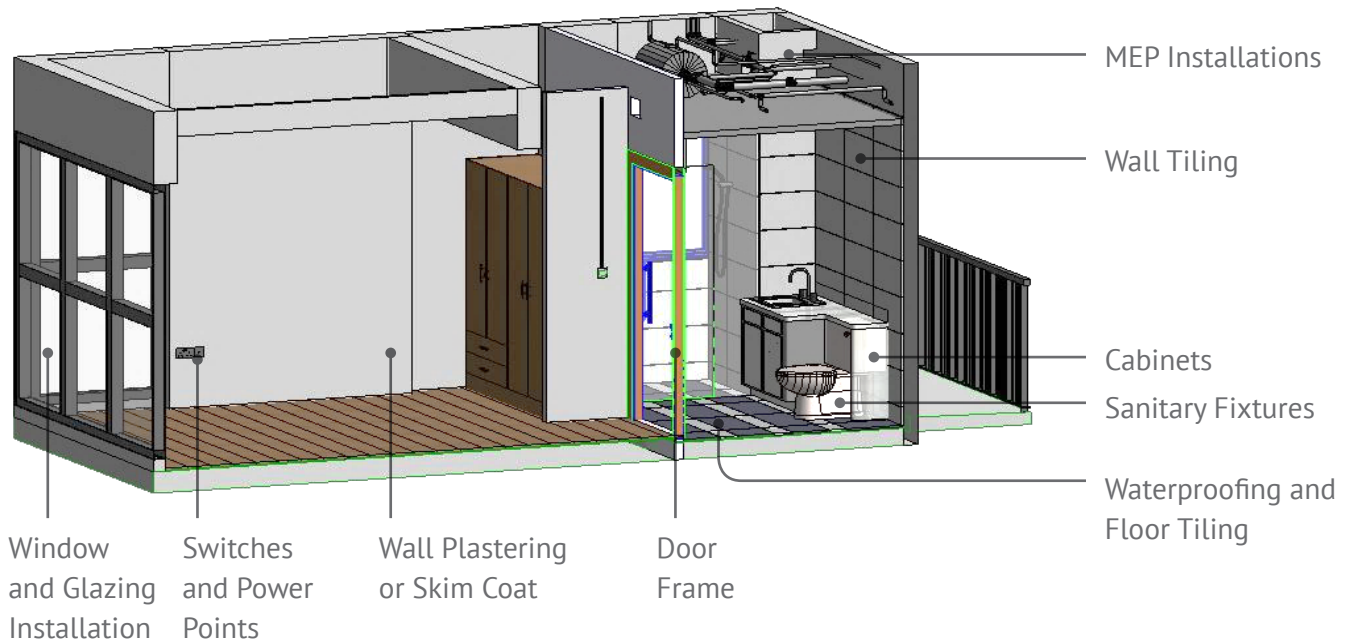

1

Levelling the module, and checking for alignment and dimensions



2

Installation of light weight panels



3

MEP installation

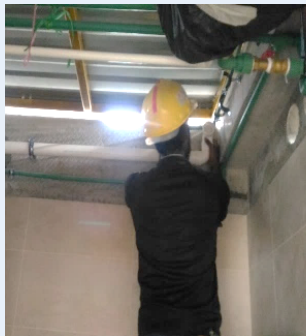

4

Testing of MEP installations

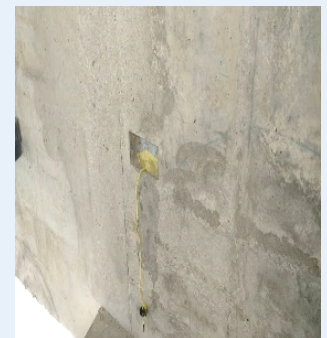
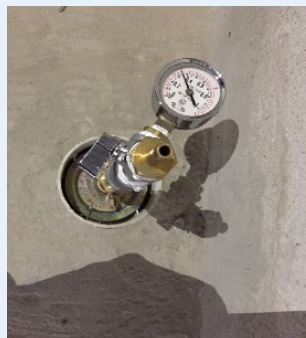

5

Structural Ponding test, waterproofing application and waterponding test

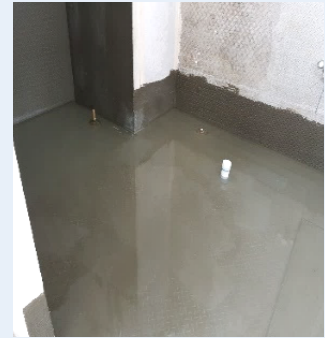

6

Floor screeding works



7

Fixing of window frame and glazing

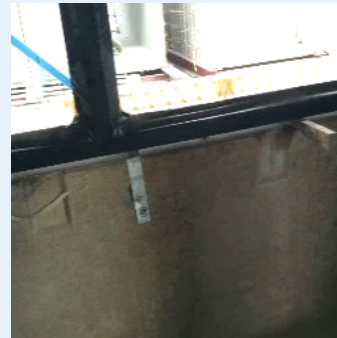

8

Installation of door frames

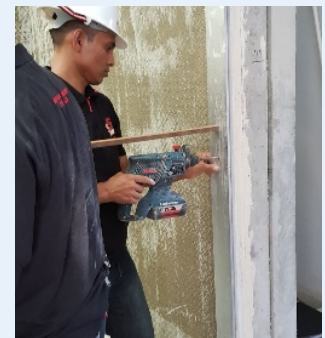

9

Wall tiles installation



10

Plastering and skim coating works



11

Floor finish installation

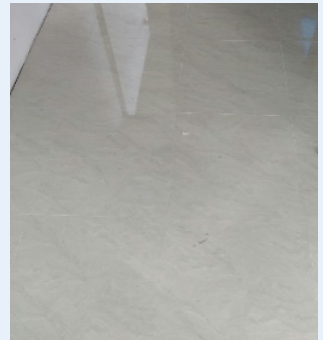

12

Floor finish installation

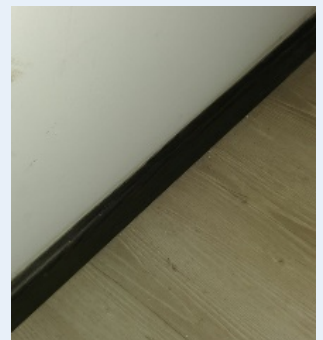
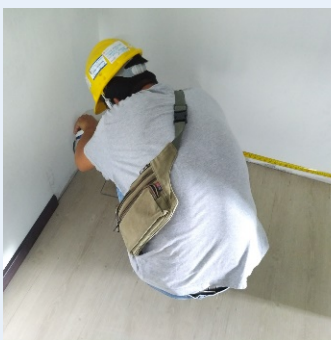

13

Installation of bathroom/sanitary fixtures

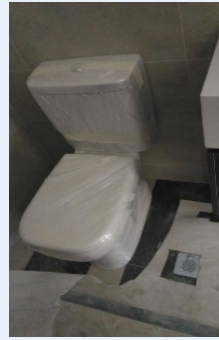
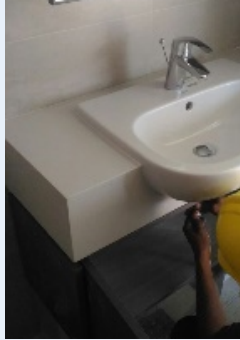

14

Installation of wardrobe



15

Installation of cabinets



16

Completion of MEP piping and accessories

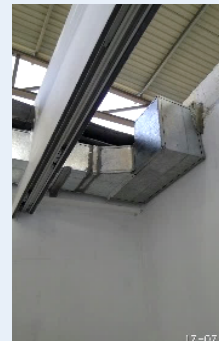
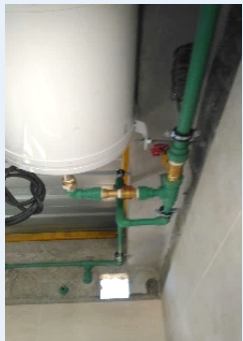

17

Installation of railing works



18

Installation of false ceiling

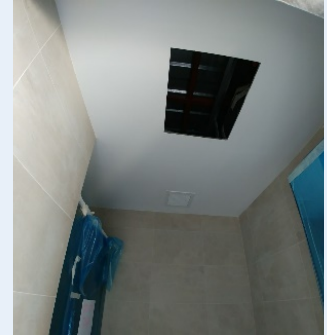

19

Painting works



20

Protection of the completed works



4.2 Steel PPVC Production

In order to ensure accuracy of the final product, special care must be given to each fabrication process, starting from design and fabrication of 2D and 3D jigs, procurement and preparation of structural steel member and the selection of the process, work sequence, method, machine and consumables used in the welding work.

Whenever possible, customised welding robots could be used in place of manual welding to reduce the reliance on manpower and to increase productivity.

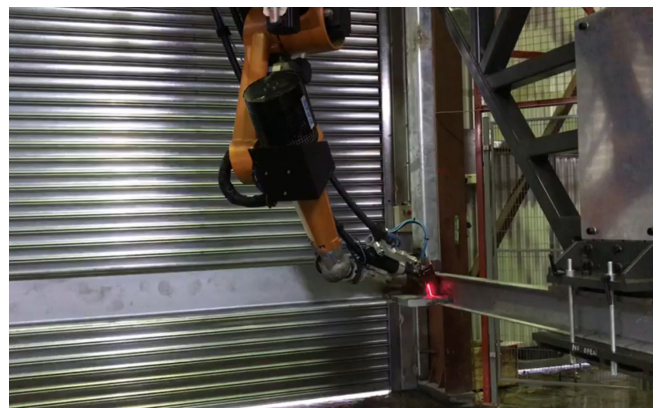

Figure: Robotic Welding Machine

Photographs Courtesy of Tiong Seng Contractors Pte Ltd and Steeltech Industries Pte Ltd

4.2.1 2D and 3D Jigs

The jigs used in the fabrication work are designed and fabricated to withstand additional force caused by heat transmitted between and within the steel sections to ensure the accuracy of the 2D frame and 3D shell remain unchanged during and after welding work.

The total number of jigs required for each project is determined by the design and type of modules, the fabrication schedule/rate and the flexibility of the jigs. It is different from project to project.

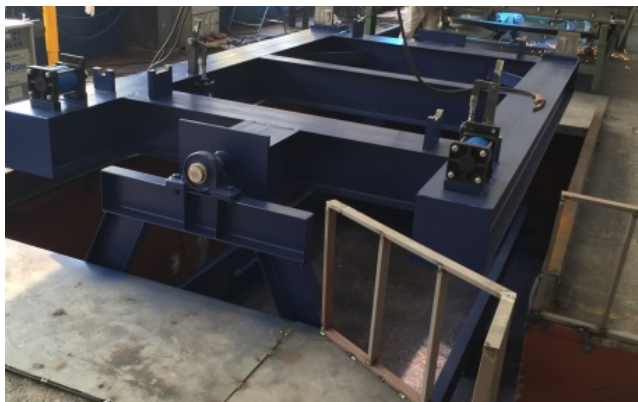

Photographs Courtesy of Moderna Homes Pte Ltd

4.2.2 Fabrication Process

1

Validation of raw material against Factory Production Certificate (FPC) and Mill Cert

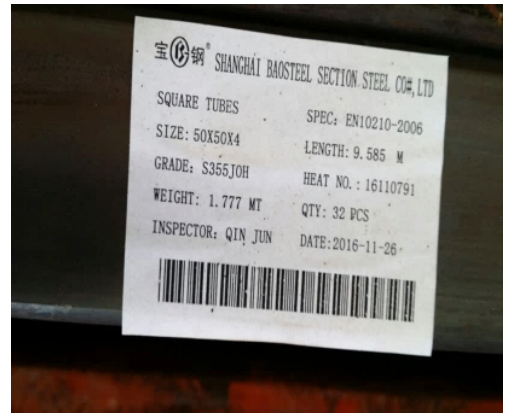

2

Preparation and cutting of material



3

Engraving for ease of identification and validating of galvanised thickness



4

Fitting and welding of steel members to 2D frame

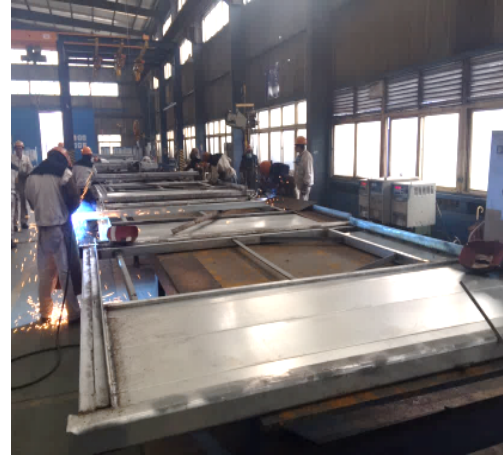

5

Fitting and welding of 2D frame into 3D shell



6

QC check on welding quality



7

Trial stack to ensure overall dimension and accuracy



8

Installation of M&E piping/conduit



9

Installation of drywall - studs, insulation, fireboard and/or plaster board



10

QC check - on drywall quality



11

Waterproofing and water ponding test

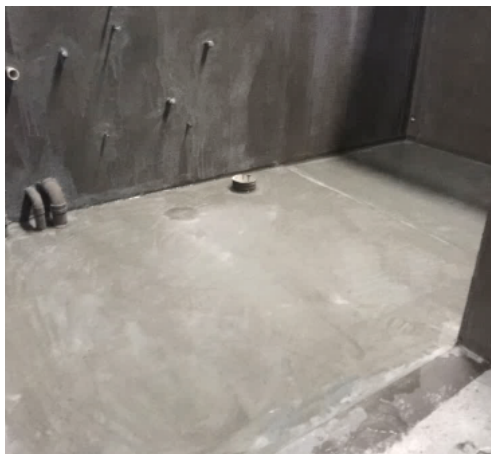

12

Tiling work - for floor and wall



13

QC check and tile protection



14

Installation of window frame, glazing and water tightness test



15

Installation of window grille and door frame

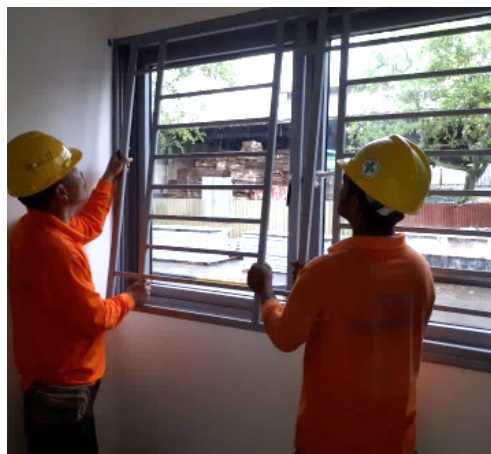

16

Installation of external cladding and ledge



17

Painting - basecoat, 1st coat and 2nd coat



18

Installation of wardrobe and fixing of plumbing/sanitary ware

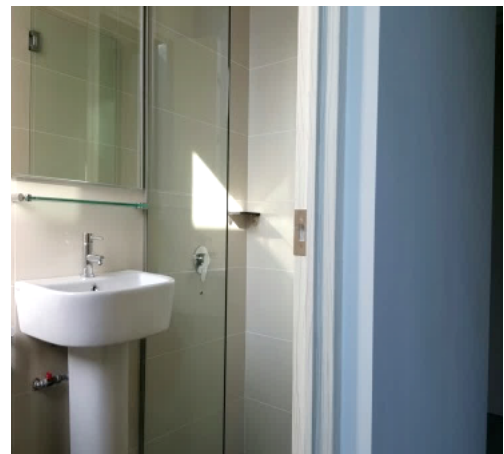

19

Protection of modules (from water ingress) before delivery



20

Delivery and installation of PPVC modules



21

Modules installed on site



Photographs Courtesy of Office of Development & Facilities Management, Nanyang Technological University



Photographs Courtesy of NorthernOne Development Pte Ltd and Surbana Jurong Pte Ltd

Protection, Transportation and Lifting

5.1 Transportation Plan

In order to ensure the quality of the PPVC modules, it is important to set up a comprehensive Transportation Plan to analyse and mitigate issues brought about during deliveries. This is to avoid potential damage to the module in long distance travel. The Transportation Plan shall comply with LTA's traffic regulatory requirements.



At the same time, Just-In-Time (JIT) delivery concept shall be studied with the transportation issues in order to ensure the following:

1. The right time of delivery,
2. Manage site storage,
3. Optimise crane usage,
4. Minimise the hoist and handling of PPVC

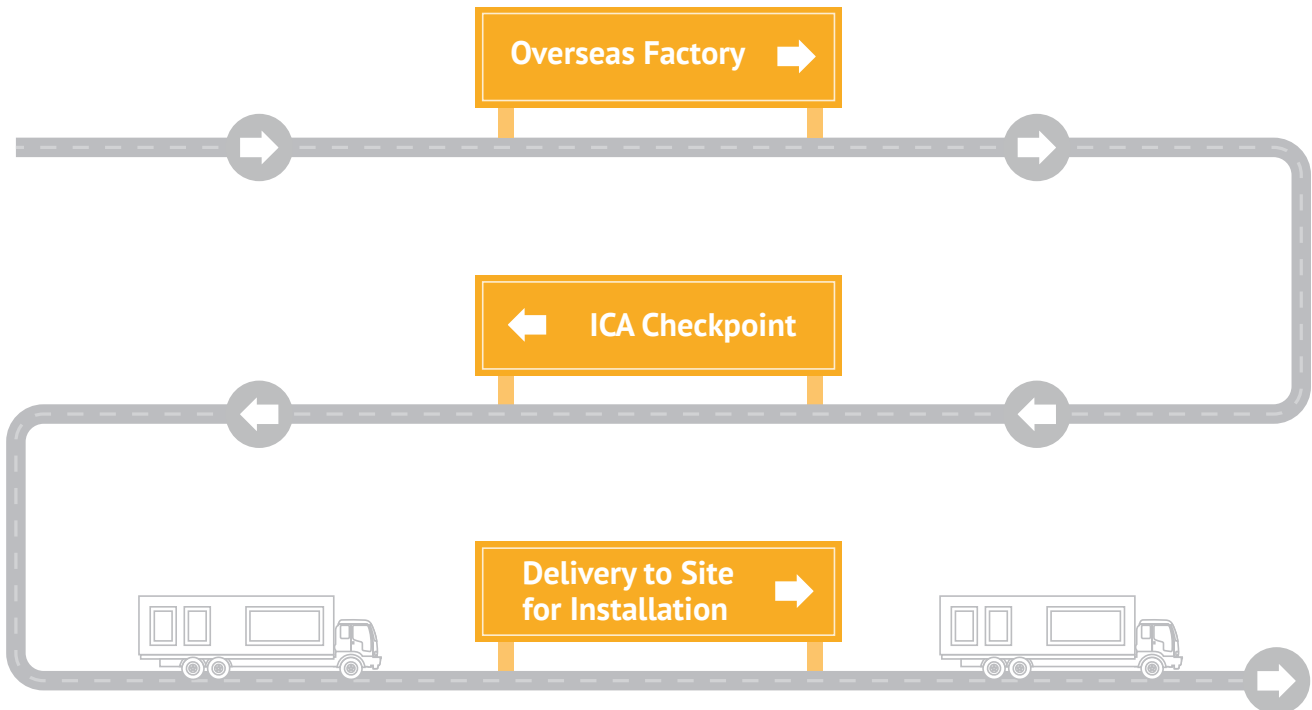

5.2 Packaging, Protection and Labelling

- Packaging of the finished PPVC product shall be controlled and inspected to ensure conformance with the specified and/or contracted requirements.
- The protection to completed PPVC modules shall be provided to the extent necessary to prevent potential damage, deformation or deterioration of the installed finishing components and/or to the structure while in transit or during unloading at project site. This includes the provision of appropriate protection sheet to internal finishes and to the external surface of structures.
- All finished PPVC modules shall have the manufacturer's label and installed for identification.

5.3 Module Cover (Temporary or Permanent)

- Module cover shall be manufactured according to size and design requirements (applicable to Reinforced Concrete PPVC).
- Temporary or permanent covering method depends on the project specification. An approval should be sought prior to installation.
- Installation of cover shall be inspected and approved prior to any handling for delivery.

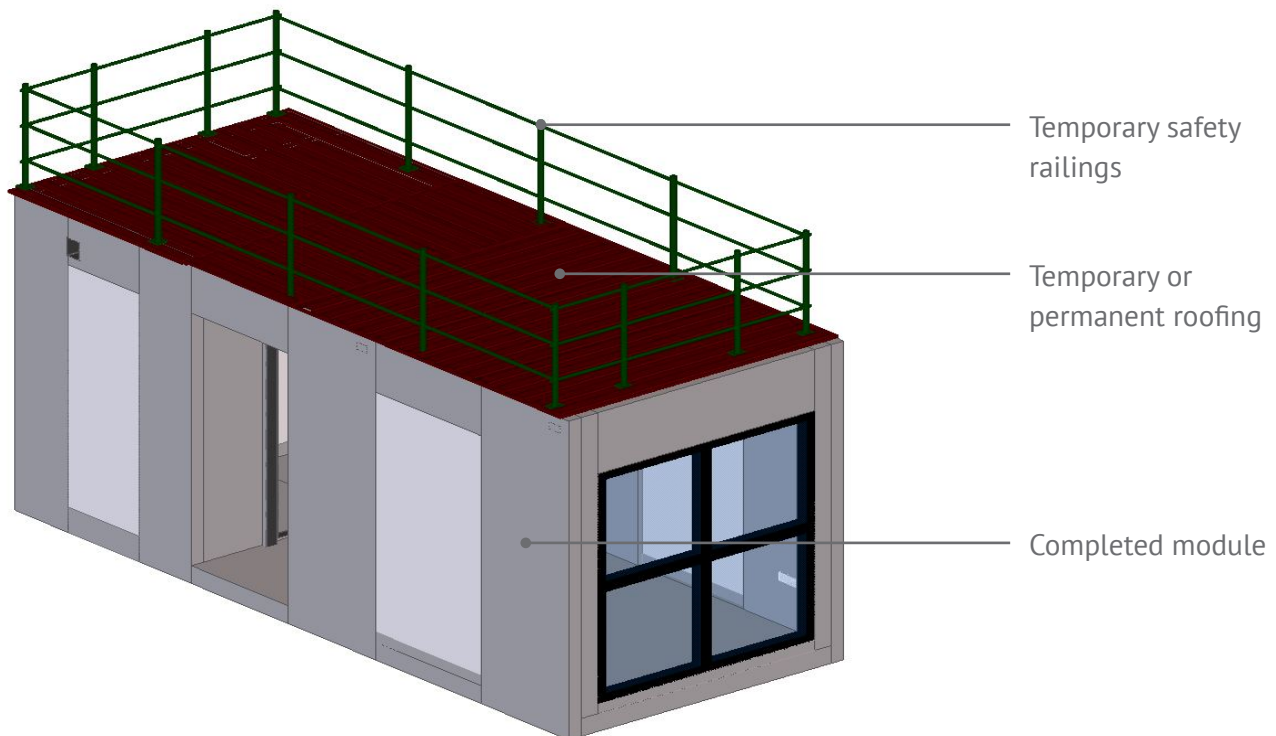

Construction and Project Management

6.1 Location of The Project and Adjacent Areas

- The condition of the roads surrounding the project must be able to accommodate the weight and size of the PPVC module delivery.

6.2 Access and Traffic Management for Trailers with Heavy Cargo

- The access to and within the site must be able to accommodate trailers with heavy cargo. Slopes and undulating terrain might prove to be a challenge for heavy vehicles. The turning radiuses of the trailers has to be considered during the planning stage of the site to avoid choking of vehicle access.
- Trailers with heavy cargo pose potential hazards upon entering while navigating the site. Traffic controller has to be employed to ensure smooth traffic management within the site.



6.3 Consideration of Just-In-Time (JIT) Operation

- Unlike conventional precast, PPVC modules are unable to be stored on site. Therefore, a Just in Time (JIT) installation could prove to be efficient and productive. The rate of installation has to be determined for a smoother JIT operation.
- Precast supplier can further employ systems such as Traffic Monitoring and GPS for Prime Movers to better facilitate deliveries. This will in turn make JIT operation smoother and more predictable.
- It is advisable to have space for unloading and storage in the event where JIT installation is not possible, e.g. during inclement weather, etc.



6.4 Types of Cranes

- The crane employed must be able to handle the weight of the PPVC modules, but at the same time be able to provide enough coverage for the intended block.
- Contractors shall seek approval from the relevant authorities on the maximum allowable AMSL clearance for erection of cranes.

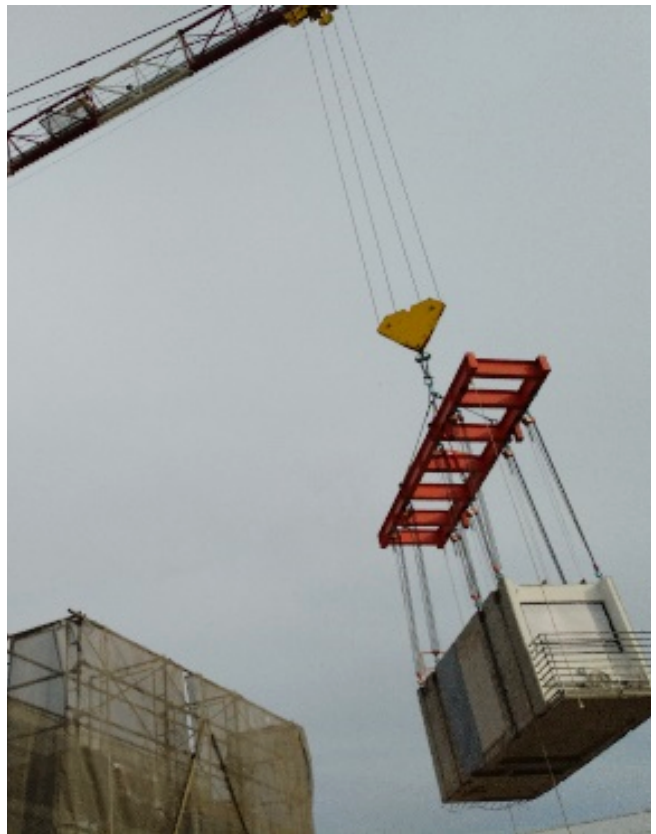

6.5 Safety



A comprehensive risk assessment shall be established to identify all potential hazards. Appropriate control measures must then be set up, communicated and implemented before the commencement of works.

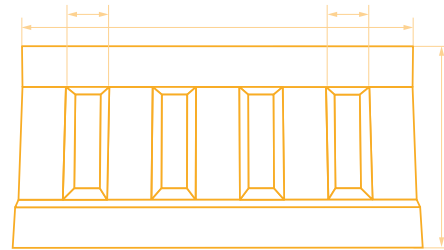

A comprehensive Fall Prevention Plan with Safe Work Procedure and appropriate control measures have to be established. Control measures such as safety barricades shall be provided for all open sides where a person may fall. Such barricades can only be removed during installation when the precast component is hoisted near its designated position.



All workers who are carrying out work at height shall be provided with the appropriate Personal Protective Equipment such as a personal fall arrest system. They shall be trained in the proper use of the system and ensure that the system is in place at all times.



All lifting gears and equipment are to be in serviceable condition. Checks have to be conducted by Accredited Checkers periodically to ensure workers are working with safe and functional equipment.

Installation

7.1 Access and Egress

- An access has to be provided for workers to move in and out during an installation. Any open area will have to be covered with safety barricade to prevent any worker from falling from height. A clearly demarcated egress has to be provided as well to allow workers to exit the work area in the case of an emergency.

7.2 Vertical and Horizontal Alignments

- Special attention has to be given to the alignments during installation. The method statement for installation should indicate clearly how proper alignments can be achieved to prevent any abortive works.
- Improper vertical and horizontal alignments cause external gaps which require additional touch-up work such as hacking and plastering. Windows and/or any external fixtures will look slanted as well.



Vertical Misalignment



Horizontal Misalignment

- MEP services including lightning protection system, sanitary and rain water discharge system etc. require proper vertical continuity connection. Installation of P-trap, S-trap if required, shall not impact finishes done up in a factory. If vertical concealed shaft is provided, space for installation works shall be allocated to facilitate vertical connection works.
- For MEP services that require installation works horizontally crossing modules, (including wiring, pressurized pipeworks, gradient pipeworks), the method of connection, if required, shall not compromise the level of continuity. All point of connections shall be properly secured by proper support. Method of connections shall not compromise the gradient required for gradient-pipeworks. Proper protection to finishes to be provided if hot work is required for connections. Installation works shall be done via the space allocated for installation works.

7.3 Sequencing of the Modules Installation

- It will be useful to work out the installation sequence of components to best maximise productivity during installation. E.g. it might be easier to install modules facing the external and work towards the inner modules.

7.4 Safety

- Workers are prone to high-risk activities such as Lifting Operation and Fall from Height. Proper safety equipments are be provided to ensure the well being of the workers are taken care of.
- Safety documents such as Risk Assessment and Safe Work Procedure are to be submitted and vetted thoroughly by the site safety officer. Safety Instruments are to be checked regularly. Daily Permit to work has to be submitted dutifully to ensure workers work in a safe environment.

Critical Inspection and Quality Check

8.1 Quality Checks

8.1.1 Reinforced Concrete PPVC

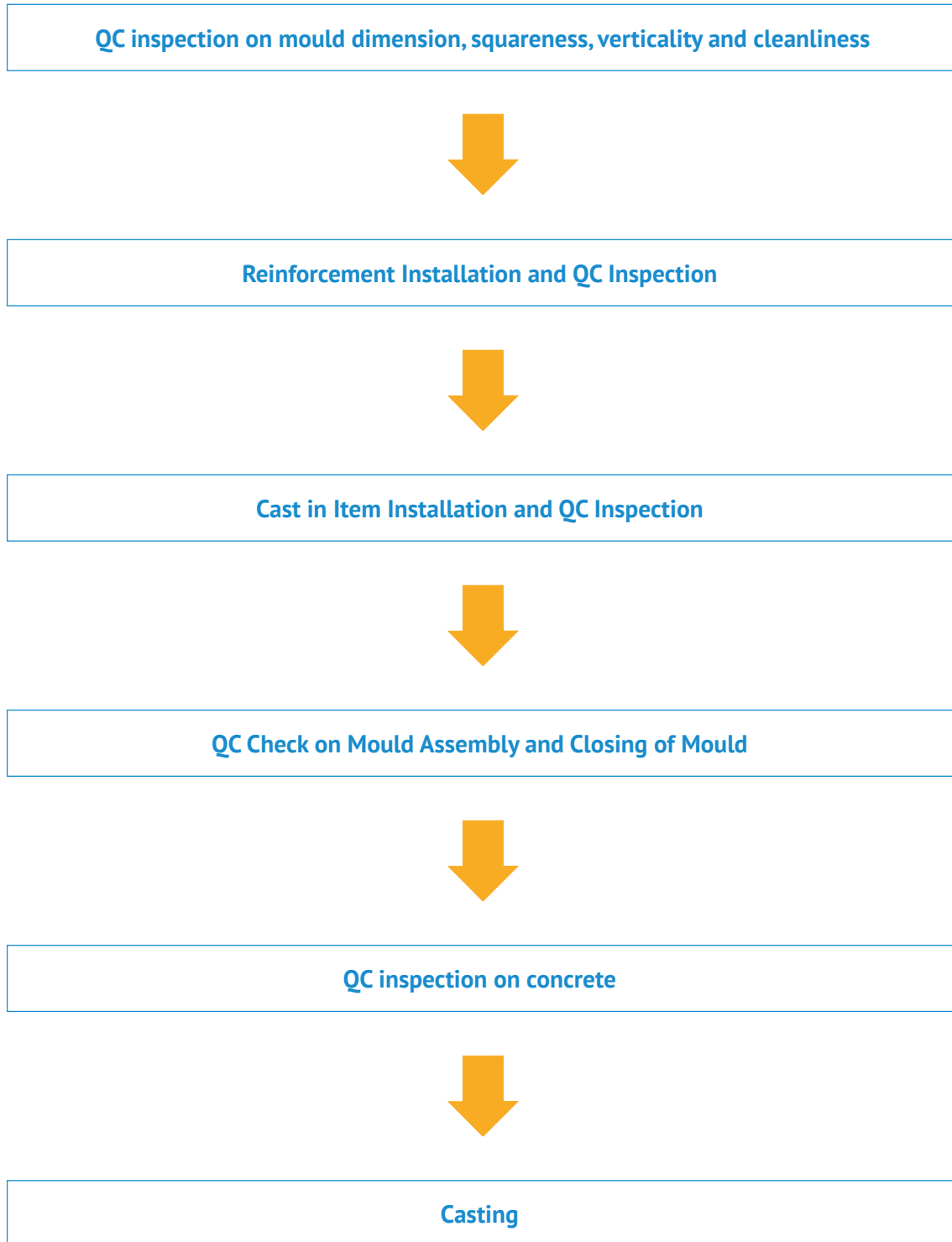

8.1.2 Steel PPVC

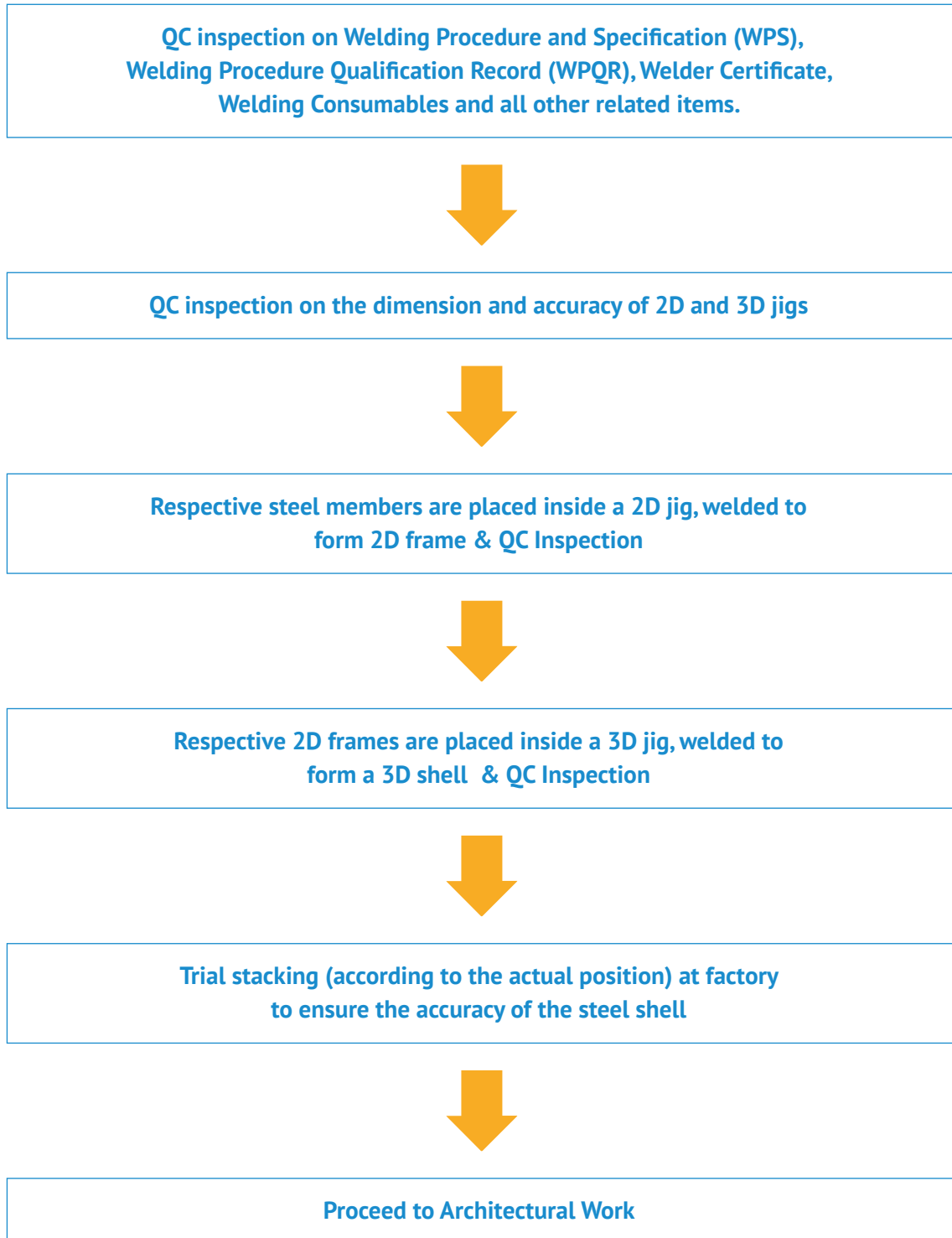

8.2 Structural Works

The modules shall be pre-assembled before proceeding with the following inspection and finishing works.

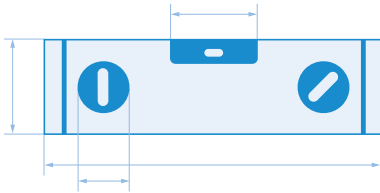

LEVEL AND ALIGNMENT

The level and alignment shall remain within the tolerance limits.

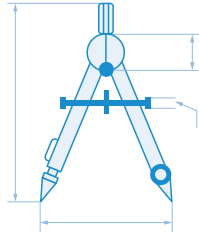

VERTICALITY

Finished module shall maintain its verticality not greater than the stipulated tolerance for PPVC.

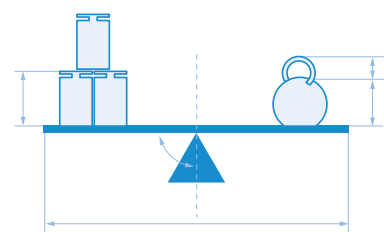

BULGING

No bulging of all structural elements, as this will decrease the stability of the structures.

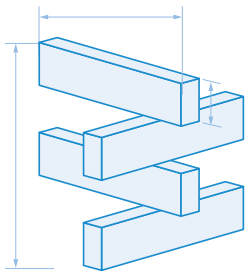

POSITION OF CONTINUITY

It is significant to maintain the position of reinforcement continuity to increase the speed of installation of precast module.

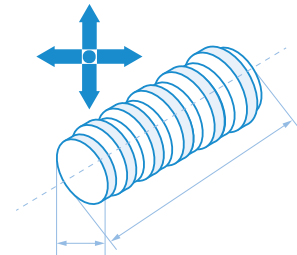

LOCATION OF CAST IN ITEMS

The location of the cast-in items shall be checked and verified prior to casting to avoid a redo/rectify.

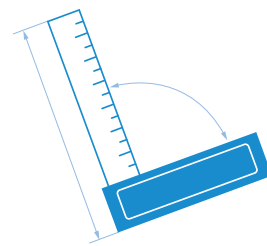

TWISTING OF MODULES

All precast modules shall not be greater than the allowable tolerance of all corners. This will apply to the installation with regards to level, alignment and verticality.



FIRE AND CORROSION PROTECTION

Passive fire protection layer and corrosion protection layer for all structure steel members must be checked and confirmed to ensure the compliance to the code.

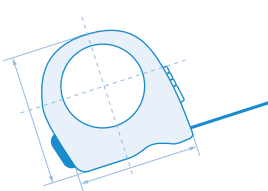

STRUCTURAL OPENING POSITION AND DIMENSION

This will not be less than the actual dimension of doors, windows and etc.

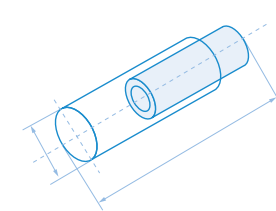

MEP OPENING

Shall be larger than the actual size of the pipes.

8.3 MEP Works

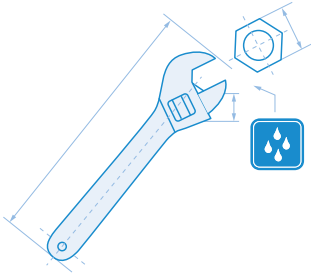

WATER TIGHTNESS TEST

To ensure that pipe works are water-tight before and after the architectural finishing works.

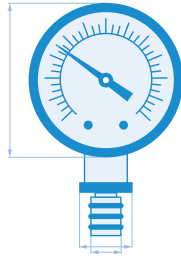

PRESSURE TEST

To ensure no leakage for pressurised pipe works.

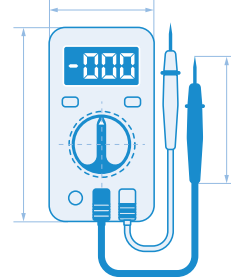

CABLE CONTINUITY TEST

Shall be carried out to ensure cable and wiring condition.

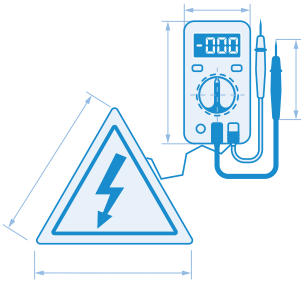

EARTHING MEGGER TEST

To be carried out after module is completed to check on the continuity of conductors for lightning protection.

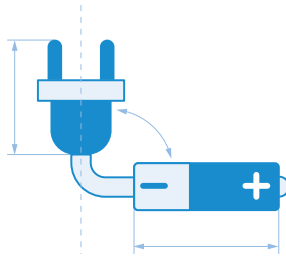

ELECTRICAL PHASE CHECK

Required to ensure load is distributed in accordance to design among phases.

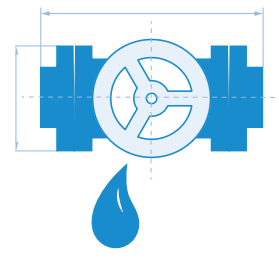

SHAFT LEAKAGE INSPECTION

To be carried out in conjunction with water-tightness test of vertical pipe shaft.

8.4 Architectural Works



Figure: Alignment verification.

VERTICAL AND HORIZONTAL ALIGNMENTS

Shall incorporate from the given 1 meter datum and offset line before finishing works.



Figure: Levelling of module

LEVELLING

To ensure that the module is levelled and set before the start of the finishing works.



Figure: Lightweight Panel Installation

LIGHTWEIGHT PANEL INSTALLATION AND QC CHECK

This will be installed as per the approved materials and shop drawing. Adhere to approved method statement to ensure that the execution falls within the acceptable tolerance.



Figure: Waterproofing Application

WATERPROOFING APPLICATION AND QC CHECK

Application of waterproofing shall be carried out by a qualified waterproofing installer. To adhere to approved materials and method statement to ensure that the waterproofing are installed accordingly.



Figure: Water Ponding Test

WATER PONDING TEST

Shall comply with the approved method statement.



Figure: QC Check on Tiling

TILING INSTALLATION AND QC CHECK

All materials and method statement as well as shop drawing shall be approved by the relevant consultant/s. It is important to check the batch delivery to control the tonality of the tile. Only a qualified tiler can install the tile.



Figure: Alignment verification.

PULL-OUT TEST

This will be carried out by an accredited laboratory.



Figure: Spray Test

SPRAY TEST

Shall comply with the approved method statement.

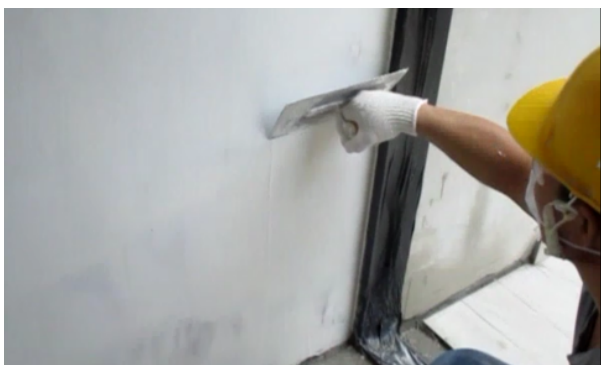

Figure Skim Coat Application

SKIM COATING APPLICATION AND QC CHECK

All materials as well as the method statement recommended by the manufacturer shall be approved.



Figure: Floor finishes Installation

FLOOR FINISHES QC CHECK

All materials and method statement and shop drawing shall be approved by the relevant consultant/s.

All materials and method statement shall be approved by the relevant consultant/s.



Figure: WC Installation

KITCHEN AND SANITARY WARE INSTALLATION AND QC CHECK

All materials, shop drawings and method statement shall be approved by the relevant consultant/s.



Figure: QC check on Window Installation

DOOR AND WINDOW INSTALLATION AND INSPECTION

All materials, method statements and shop drawings shall be approved by the relevant consultant/s.



Figure: Railing Installation

RAILING INSTALLATION AND INSPECTION

All materials, method statements and shop drawings shall be approved by the relevant consultant/s.



Figure: Painting Application

PAINTING APPLICATION AND INSPECTION

All materials and method statement shall be approved by the relevant consultant/s.

Maintenance, Replacement and Renovation

9.1 Maintenance and Renovation

It is essential to exercise care during renovation to prevent damage to the unit. The trained renovator engaged for the project should use the appropriate tools and follow the instructions in the homeowner user manual.

- The renovator should be trained.
- It is important to use appropriate tools for renovation works.
- Exercise due care when renovating, replacing tiles, etc. by referring to the homeowner user manual.



9.1.1 Homeowner User Manual

Besides engaging a trained renovation contractor, homeowners should have a ready reference of the PPVC system used in the unit. It is good practice for developers/builders to provide a homeowner user manual of the PPVC upon completion of the project. The homeowner and subsequent buyers of the unit should obtain a copy of the homeowner user manual after taking over the unit and follow the recommendations on maintenance and renovation to PPVC units provided in the manual.

The information in the homeowner user manual could include (but not limited to) the following:

GENERAL INFORMATION ON PPVC

- (i) Introduction to the PPVC installed
- (ii) Safety notices
- (iii) Instruction for use

STRUCTURE OF THE PPVC

- (i) Floor
- (ii) Wall
- (iii) Ceiling
- (iv) Water piping
- (v) Sanitary discharge pipe/vertical soil stack
- (vi) Electrical conduits

LAYOUT OF THE PPVC

- (i) General layout
- (ii) Waterproofing layout
- (iii) Locations of concealed services
- (iv) Location of access panel
- (v) Location of the manufacturer's label

CLEANING AND MAINTENANCE ADVICE

- (i) Internal fittings, tiles and accessories
- (ii) Floor trap
- (iii) Ceiling access panels

ALTERATION, REPAIR AND REPLACEMENT WORKS

- (i) Replacement of accessories/installation of additional fittings
- (ii) Availability and supply of spare parts
- (iii) Instructions for drilling and fixing
- (iv) Instructions for tile replacement
- (v) Instructions for grab bars installation

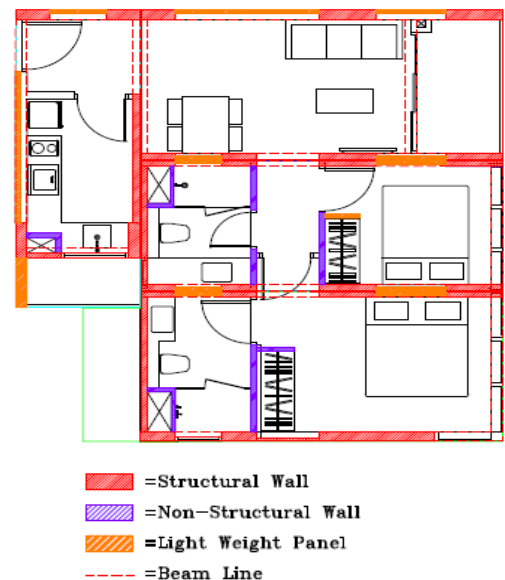

Figure: Example of unit floor plan

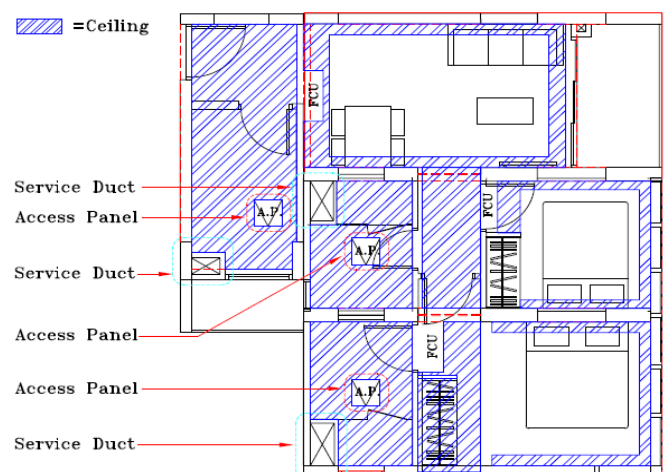

Figure: Example of reflected ceiling plan

Regulations

10.1 List of Regulators

| S/N | Agency | Regulation |
|-----|---------------------------------------|---|
| 1 | Building Construction Authority (BCA) | Code of Practice on Buildability 2017 |
| | | CP82, BCA's Good Industry Practice Guide |
| | | Technical Requirements for Storey Shelters 2015 |
| | | Technical Requirements for Household Shelters 2012 |
| 2 | Land Transport Authority (LTA) | Rule 99 of Road Traffic Rules (OVM) |
| | | Rule 2010 Promulgated under the Road Traffic Act (OVM) |
| 3 | Singapore Civil Defence Force (SCDF) | Fire Safety Act and Regulation "Code of Practice for Fire Safety Precaution in Buildings" |
| | | Fire Safety Requirements for the use of Plastic in Building Construction, SCDF's circular dated 1 Oct 2014. |
| | | Permitting Services within Fire-Rated Dry Construction in Buildings, SCDF's circular dated 13 Nov 2014. |
| 4 | National Environment Agency (NEA) | Code of Practice on Environmental Health, Singapore Standard SS593, COP on Pollution Control, Code of Practice on Sewerage and Sanitary Works, Environmental Protection and Management Act, and their Regulations, including the Environmental Protection and Management (Control of Noise at Construction Site) Regulation |
| 5 | Public Utilities Board (PUB) | Singapore Standard CP 48: Code of Practice for Water Services |
| | | <ol style="list-style-type: none"> 1. Sewerage and Drainage Act 2. Sewerage and Drainage (Sanitary Works) Regulations 3. Code of Practice on Sewerage and Sanitary Works 4. Code of Practice on Surface Water Drainage 5. Public Utilities (Water Supply) Regulations |
| 6 | Ministry of Manpower (MOM) | BS EN 1253-1, in event, if client preferences for shallow floor trap (SFT) all relevant test shall comply with BS EN 1253-1 as follows: |
| | | <ol style="list-style-type: none"> 1. Anti-Blockage Test 2. Water Tightness Test 3. Flow Rate Test 4. Resistance to water seal to pressure 5. Odour Tightness Test 6. Depth of water seal 7. Access for Cleaning 8. Side Inlet |
| 6 | Ministry of Manpower (MOM) | Workplace Safety And Health Act 2014 |
| | | WSH (Exemption) Order 2011 |
| | | Workplace Safety and Health (Design for Safety) Regulation 2015 |

10.2 Minimum Level of Off-Site Works for PPVC

| Elements | Minimum level of completion off-site |
|--|---|
| Floor finishes | 80% |
| Wall finishes | 100% |
| Painting | 100% base coat, only final coat is allowed on-site |
| Windows frames and glazing | 100% |
| Doors | 100%, only door leaves allowed for on-site installation |
| Wardrobes | 100%, only doors are allowed for on-site installation |
| Cabinets | 100%, only doors are allowed for on-site installation |
| MEP including water and sanitary pipes, electrical conduits and ducting | 100%, only equipment to allowed for on-site installation |
| Electrical sockets and light switches | 100%, only light fittings allowed for on-site installation |

**Source: Code Of Practice On Buildability , 2017 Edition*

10.3 Building Innovation Panel (BIP) and PPVC Manufacturer Accreditation Scheme (MAS)

To ensure quality and address potential downstream issues for local projects:

- PPVC suppliers are required to obtain In Principle Acceptance (IPA) from the Building Innovation Panel (BIP).
- The acceptance framework consists of two parts (1) Evaluation of the PPVC system by the BIP (2) Meeting the PPVC Manufacturer Accreditation Scheme (MAS) requirements.

PPVC Accreditation Programme

JOINTLY DEVELOPED BY



10.4 Singapore Standards, Codes of Practice and Good Industry Practice Guidebooks (References)

- CP 5: 1998 Code of Practice for Electrical Installations
- Code of Practice on Sewerage and Sanitary Works
- CP 48: 2005 Code of Practice for Water Services
- CP96: 2002 (2011) Code of Practice for Curtain Walls
- Code of Practice on Buildability 2017
- SS 608: 2015 Code of Practice for Gas Installation
- SS 555: 2010 Protection Against Lightning
- SS 553: 2009 Code of Practice for Air-conditioning and Mechanical Ventilation in Buildings
- SS 554: 2009 Code of Practice for Indoor Air Quality for Air-conditioned Buildings
- SS 212: 2007 Specification for Aluminium Alloy Windows
- SS 381: 1996 (2007) Materials and Performance Tests for Aluminium Curtain Walls
- EN1253-1 (shallow floor trap)
- In-built Bathrooms Performance Requirements
- Good Industry Practices Guide Book: Ceramic Tiling
- Good Industry Practices Guide Book: Marble and Granite Finishes
- Good Industry Practices Guide Book: Waterproofing for Internal Wet Areas
- Good Industry Practices Guide Book: Painting
- Good Industry Practices Guide Book: Timber Flooring
- Good Industry Practices Guide Book: Waterproofing for External Wall
- Good Industry Practices Guide Book: Aluminium Window
- Good Industry Practices Guide Book: Timber Doors
- Good Industry Practices Guide Book: Wardrobes and Kitchen Cabinets
- Good Industry Practices Guide Book: Precast Concrete Elements
- Good Industry Practices Guide Book: Drywall Internal Partition
- Good Industry Practices Guide Book: Design and Materials Selection (Vol 1)
- Good Industry Practices Guide Book: Design and Materials Selection (Vol 2)
- Design for Maintainability Checklist by BCA

10.5 Design for Safety

- PPVC supplier, designer, Qualified Person, Developer and Main Contractor are relevant stakeholders that shall be involved in the DfS review.
- Design for safety reviews should be carried out upstream, e.g. during the BIP application or at the concept and detailed design phases, to address risks that would manifest itself during:
 1. the construction stage,
 2. the building maintenance stage; and
 3. the demolition phase.

Things to note:

- For onsite installation, please pay special attention to activities related to Lifting, Access/Egress and Working at Height.
- The design should cater adequate provisions for safe PPVC building maintenance and repair.
- User/ installer manual should include safe demolition sequences and special precautions.
- PPVC suppliers/ designers shall control the design risks based on the Hierarchy of Control Measures. PPE shall be adopted as a last resort.



WSHC DfS Guidelines



WSH DfS Regulations

Specific requirements related to the PPVC should be considered in the early design review stage.

10.5.1 Access/Egress

As part of the design review, the entire process of which the PPVC units are to be installed should be reviewed. This should include how workers would gain access to and egress:

1. from the ground to the top of the modules loaded on a trailer;
2. from the ground to the top of the modules in the holding/ storage area;
3. from the working level to the top of a PPVC module that had just been installed;
4. from point A to point B of the same level of the installed PPVCs, or cast in-situ areas or working platforms.
5. from point A to point B of the different level of the installed PPVCs, or cast in-situ areas or working platforms.

Such access provisions include the use of MEWP, mobile tower scaffolds with appropriate height, fixed ladders with proper fixtures that are cast-in during the fabrication of the modules or use of permanent/temporary staircase. If a vertical access ladder (see figure 2) is proposed, it should be secured in place at its top & bottom and extended 1 meter above the landing. Such ladder will not be suitable if the user is unable to maintain 3-points of contact. In general, a step platform ladder (see figure 3) would provide a safer access and more stable work surface than the vertical access ladder or A-frame ladder. If the ladder leads to a barricaded area, a proper access point should be catered for in the design.

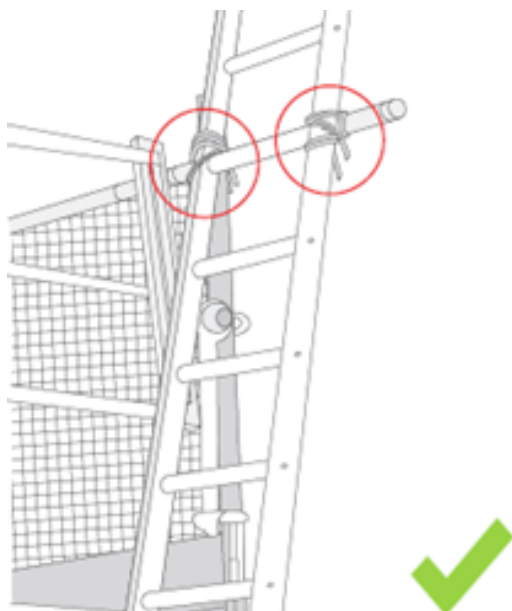

(Fig. 2) vertical access ladder with both stiles tied.



(Fig. 3) Step platform ladder (Mobile).

10.5.2 Choice Between Fall Prevention, Fall Restraint and Fall Arrest System

Before choosing a fall prevention or protection system, one should first consider elimination of working at height.

ELIMINATION OF WORK AT HEIGHT

Always explore elimination first. Works that involved a risk of fall should be eliminated at design stage. An example of PPVC risk elimination is shown below (e.g. A):

Example A: In the above figure, the designer had proposed connection of the two high floor modules using bolts, nuts and a link plate. As the connection work can only be carried out externally from the building façade, it would mean that workers will have to extend their bodies out of the PPVC to reach the connections thereby exposing themselves to a risk of fall. After the review, the designer redesigned the connections to be connected within the safety of the PPVC unit and successfully eliminated the falling from height risk related to the task entirely.

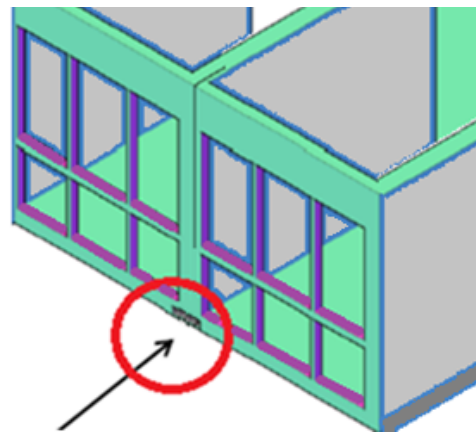

SUBSTITUTION OF A SAFER WORK-AT-HEIGHT METHOD

- If the risks cannot be eliminated by design, designers should explore safer work methods to minimise the risk e.g. use of MEWP, scaffold or step platform ladder instead of A-frame ladder placed beside the PPVC.

ENGINEERING CONTROL – FALL PREVENTION

- Where workers are required to work on the top of a module or at any location where there is risk of fall, the open sides of the module or location should be effectively barricaded or guarded (Engineering Control measure). The connections for the barricades or guardrails should be built-in with the module where possible.
- Fall prevention system such as the use of barricades is preferred over fall restraint and fall arrest systems. Barricades provide a high degree of protection once properly installed. When a barricade is proposed, the design should meet the requirements under the Approved Code of Practice for Working Safely at Heights published by WSHC. (See link below)



ACOP Working Safely at Heights

PERSONAL PROTECTION EQUIPMENT (PPE)

Where barricades or guardrails cannot be provided, anchorage points and/or lifelines should be provided to ensure that workers are protected from falling from height. Anchorage points, anchorage lines, safety harness etc. should be pre-planned for, taking into consideration the zone of which the workers would need to operate for rigging / unrigging operations and for other works, e.g. grouting works at the top of the module or at working level.

In general, there are two types of fall protection or prevention systems: Fall Restraint and Fall Arrest, of which the former is preferred over the latter.

Fall Restraint Systems prevent a person from falling and includes the use of:

- i) Work-Positioning and
- ii) Travel Restraint systems

Fall Arrest Systems protect a person after the person falls a certain distance by stopping the fall before the person hit the surface below. It includes the use of:

- i) Full body harness, shock absorber and Anchor
- ii) Safety nets

Please also refer to the prevailing codes including SS 570, S541 and SS607.

10.5.3 Module Installation and Alignment

During the PPVC installation, it is important to avoid the need to align too many connecting bars as this will increase the installation duration and the likelihood of installers being exposed to risks of crushing and being caught-in-between objects. In the event of misalignment/ bent bars, there should be established measures to ensure no worker shall go underneath the PPVC unit to realign the bars.

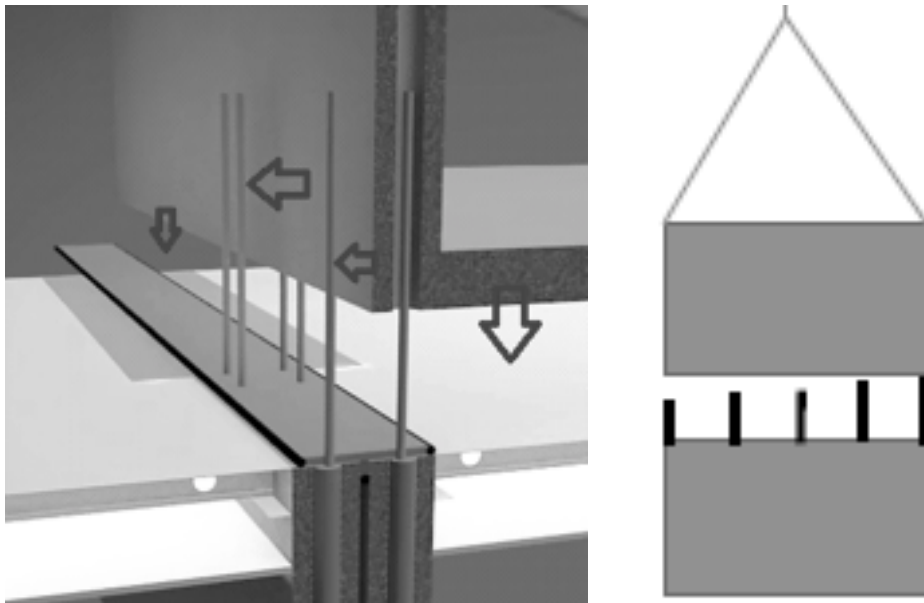

10.5.4 Useful Resources



WSH Council's Website



MOM's Website



WSHC-Approved COP



WSH Act and Regulations

Appendix

Some PPVC Project References in Singapore (Completed and Ongoing)

A. Completed PPVC Project



1. NANYANG CRESCENT HOSTEL

- 4 blocks, 11 to 13 storeys
- Hostel rooms are built using PPVC

PPVC System

- 784 modules
- Steel PPVC frame with cement board floor base

Photographs Courtesy of Office of Development & Facilities Management, Nanyang Technological University for Nanyang Crescent & SAA Architects Pte Ltd



2. WOODLANDS NURSING HOME

- 9 storeys

PPVC System

- 343 modules
- Steel PPVC system with concrete floor base

Photograph Courtesy of Dragages (Singapore) Pte Ltd



3. NTU NORTH HILL HOSTEL

- 8 blocks, 13 storeys
- 1,580 hostel rooms, 66 apartments

PPVC System

- 1,200 modules
- Steel PPVC frame
- Cement board floor for hostel rooms
- Lightweight concrete floor for staff apartments

Photographs Courtesy of Office of Development and Facilities Management, Nanyang Technological University for Nanyang Crescent



4. CROWNE PLAZA HOTEL EXTENSION

- 10-storey hotel project with creative facade design
- Single block
- 243 guest rooms

PPVC System

- 252 modules
- Steel PPVC with concrete floor base

Photographs Courtesy of OUE Limited

B. On-going (under construction) Projects



1. BROWNSTONE EXECUTIVE CONDOMINIUM AT CANBERRA DRIVE

- 8 blocks, 10 & 12 storeys
- 638 residential units

PPVC System

- 4,436 concrete volumetric modules
- Concrete PPVC

Photographs Courtesy of Canvey Developments Pte Ltd (a subsidiary of City Developments Limited) and TID Pte Ltd



2. WISTERIA AT YISHUN AVENUE 4 – COMMERCIAL AND CONDOMINIUM DEVELOPMENT

- 3 blocks of 12-storey mixed development
- First 3 floors are commercial and the rest are apartment units
- A total of 216 apartment units

PPVC System

- 756 modules
- Steel PPVC frame with concrete floor base

Photographs Courtesy of NorthernOne Development Pte Ltd and Surbana Jurong Pte Ltd



3. CLEMENT CANOPY CONDOMINIUM AT CLEMENTI AVE 1

- 40-storey flat condominium development
- 505 apartment units

PPVC System

- 1,866 modules
- Concrete PPVC system

Photographs Courtesy of Site, Credit to Dragages (Singapore) Pte Ltd, Artist Impression to UOL Group Limited