



GM RB: 2016

BCA GREEN MARK FOR RESIDENTIAL BUILDINGS

Technical Guide and Requirements

Copyright

Copyright© 2017 by Building and Construction Authority.

All rights reserved. The Green Mark Criteria may be used by individuals for reference purposes only. Any user of the Green Mark Criteria shall retain all copyright and other proprietary notices contained in it. Any sale, modification, reproduction, display or distribution of the Green Mark Criteria or any copies thereof is not allowed without BCA's prior written consent, which may be obtained by writing to the following address or via email to bca_enquiry@bca.gov.sg.

Green Mark Department
Building and Construction Authority
52 Jurong Gateway Road
#11-01, Singapore 608550
(Above JEM)

Green Mark RB: 2016 Revision Log

Revision	Description	Date Effective
R0	Launch for Pilot	06/09/2016
R1	Revised Version for Implementation	22/09/2017
R2	Reformatting, minor wording and examples amendments	15/02/2020

CONTENTS

Assessment Framework	4
GM RB: 2016 Pre-Requisites	6
GM RB: 2016 Criteria	10
Design Stage and Verification Requirements	33

1.Climatic Responsive Design

P.1	Greenery Provision	35
P.2	Residential Envelope and Roof Thermal Transfer	36
P.3	Ventilation Performance.....	37
P.4	Air Tightness and Leakage.....	39
1.1	Leadership	40
1.2	Urban Harmony	48
1.3	Tropicality	59

2.Building Energy Performance

P.5	Vertical Transportation Efficiency.....	76
P.6	Air Conditioning System Efficiency	77
P.7	Lighting Efficiency	78
P.8	Renewable Energy Feasibility Study.....	79
2.1	Energy Efficiency	80
2.2	Energy Effectiveness	90
2.3	Renewable Energy	94

3.Resource Stewardship

P.9	Water Fitting for Common Facilities	101
P.10	Sustainable Construction	103
P.11	Embodied Energy	103
P.12	Sustainable Products.....	104
3.1	Water	105
3.2	Materials	112
3.3	Waste	136

4.Smart and Healthy Building

P.13	Low VOC Paints	141
4.1	Indoor Air Quality.....	142
4.2	Spatial Quality.....	148
4.3	Smart Building Operations	159

5. Advanced Green Efforts

5.1	Enhanced Performance.....	164
5.2	Demonstrating Cost Effective Design.....	164
5.3	Complementary Certifications	164
5.4	Social Benefits.....	165
	Annex A: Computational Fluid Dynamics Simulation Methodology and Requirements	166
	Annex B: Guidelines on Pre-Simulated Daylight Autonomy Tables and Daylighting Simulation Methodology.....	182
	References	199
	Acknowledgements	201

Assessment Framework

Assessment Process

The BCA Green Mark Certification Process is as follows:

Application

- Submittal of application with relevant supporting documents for certification upon finalisation of building design.
- Upon acceptance of application and fee payable, a BCA Green Mark Assessor will be assigned for the duration of the project.

Assessment

- To be conducted when design and documentary evidences are ready.
- Comprises design and documentary reviews to verify if the building project meets the intents of the criteria and certification level; as well as the prerequisite requirements.
- For projects with potential BCA Green Mark Platinum rating, a presentation to BCA panel for evaluation is required.

Verification

- To be conducted upon project completion.
- Includes review of delivery records, updated documents on green features and building energy performance data. Site inspection and measurement will be conducted.

Green Mark RB: 2016 Ratings

The environmental performance of a building development shall be determined by the numerical scores (i.e. Green Mark points) achieved in accordance with the applicable criteria using the scoring methodology and the prerequisite requirements on the level of building performance as specified in this Green Mark scheme document. Under this assessment framework, points are awarded for incorporating sustainable design features and practices, which would add up to a final Green Mark Score. Depending on the level of building performance and Green Mark Score, the building development will be eligible for certification under one of the ratings namely BCA Green Mark Gold, Gold^{PLUS} or Platinum. The design of the building development shall also meet all the relevant mandatory requirements regulated under the Building Control Regulations.

The Green Mark Score of the building design is the total of all the numerical scores (i.e. Green Mark points) assigned based on the degree of compliance with the applicable criteria. The following table states the corresponding Green Mark Score to attain the respective Green Mark rating namely BCA Green Mark Gold, Gold^{PLUS} and Platinum. Buildings must also fulfil their respective pre-requisite requirements to attain the respective Green Mark rating. The total points scored include the bonus points scored under Advanced Green Efforts.

GM RB: 2016 Points Summary

S/N	Item	Points
1. Climatic Responsive Design		35
1.1	Leadership	8
1.1a	Climatic and Contextually Responsive Brief	1
1.1b	Integrative Design Process	2
1.1c	Environmental Credentials of Project Team	2
1.1d	Building Information Modelling	2
1.1e	User Engagement	1
1.2	Urban Harmony	10
1.2a	Sustainable Urbanism	5
1.2b	Integrated Landscape and Waterscape	5
1.3	Tropicality	17
1.3a	Tropical Façade Performance	5
1.3b	Internal Organisation	2
1.3c	Ventilation Performance	10
2. Building Energy Performance		25
2.1	Energy Efficiency	12
2.1a	Air Conditioning System Efficiency	6
2.1b	Lighting Efficiency	4
2.1c	Car Park Energy	2
2.2	Energy Effectiveness	5
2.2a	Energy Efficient Practices, Design and Features	5
2.3	Renewable Energy	8
2.3a	Feasibility Study	0.5
2.3b	Solar Ready Roof	1.5
2.3c	Replacement Energy	6
3. Resource Stewardship		35
3.1	Water	13
3.1a	Water Efficiency Measures	9
3.1b	Water Usage Monitoring	1
3.1c	Alternative Water Sources	3
3.2	Materials	18
3.2a	Sustainable Construction	8
3.2b	Embodied Energy	2
3.2c	Sustainable Products	8
3.3	Waste	4
3.3a	Environmental Construction Management Plan	1
3.3b	Operational Waste Management	3
4. Smart and Healthy Building		25
4.1	Indoor Air Quality	8
4.1a	Occupant Comfort	2
4.1b	Contaminants	6
4.2	Spatial Quality	9
4.2a	Lighting	5
4.2b	Acoustics	2
4.2c	Wellbeing	2
4.3	Smart Building Operations	8
4.3a	Energy Monitoring	2
4.3b	Demand Control	2
4.3c	Integration and Analytics	2
4.3d	System Handover and Documentation	2
5. Advanced Green Efforts		20
5.1	Enhanced Performance	15
5.2	Demonstrating Cost Effective Design	2
5.3	Complementary Certifications	1
5.4	Social Benefits	2

BCA Green Mark Award Rating Scores

Green Mark Rating	Green Mark Score
Green Mark Platinum	70 and above
Green Mark Gold ^{PLUS}	60 to <70
Green Mark Gold	>50 to <60

Green Mark RB: 2016 Prerequisites

Prerequisite Requirements

Climatic Responsive Design

P.1 To enhance biodiversity through the integration of lush greenery provision, preservation of existing trees and sustainable landscape management. In addition, to reduce storm surges and improve quality of water entering the public drains through introduction of waterscape within the development. Projects are given two options to comply with:

Option 1: Minimum Green Plot Ratio (GnPR)

- Gold^{PLUS}: ≥ 4.0
- Platinum: ≥ 4.0 *OR*

Option 2: Minimum points scored under Part 1.2b Integrated Landscape and Waterscape

- Gold^{PLUS}: 2.5 points
- Platinum: 2.5 points

P.2 The residential envelope thermal transmittance value (RETV) of the building, as determined in accordance with the formula set out in the "Code on Envelope Thermal Performance for Buildings" issued by the Commissioner of Building Control, shall not exceed the following:

Level of Award	RETV
Gold	25W/m ² or lower
Gold ^{PLUS}	22W/m ² or lower
Platinum	20W/m ² or lower

The RETV of west, south-west and north-west facades of all buildings within development should not exceed maximum RETV of 25W/m².

The average thermal transmittance (U-value) for the gross area of the building's roof shall not exceed the following limits:

Roof Weight Group	Weight Range (kg/m ²)	Maximum U-value (W/m ² K)
Light	< 50	0.8
Medium	50 to 230	1.1
Heavy	> 230	1.5

P.3 To be eligible for Green Mark Platinum rating, it is a requirement to use ventilation simulation modelling and analysis or wind tunnel testing to identify the most effective building design and layout. The simulation results and the recommendations derived are to be implemented to ensure good natural ventilation. Projects are given the following pathway to comply with the requirement:

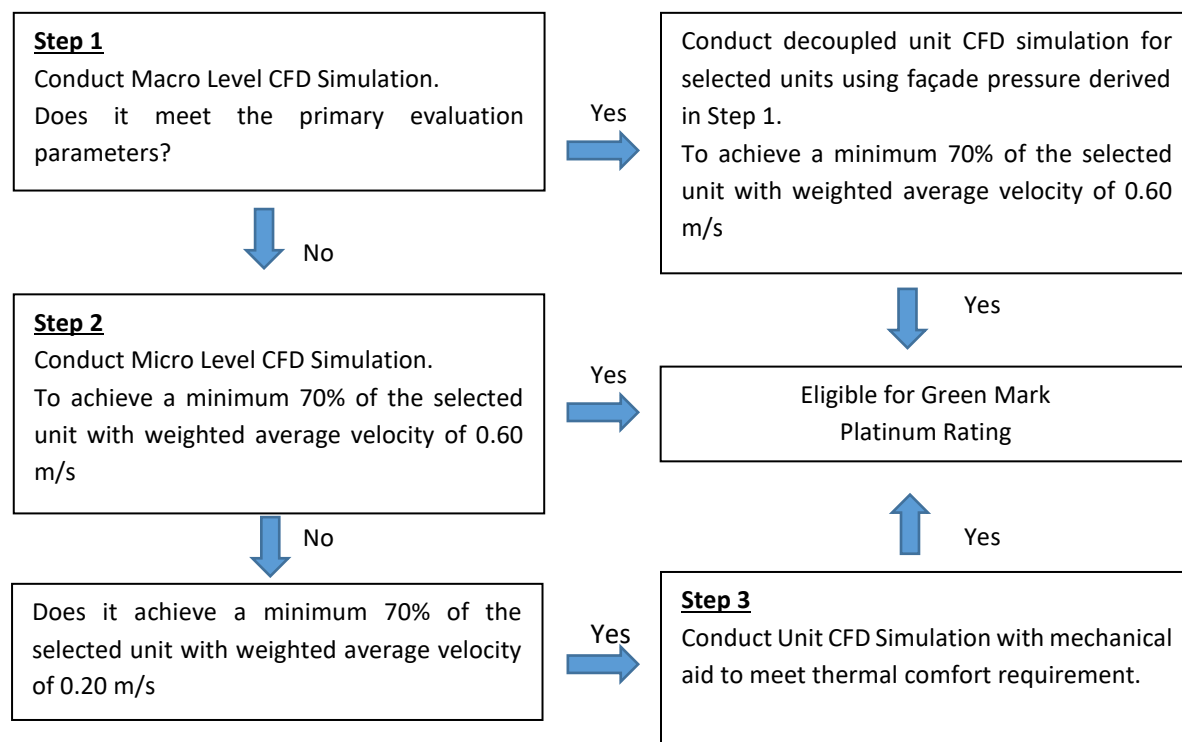

Other than dwelling units, common areas like staircases and lobbies (excluding those that are located in basement areas) should also be designed to be naturally ventilated (i.e. to provide openable windows or other openings with aggregate area of not less than 5% of the space required to be ventilated).

P.4 For windows and curtain wall systems, air leakage rates shall not exceed the limit specified in SS212 and SS381 respectively

Building Energy Performance

P.5 To adopt energy efficient vertical transportation systems to reduce their energy consumption.

All lifts to be equipped with Variable Voltage Variable Frequency (VVVF) drives and sleep mode features except for building typologies where such technology is not available.

P.6 Prescribed energy performance standard of air-conditioning system for all dwelling units to be as follows:

Level of Award	Air Conditioners with
Gold	$COP_{100\%} \geq 3.78$ and weighted $COP \geq 4.29$
Gold^{PLUS}	$COP_{100\%} \geq 4.86$ and weighted $COP \geq 5.50$
Platinum	

P.7 At least 10% improvement in lighting power budget over baseline (excluding external lighting).

Baseline = Maximum lighting power budget stated in SS530

P.8 To evaluate building footprint's potential in harnessing solar energy, so as to raise awareness of viable solar opportunities within the development and encourage building developers to adopt photovoltaics.

Minimum scores under 2.3a Renewable Energy Feasibility Study
(for buildings with footprint area¹ ≥ 1,000 m²)

Green Mark Gold: 0.5 points

Green Mark Gold^{PLUS}: 0.5 points

Green Mark Platinum: 0.5 points

Resource Stewardship

P.9 To provide water efficient fittings for common facilities that meet minimum requirements as detailed in the following table

Type of Water Fittings	Prescribed Rating based on Water Efficiency Labelling Scheme (WELS)
Basin Taps & Mixers	✓✓✓
Sink Taps & Mixers	✓✓
Shower Taps, Mixers or Showerheads	✓✓
Dual Flush Flushing Cisterns	✓✓

P.10 Minimum scores under 3.2a Sustainable Construction

Green Mark Gold ≥ 0.5 points

Green Mark Gold^{PLUS} ≥ 2 points

Green Mark Platinum ≥ 3.5 points

P.11 Minimum scores under 3.2b Embodied Energy

Green Mark Gold^{PLUS} ≥ 1 point

Green Mark Platinum ≥ 1 point

P.12 Minimum score under 3.2c Sustainable Products

Green Mark Gold ≥ 2 points

Green Mark Gold^{PLUS} ≥ 3 points

Green Mark Platinum ≥ 4 points

¹ A building's footprint refers to the area on a project site used by the building structure, defined by the perimeter of the building plan. Open car park spaces, landscape, underground construction and non-building facilities (such as covered walkways) are not included in the building footprint.

Smart and Healthy Building

P.13 To limit the use of high VOC emitting building and furnishing materials to improve indoor air quality for the health and well-being of occupants.

The internal paints shall be certified by an approved local certification body and test methods shall comply with ISO 17895 or ISO 11890. All coats of paint shall be considered, including primers, sealers, base coats and top coats.

Green Mark RB: 2016 Criteria

Part 1 - Climatic Responsive Design	Green Mark Points
1.1 Leadership	
<p><u>1.1a Climatic & Contextually Responsive Brief</u></p> <p>Conceptualization of clear environmental sustainability targets and design approaches early at the onset of the project. The brief should include;</p> <p>(a) Preliminary definition of the client’s sustainable aspirations for the project and identification of its green potential benchmarked against similar projects.</p> <p>(b) Setting of agreed achievable sustainability targets for the project. In addition to the project’s targeted Green Mark rating, such targets should involve specific sustainable outcomes and indicators.</p>	<p>Cap at 1 point</p> <p>1 point</p>
<p><u>1.1b Integrative Design Process</u></p> <p>Develop collaborative framework for the project team during the briefing, concept design and technical design phase to address the various needs of all stakeholders to achieve the common targets resulting in a more balanced and optimized design outcome.</p>	<p>Cap at 2 points</p> <p>2 points</p>
<p><u>1.1c Environmental Credentials of Project Team</u></p> <p>This pertains to the appointment of environmental specialists at building design, construction and operations stages.</p> <p>Green Individuals:</p> <ul style="list-style-type: none"> Green Mark Accredited Professional (GM AP) or Green Mark Accredited Facilities Professional (GM AP (FM)) and Green Mark Advanced Accredited Professional (GM AAP) or Green Mark Advanced Accredited Facilities Professional (GM AAP (FM)). <p>Green and Gracious Builder:</p> <p>The main builder is a BCA certified Green and Gracious Builder.</p> <p>Green Companies:</p> <ul style="list-style-type: none"> at least 3 of the following companies are ISO 14001 certified: Architect, M&E Engineer, C&S Engineer, Developer and Main Contractor. SGBC Green Services Certified firm. 	<p>Cap at 2 points</p> <p>0.25 point for GM AP or GM AP(FM) 0.5 point for GM AAP or GM AAP(FM) (Up to 0.5 point for Green Individuals)</p> <p>0.25 point for Certified and Merit; or 0.5 point for Excellent and Star rating (Up to 0.5 point for Green & Gracious Builder)</p> <p>0.5 point</p> <p>0.5 point (Up to 1.5 points for Green Companies)</p>

<p><u>1.1d Building Information Modelling</u></p> <p>(a) Use of BIM between various parties (Architect, the MEP Engineers and the Structural Engineer) in the construction value chain for clash detection purposes.</p> <p>(b) Use of BIM for environmental analysis and building performance simulation.</p>	<p>Cap at 2 points</p> <p>1 point</p> <p>1 point</p>
<p><u>1.1e User Engagement</u></p> <p>This refers to the provision of relevant information and guidance to building occupants as to how they can contribute positively to the reduction of the building's environmental impact.</p> <p>(a) Building User Guide with Green Fit-out Guidelines</p>	<p>Cap at 1 point</p> <p>1 point</p>
<p>1.2 Urban Harmony – Part A</p>	
<p><u>1.2a Sustainable Urbanism</u></p> <p>Minimise environmental impact to the surroundings through site analysis.</p> <p><u>(i) Environmental Impact Statement</u></p> <p>A study/ assessment to be conducted prior to the commencement of activities on-site to identify the anticipated effects on climate change, flora and fauna, soil, air and water that the development may have. It should identify and implement measures to mitigate any adverse impacts, protect valuable site ecology and/ or to improve the site to its original condition.</p> <ul style="list-style-type: none"> • Environmental Study • Comprehensive Environmental Impact Assessment (EIA) <p><u>(ii) Response to Site Context</u></p> <p>A site analysis identifies the relationships between the human and physical geography of the site. It should consider how the urban context, site topography and hydrology, site micro climate, site access and connectivity can inform the design of the urban form and site layout to respond accordingly.</p> <ul style="list-style-type: none"> • Level 1 site analysis and design that demonstrates sensitivity to the site condition • Level 2 analysis optimised design via iterative simulations 	<p>Cap at 5 points</p> <p>1 point</p> <p>2 points (Up to 2 points)</p> <p>1 point</p> <p>3 points (Up to 3 points)</p>

<p><u>(iii) Urban Heat Island (UHI)</u></p> <p>Measures to mitigate the urban heat island effect through the material selection of the hardscape, softscape and building surfaces.</p> <ul style="list-style-type: none"> • ≥50% of site coverage (at plan view) with mitigation measures • ≥80% of site coverage (at plan view) with mitigation measures <p><u>(iv) Green Transport</u></p> <p>To reduce the emissions from vehicular transport through promotion of electric vehicles and bicycle lots.</p> <ul style="list-style-type: none"> • Provision of electrical vehicle charging and parking infrastructure ((at least 1 lot per 100 lots, cap at 5 lots) • Provision of <u>sheltered</u> bicycle lots, in-line with LTA’s quantity requirement 	<p>0.5 point</p> <p>1 point (Up to 1 point)</p> <p>0.5 point</p> <p>1 point (Up to 1 point)</p>												
<p>1.1 Urban Harmony – Part B</p>													
<p><u>1.2b Integrated Landscape and Waterscape</u></p> <p>Integrate a verdant landscape and waterscape into their building design to enhance the biodiversity around the development and provide visual relief to building occupants and neighbours.</p> <p><u>(i) Green Plot Ratio (GnPR)</u></p> <p>The provision of greenery for the development can be quantified via the Green Plot Ratio (GnPR).</p> <p><u>(ii) Tree Conservation</u></p> <p>Encourage preservation of existing trees on-site to prevent disturbance to established habitats</p> <ul style="list-style-type: none"> • preservation of existing trees • replant an equivalent number of similar species of equivalent Leaf Area Index (LAI) 	<p>Cap at 5 points</p> <table border="1" data-bbox="999 1234 1465 1554"> <thead> <tr> <th>GnPR Value</th> <th>Points</th> </tr> </thead> <tbody> <tr> <td>2.5 to < 3.0</td> <td>1.0</td> </tr> <tr> <td>3.0 to < 3.5</td> <td>1.5</td> </tr> <tr> <td>3.5 to < 4.0</td> <td>2.0</td> </tr> <tr> <td>4.0 to < 4.5</td> <td>2.5</td> </tr> <tr> <td>≥ 4.5</td> <td>3.0</td> </tr> </tbody> </table> <p>(Up to 3 points)</p> <p>0.5 point</p> <p>0.5 point (Up to 1 point)</p>	GnPR Value	Points	2.5 to < 3.0	1.0	3.0 to < 3.5	1.5	3.5 to < 4.0	2.0	4.0 to < 4.5	2.5	≥ 4.5	3.0
GnPR Value	Points												
2.5 to < 3.0	1.0												
3.0 to < 3.5	1.5												
3.5 to < 4.0	2.0												
4.0 to < 4.5	2.5												
≥ 4.5	3.0												

<p><u>(iii) Sustainable Landscape Management</u></p> <p>Enhance biodiversity through sustainable landscape management.</p> <ul style="list-style-type: none"> • projects certified under NParks Landscape Excellence Assessment Framework (LEAF) certification • Adoption of native plant species of greenery >50% of the flora selected • Provision of landscape management plan <p><u>(iv) Sustainable Storm Water Management</u></p> <p>To reduce storm surges and improve quality of water entering the public drains through infiltration or design features.</p> <ul style="list-style-type: none"> • projects certified under PUB Active, Beautiful and Clean Waters (ABC Waters) certification OR • Treatment of storm water run-off through the provision of infiltration or design features before discharge to the public drains <ul style="list-style-type: none"> • treatment of $\geq 10\%$ of runoff from total site area 	<p>1 point</p> <p>0.5 point</p> <p>0.5 point</p> <p>(Up to 1 point)</p> <p>1 point</p> <p>0.5 point</p> <p>(Up to 1 point)</p>
1.3 Tropicality	
<p><u>1.3a Tropical Façade Performance</u></p> <p>Enhance the overall thermal performance of building envelope to minimise heat gain thus reducing the overall cooling load when required.</p> <p><u>Baseline</u> : Maximum Permissible RETV = 25 W/m²</p>	<p style="text-align: center;">Cap at 5 points</p> <p>1 points for every reduction of 1 W/m² in RETV from the baseline</p> <p style="text-align: center;">Points awarded = 25- (RETV)</p> <p style="text-align: center;">where RETV \leq 25 W/m²</p>
<p><u>1.3b Internal Organisation</u></p> <p>Design for natural ventilation in following common areas:</p> <p>(a) Lift lobbies and corridors</p> <p>(b) Staircases</p>	<p style="text-align: center;">Cap at 2 points</p> <p style="text-align: center;">Extent of Coverage: 80% of applicable areas</p> <p style="text-align: center;">1 point</p> <p style="text-align: center;">1 point</p>
<p><u>1.3c Ventilation Performance</u></p> <p>Enhance dwelling unit indoor comfort through the provision of good natural ventilation design.</p> <p>(i) Use of ventilation simulation modelling and analysis to identify the most effective building design and layout to achieve good natural ventilation for all selected typical unit types.</p>	<p style="text-align: center;">Cap at 10 points</p>

Step 1

Use of ventilation simulation modelling and analysis to identify the most effective building design and layout to achieve good natural ventilation provided the following primary evaluation parameters can be achieved:

- A minimum 60% of Dwelling Units with window openings facing the prevailing north or north-east and south or south-east directions AND a minimum 2.7 Pa of Global Pressure Differential of Dwelling Units located at building mid height level

OR

- If less than 60% of Dwelling Units with window openings facing the prevailing north or north-east and south or south-east directions, a minimum 4.3 Pa of Global Pressure Differential of Dwelling Units located at building mid height level.

OR

Step 2

Use of ventilation simulation modelling and analysis or wind tunnel testing to identify the most effective building design and layout to achieve good natural ventilation.

Note:

Development scoring for 1.3c (i) Step 2- Ventilation Simulation Modelling is not eligible to score under 1.3c (ii)

OR

Step 3

Thermal comfort modelling shall be performed based on the following PMV equation and comply with the stated PMV range

$$PMV = -11.7853 + 0.4232T - 0.57889V$$

PMV Range	PPD
-0.5 < PMV < +0.5*	< 10*

where PMV is Predicted Mean Vote

PPD is Predicted Percentage Dissatisfied

T is indoor air temperature (°C). Baseline of T is 29.5°C

V is indoor wind speed (m/s)

3 points if the development has good natural ventilation – i.e. a minimum 70% of the selected units with minimum weighted average wind velocity of 0.60 m/s

Points scored = (% of selected typical units with good natural ventilation)/7
(up to 10 points)

1 point if the development complies with the thermal comfort criteria

<p>(ii) Effective building layout design and unit design reduce the need for using air-conditioning.</p> <p>Design for air flow within dwelling units</p> <ul style="list-style-type: none">• <u>Building layout design</u>: Proper design of building layout that utilizes prevailing wind conditions to achieve adequate cross ventilation.• <u>Dwelling unit design</u>: Good ventilation in indoor units through sufficient openings. <p>Note:</p> <p><i>Development scoring for <u>1.3c (i) Ventilation Simulation Step 2</u> is not eligible to score under 1.3c (ii)</i></p>	<p>0.5 point for every 10% of units with window openings facing north AND south directions</p> <p>0.5 point for every 10% of living rooms and bedrooms designed with true cross ventilation</p> <p>(Up to 7 points)</p>
---	--

Part 2 – Building Energy Performance	Green Mark Points						
2.1 Energy Efficiency							
<p>2.1a Air Conditioning System Efficiency</p> <p>Use energy efficient air-conditioners.</p> <p>The project team shall demonstrate through ventilation simulation modelling and analysis e.g. computer fluid computation (CFD) to ensure that hot air can be effectively discharged and the declared efficiency of the air-conditioning system can achieve. Details for the housing of the condenser units such as clearance spaces and screens shall be considered.</p> <p>Note:</p> <p>For developments where air-conditioners are not provided, points will be scored and prorated under 1.3c i) for Ventilation Performance</p>	<p>Cap at 6 points</p> <p>Air-conditioners with the following energy performance:</p> <table border="1" data-bbox="911 443 1390 645"> <thead> <tr> <th>Air Conditioners with</th> <th>Points</th> </tr> </thead> <tbody> <tr> <td>COP_{100%} ≥ 4.29 and weighted COP ≥ 4.86</td> <td>3</td> </tr> <tr> <td>COP_{100%} ≥ 4.86 and weighted COP ≥ 5.50</td> <td>5</td> </tr> </tbody> </table> <p>Extent of coverage: At least 80% of dwelling units</p> <p>1 point for using CFD to ensure effectiveness</p> <p>OR</p> <p>0.5 point for design with adequate clearance distance for condenser units and screens for condenser units shall be more than or equal to 70% of free area</p>	Air Conditioners with	Points	COP _{100%} ≥ 4.29 and weighted COP ≥ 4.86	3	COP _{100%} ≥ 4.86 and weighted COP ≥ 5.50	5
Air Conditioners with	Points						
COP _{100%} ≥ 4.29 and weighted COP ≥ 4.86	3						
COP _{100%} ≥ 4.86 and weighted COP ≥ 5.50	5						
<p>2.1b Lighting Efficiency</p> <p>Encourage the use of energy efficient lighting in common areas to minimise energy consumption from lighting usage while maintaining proper lighting level.</p> <p><u>Baseline</u> = Maximum lighting power budget stated in SS530</p>	<p>Cap at 4 points</p> <p>0.12 point for every percentage improvement in the lighting power budget above 10% improvement over baseline</p> <p>Points scored = 0.12 x (% improvement-10%)</p>						
<p>2.2c Car Park Energy</p> <p>Encourage the use of energy efficient design and control of ventilation systems in car parks</p> <p>a) Car parks are designed with natural ventilation</p> <p>b) Mechanical ventilated car parks with CO sensors installed to regulate the ventilation required.</p> <p>Note:</p> <p>Where there is a combination of different ventilation mode adopted for car park design, the points obtained will be prorated accordingly</p>	<p>Cap at 2 points</p> <p>Naturally ventilated car parks – 2 points</p> <p>Mode of mechanical ventilation provided</p> <p>Fume extract – 1.5 points</p> <p>Mechanical ventilated with or without supply (air) – 1 point</p>						

2.2 Energy Effectiveness	
<p><u>2.2a Energy Efficient Practices, Design and Features</u></p> <p>Encourage the use of energy efficient features which are innovative and have positive environmental impact.</p> <p>Use of the following energy efficient features such as:</p> <ul style="list-style-type: none"> (i) Gas water heater or energy efficient heat pump water heater (ii) Heat recovery system (iii) Re-generative lift (iv) Energy labelled appliances such as 4 ticks refrigerator, 5 ticks clothes dryer and 5 ticks TV (v) Calculation of Energy Efficiency Index (EEI) (vi) Others 	<p style="text-align: center;">Cap at 5 points</p> <p style="text-align: center;">1 point for high impact item \geq 80% 0.5 point for low impact item \geq 50%</p>
2.3 Renewable Energy	
<p><u>2.3a Feasibility Study</u></p> <p>To conduct a feasibility study on harnessing solar energy, covering the intent, scope and assessment of the proposed project, the technical and financial aspects and also include roof spatial optimisation.</p>	<p style="text-align: center;">Cap at 0.5 point</p> <p style="text-align: center;">0.5 point</p>
<p><u>2.3b Solar Ready Roof</u></p> <p>Solar ready roof includes the structural readiness, roof layout and electrical readiness provision as follows:</p> <ul style="list-style-type: none"> • Structural readiness: Roof to be designed to accommodate an optimised easy structural installation of solar panels on rooftop spaces • Electrical readiness: Provisions to be put in place to accommodate an optimised easy electrical installation of solar panels on rooftop spaces • Spatial readiness: Roof to be designed to optimise the available non-shaded rooftop area for photovoltaic adoption of roof spatial optimization. 	<p style="text-align: center;">Cap at 1.5 points</p> <p style="text-align: center;">0.5 point each</p>
<p><u>2.3c Replacement Energy</u></p> <p>To encourage annual replacement of electricity (based on building electricity consumption) by renewable energy.</p>	<p style="text-align: center;">Cap at 6 points</p> <p style="text-align: center;">1 point for every 1% replacement of electricity replacement (exclude household's usage) by renewable energy</p>

Part 3 – Resource Stewardship	Green Mark Points									
3.1 Water										
<p>3.1a Water Efficiency Measures</p> <p>Reduce potable water consumption through the use of water efficient fittings/products and systems</p> <p>(i) Dwelling units – Provision of products that are certified under WELS</p> <ul style="list-style-type: none"> • Basin taps and mixers • Sink taps and mixers • Shower taps and mixers or Showerheads • Dual Flush flushing cisterns • Clothes washing machines <p>(ii) Provision of water efficient automated irrigation system and/or drought tolerant plants.</p> <ul style="list-style-type: none"> • Automated irrigation system with sensor control • Drought tolerant plant 	<p style="text-align: center;">Cap at 9 points</p> <table border="1" style="width: 100%; border-collapse: collapse;"> <tr> <td colspan="2" style="text-align: center;">Rating based on Water Efficiency Labelling Scheme (WELS)</td> <td rowspan="4" style="text-align: center; vertical-align: middle;">Points scored based on the number, water efficiency rating of the products used</td> </tr> <tr> <td style="text-align: center;">Very Good</td> <td style="text-align: center;">Excellent</td> </tr> <tr> <td colspan="2" style="text-align: center;">Weightage</td> </tr> <tr> <td style="text-align: center;">6</td> <td style="text-align: center;">7</td> </tr> </table> <p style="text-align: center;">Up to 7 points</p> <p style="text-align: center;">0.5 point for every 25% of landscape area served 0.5 point for every 20% of landscape area (Up to 2 points)</p>	Rating based on Water Efficiency Labelling Scheme (WELS)		Points scored based on the number, water efficiency rating of the products used	Very Good	Excellent	Weightage		6	7
Rating based on Water Efficiency Labelling Scheme (WELS)		Points scored based on the number, water efficiency rating of the products used								
Very Good	Excellent									
Weightage										
6	7									
<p>3.1b Water Usage Monitoring</p> <p>Facilitate setting of water consumption reduction targets and continual monitoring through the provision of water meters for major water uses.</p> <p>(i) Private meters</p> <p>(ii) Smart remote metering system</p>	<p style="text-align: center;">Cap at 1 point</p> <p style="text-align: center;">0.5 point 1 point</p>									
<p>3.1c Alternative Water Sources</p> <p>Encourage the use of alternative water sources to reduce potable water consumption for general application and use</p> <p>(i) NEWater supply</p> <p>(ii) On-site recycled water</p> <p>(iii) Rainwater harvested</p>	<p style="text-align: center;">Cap at 3 points</p> <p style="text-align: center;">1 point 1 point 1 point</p>									
3.2 Materials										
<p>3.2a Sustainable Construction</p> <p>(i) Conservation and Resource Recovery</p> <p>To reward conservation of existing building structures and recovery of demolished building materials for reuse or recycling.</p> <p>Where existing building structures on site are demolished, 1 point can be awarded for enhanced demolition protocol, where a recovery rate of >35%</p>	<p style="text-align: center;">Cap at 8 points</p> <p style="text-align: center;">1 point</p>									

crushed concrete waste from the demolished building is sent to approve recyclers with proper facilities.

ii) Resource Optimisation

Part 1. Concrete Usage Index (CUI)

To optimise concrete use through the calculation of the project's Concrete Usage Index (CUI) and encourage adoption of sustainable building systems.

Adoption of sustainable building systems

Examples of sustainable building systems:

- Pre-stressed Concrete Elements
- Hollow Core or Voids Concrete Elements
- Light Weight Concrete Elements
- *High Strength Concrete Elements
- Structural Steel Elements
- Composite Structural Elements
- Engineered Timber Elements
- Prefabricated Prefinished Volumetric Construction (PPVC)
- Precast Concrete Elements
- Leave-in Formwork
- Others (to be accepted by BCA on a case-by-case basis)

*Refers to concrete grade >60MPa

Criteria	Points
CUI	Cap at 4 points
Adoption of Sustainable Building Systems	

CUI:

Points shall be scored for CUI are based on the following table:

Table 3.02a-1 CUI scoring Matrix:

Project's CUI	Points
≤ 0.60	0.5
≤ 0.50	1
≤ 0.45	1.5
≤ 0.40	2
≤ 0.35	2.5

Adoption of sustainable building systems

Points shall be scored for the adoption of key/distinctive sustainable building systems (refer to Table below) based upon the extent of their use as a percentage of the constructed floor area (CFA).

Extent of use	Points
Total coverage area <50% of CFA	0.5
Total coverage area ≥50% and < 75% of CFA	1
Total coverage area ≥ 75% of CFA	1.5

(Up to 1.5 pts for adoption of sustainable building system)

<p><u>Part 2. Low-Carbon Concrete</u></p> <p>To replace the use of concrete within a project with green cements and recycled aggregates</p> <p>Applicable for superstructure works only.</p>	<p style="text-align: center;">Cap at 3 points</p> <p><u>Use of recycled/ engineered aggregates e.g. RCA and WCS</u></p> <p>0.5 points can be scored for every 5% replacement by mass of coarse and/or fine aggregates with recycled/ engineered aggregates from approved sources for the superstructure concrete.</p> <p>However, the use of coarse and fine recycled/ engineered aggregates in structural applications shall be limited to 10% replacement by mass unless approval is obtained from the relevant authorities.</p> <p>Usage should not fall below 1.5% x GFA for coarse recycled/ engineered aggregates and 0.75% x GFA for fine recycled/engineered fine aggregates.</p> <p style="text-align: center;">(Up to 1 point)</p> <p><u>Clinker Content:</u></p> <p>Up to 2 points can be scored for the use of concrete containing clinker ≤ 400 kg/m³ for grades up to C50/60 for $\geq 80\%$ of the applicable super-structural concrete by volume, according to the performance requirements in the specifications. Tiered points will also be awarded for using concrete certified by SGBC based on the extent of environmental friendliness.</p> <table border="1" data-bbox="852 1093 1439 1422"> <thead> <tr> <th>*Concrete Categories</th> <th>Points (or points tier)</th> </tr> </thead> <tbody> <tr> <td>Uncertified concrete with clinker content ≤ 400 kg/m³</td> <td>0.5</td> </tr> <tr> <td>SGBC-certified 1-Tick concrete</td> <td>1.0</td> </tr> <tr> <td>SGBC-certified 2-Tick concrete</td> <td>1.5</td> </tr> <tr> <td>SGBC-certified 3-Tick concrete</td> <td>2.0</td> </tr> </tbody> </table> <p><i>*Note: All SGBC-certified concrete are deemed to have fulfilled the requirement of clinker content < 400kg/m³</i></p> <p style="text-align: center;">(Up to 2 points)</p>	*Concrete Categories	Points (or points tier)	Uncertified concrete with clinker content ≤ 400 kg/m ³	0.5	SGBC-certified 1-Tick concrete	1.0	SGBC-certified 2-Tick concrete	1.5	SGBC-certified 3-Tick concrete	2.0
*Concrete Categories	Points (or points tier)										
Uncertified concrete with clinker content ≤ 400 kg/m ³	0.5										
SGBC-certified 1-Tick concrete	1.0										
SGBC-certified 2-Tick concrete	1.5										
SGBC-certified 3-Tick concrete	2.0										
<p>3.2b Embodied Energy</p> <p>This involves the computation of the carbon footprint of the development and the building life cycle analysis to better quantify the environmental impact of a building and raise awareness among key decision makers.</p>	<p style="text-align: center;">Cap at 2 points</p> <p>Use of BCA Online Embodied Carbon Calculator to compute carbon emission of various building materials (as shown in table below)</p> <p>Up to 2 points can be scored for computing the carbon footprint of the development:</p> <table border="1" data-bbox="852 1814 1407 2069"> <thead> <tr> <th>Description</th> <th>Points</th> </tr> </thead> <tbody> <tr> <td>Declaration of Concrete, Glass and Steel</td> <td>1</td> </tr> <tr> <td>Declaration of additional materials</td> <td>0.25 points per material (cap at 1 point)</td> </tr> </tbody> </table>	Description	Points	Declaration of Concrete, Glass and Steel	1	Declaration of additional materials	0.25 points per material (cap at 1 point)				
Description	Points										
Declaration of Concrete, Glass and Steel	1										
Declaration of additional materials	0.25 points per material (cap at 1 point)										

3.02c Sustainable Products

(i) Functional Systems

The use of material and products in a building has a direct impact on the quality of the environment.

Reduced use of products should be encouraged to reduce waste and embodied carbon in buildings.

Where building uses only necessary and required products; such products should be those certified by the approved local certification bodies to help designers and consumers make informed choice in selecting products that are manufactured responsibly and has low or no emission that is detrimental to the wellbeing of the users and occupants.

Products used in building are categorized into 6 functional systems and a singular products category and points are scored by categories.

(ii) Singular Sustainable Products outside of Functional Systems

To encourage the use of sustainable products that do not fall into the functional systems such as

- Hardscape - Includes items such as composite timber decking, outdoor play equipment, pre-cast kerbs and drains, wheel stoppers in car parks, drainage cells etc.

Cap at 8 points

Whole building (include residential units)

Functional System Category	Base Group (To score this group prior to score for Finishes Group)	Finishes Group
	Coverage >60%	Coverage >60%
Internal Wall	1	2
Internal Floor	1	2
External Wall	1 (coverage >80%)	2 (coverage >80%)
Roof	0.5 (coverage >80%)	0.5 (coverage >80%)
Doors	1	0.5
Ceiling	0.5	0.5

Common area only (exclude residential units)

Functional System Category	Base Group (To score this group prior to score for Finishes Group)	Finishes Group
	Coverage >80%	Coverage >80%
Internal Wall	0.5	1
Internal Floor	0.5	1
External Wall	1	2
Roof	0.5	0.5
Doors	0.5	0.25
Ceiling	0.25	0.25

Note: The coverage for External wall and Roof system shall be >80% for both tables

(Up to 6 points)

Singular products category	Coverage >80%
Hardscape & Softscape & Building Equipment & Fixtures etc.	0.25 point per product

<ul style="list-style-type: none"> • Building services - Mechanical, electrical and plumbing equipment or products such as chillers, circuit boards, transformers, water pipes 	<p>0.25 point for each product used for $\geq 90\%$ of the applicable use</p> <p>(Up to 2 points)</p>
<p>3.3 Waste</p>	
<p>3.03a Environmental Construction Management Plan</p> <p>Encourage holistic environmental management plan to facilitate better environmental performance of construction process and waste minimisation.</p>	<p>Cap at 1 point</p> <p>1 point</p>
<p>3.3b Operational Waste Management</p> <p>Encourage the provision of dedicated facilities for recycling purposes.</p> <p>(i) Provision of recycling facilities in common areas for collection and storage of different recyclable waste such as paper, glass, metal and plastic in commingled or sorted form.</p> <p>(ii) Provision of facilities for the storage and composting of horticultural waste in common areas.</p> <p>(iii) Web portal or dashboard which promotes recycling efforts</p>	<p>Cap at 3 points</p> <p>1 point</p> <p>1 point</p> <p>1 point</p>

Part 4 – Smart and Healthy Building	Green Mark Points
4.1 Indoor Air Quality	
<p>4.1a Occupant Comfort</p> <p>For design taking into account of non-prevailing wind and without the use of air-conditioner:</p> <p>To encourage provision of assisted mechanism to achieve thermal comfort for occupant residential spaces</p>	<p>Cap at 2 points</p> <p>For living room only - 1 point</p> <p>For all living room, bedrooms – 2 points</p>
<p>4.1b Contaminants</p> <p>(i) More Stringent VOC Limits for Interior Fittings and Finishes</p> <p>Minimise airborne contaminants, mainly from inside sources to promote a healthy indoor environment. To encourage use of low VOC emitting interior finishes that are certified by approved local certification bodies</p> <ul style="list-style-type: none"> • Adhesives & sealants (including tile grouting) • Floor coverings such as carpets, laminates and vinyl flooring (excluding tiles) • Ceiling coverings such as ceiling boards, • Wall coverings (excluding tiles) • Varnish, stains, lacquers or other trims (including doors and furniture) <p>(ii) Waste Disposal</p> <p>Minimise airborne contaminants from waste by locating refuse chutes or waste disposal area at open ventilated areas such as service balconies or common corridors.</p> <p>(iii) Indoor Air Quality in Wet Areas</p> <p>Provision of adequate natural ventilation and daylighting in wet areas such as kitchens, bathrooms and toilets. Fumes from stove(s) should be adequately ventilated to exterior, instead of spreading to other occupied spaces</p>	<p>Cap at 6 points</p> <p>Points scored based on extent of coverage and the % of applicable areas with such provision:</p> <p>1 point for one main category of finishes (excluding tiles) for ≥ 90% of applicable areas</p> <p>3 points for all finishes for ≥ 90% of applicable areas</p> <p>(Up to 3 points)</p> <p>1 point</p> <p>Points scored based on the % of applicable areas with such provision</p> <p>1 point for 50% to 90% of applicable areas</p> <p>2 points for ≥ 90% of applicable areas</p> <p>(Up to 2 points)</p>

4.2 Spatial Quality	
4.2a Lighting	Cap at 5 points
<p><u>(i) Effective Daylighting</u></p> <p>To encourage effective daylighting and potential for visual discomfort mitigation strategies in residential units; in bedrooms, living room, family room and study room.</p> <p>Two methods are available for evaluating and reporting of daylight provision</p> <p>(i) Pre-simulated Daylight Availability Tables Methodology</p> <p>(ii) Full simulation – refer to Simulation guideline</p>	<p><u>For Exemplary Daylit Dwelling Design</u></p> <p>Where each Residential unit to meet DA200lux,50%; with minimum 75% of applicable area of the unit to qualify to be included in the count of number of residential units are daylit. The area qualifying 75% of the applicable area shall encounter overnighiting.</p> $\frac{\text{Total Residential Units meet the daylit requirement}}{\text{Total Number of Units}} \times 100\% \times 3 \text{ points}$ <p><u>For acceptable Daylit Dwelling Design</u></p> <p>Where each Residential units to meet DA200lux,50%; with minimum in 60% of applicable area of the unit to qualify in the count of number of residential units are daylit. The area qualifying 60% of the applicable area shall encounter overnighiting.</p> $\frac{\text{Total Residential Units meet the daylit requirement}}{\text{Total Number of Units}} \times 100\% \times 2 \text{ points}$ <p style="text-align: center;">(Up to 3 points)</p>
<p><u>(ii) Potential Glare and daylight control measures</u></p> <p>Simple strategies to allow building occupants to adjust their environment to reduce discomfort glare during certain times of the day, whilst allowing effective daylight to enter functional areas</p>	<p>Provision of any of the following strategies for at least 90% of residential units with glare:</p> <ul style="list-style-type: none"> • Blinds and Screens • Light shelf • Glazing treatments (Variable opacity glazing, bi-level glazing) <p>Note: for projects using simulation method; the strategies used for glare mitigation must be shown in simulation that it is effective in mitigation.</p> <p style="text-align: center;">(0.5 point)</p>
<p><u>(iii) Daylighting in common areas</u></p> <p>To encourage effective daylighting</p> <p>(i) Staircases</p> <p>(ii) Corridors & Lift Lobbies</p> <p>(iii) Car parks</p>	<p>The provision of daylit spaces will be prorated to the extent of coverage (by number)</p> <p style="text-align: center;">0.5 point each (prorated by numbers)</p> <p style="text-align: center;">(Up to 1.5 points)</p>

4.2b Acoustics	Cap at 2 points
<p><u>(i) Acoustics Planning</u></p> <p>Architectural design to avoid windows of living rooms and bedrooms to be in immediate proximity/facing to noise sources within site boundary and 70 metres away from building boundary.</p> <p>Noise sources include:</p> <ol style="list-style-type: none"> 1) Category 1 and category 2 road 2) MRT tracks and stations 	1 point
<p><u>(ii) Acoustics Design</u></p> <p>Acoustic design report meeting relevant authority's requirement with an aggregate area of not less than 10% of the room/space to be ventilated. Credit is given for implementation of recommendations stated in the report to meet acoustic requirement.</p>	1 point
4.2c Wellbeing	Cap at 2 points
<p><u>(i) Biophilic Design</u></p> <p>Including elements of nature in comfortable spaces to nurture the human-nature relationship is important for the health and happiness of the building users.</p> <ol style="list-style-type: none"> i) Provision of nature in common areas: <ol style="list-style-type: none"> a) Daylighting and natural ventilation b) Water features c) Extensive greenery d) Fauna, beyond insect species e) Natural landscape and ecosystems ii) Provision of indirect experience of nature in building design: <ol style="list-style-type: none"> a) Images of nature b) Use of natural materials like wood and stone c) Use of natural colours d) Adoption of naturalistic shapes and forms (including plants and animals) e) Demonstrate the passage of time and age f) Use of natural geometrics including "Golden Ratio" and "Fibonacci Sequence" g) Adoption of biomimicry (such as super tree structure in Garden by the Bay) 	<p style="text-align: center;">Adoption of Biophilic and Wellbeing Design</p> <p style="text-align: center;">0.15 point per element</p> <p style="text-align: center;">(Up to 1 point)</p> <p style="text-align: center;"><i>Additional 1 point can be scored under Advanced Green Effort – 5.4 Social Benefits</i></p>

<p>iii) Provision of features to facilitate experience of space and place:</p> <ul style="list-style-type: none"> a) Design incorporating at least 2 distinct areas of prospect and refuge such as balconies, designated lookout areas along corridors b) Design incorporating organised complexity such as complicated patterned façade design c) Design incorporating integration of parts to wholes d) Provision of at least 3 different transitional environments between spaces such as sheltered walkway to car park, porches that link indoor to outdoor areas. e) Facilitate wayfinding in terms of locality and map provision in the whole development f) Designate as least 2 cultural defined locations <p>iv) Provision of space in common areas for lifestyle wellbeing:</p> <ul style="list-style-type: none"> a) Designated gardening/farming areas b) Playground c) Fitness corner d) Dedicated running tracks with marked distance information e) Designated areas for wellness activities with peaceful ambience 	
<p><u>(ii) Universal Design Mark</u></p> <p>Adopt a user-centric philosophy in design, operations and maintenance.</p>	<p>UD Mark Certified or Gold Award (0.5 point)</p> <p>UD Mark Gold^{PLUS} or Platinum Award (1 point)</p>
<p>4.3 Smart Building Operations</p>	
<p><u>4.3a Energy Monitoring</u></p> <p>To encourage tracking a building and residents' energy use with data presented in a relevant manner to engage occupants to be involved in managing energy consumption, through open standards to future-proof</p>	<p>Cap at 2 points</p>

<p>the building's network and facilitate exchange of data with other systems.</p> <ul style="list-style-type: none"> • Provision of a power meter with dashboard in the form of digital displays in common areas, or web-based and mobile applications. • Provision of a power meter with dashboard made available to residents / occupants, showing the energy consumption in their respective dwellings. • Using BACnet, Modbus or any other non-proprietary protocol as the network backbone for the building management system (BMS), with the system being able to provide scheduled export of a set of any chosen data points to commonly used file formats. 	<p>0.5 point</p> <p>0.5 point</p> <p>1 point</p>
<p>4.3b Demand Control</p> <p>To encourage adoption of automated controllers in managing energy/ resources consumption in the common areas of residential developments.</p> <ul style="list-style-type: none"> • Provision of timer sensors / controls for lighting and ventilation systems in community spaces such as link buildings, community halls, etc. • Provision of Bi-level motion sensors for artificial lighting systems in >80% of the common areas. • Provision of car park guidance system in multi-storey car parks. • Others (to be accepted by BCA on a case-to-case basis) 	<p>Cap at 2 points</p> <p>0.5 point each</p>
<p>4.3c Integration and Analytics</p> <p>To encourage innovative and integrative use of sensor and motion data for optimizing or attaining persistence of high performance and energy efficiency of the residential development.</p> <ul style="list-style-type: none"> • Provision of website and/or accessible monthly readout per residential block / unit to engage residents. • Provision of energy portal and/or dashboard for residential development management team. • Others (to be accepted by BCA on a case-to-case basis) 	<p>Cap at 2 points</p> <p>1 point each</p>

<p><u>4.3d System Handover and Documentation</u></p> <p>To encourage systems verification and to ensure operational continuity from construction to building maintenance and operation.</p> <ul style="list-style-type: none"> • Proper system verification and handover of higher-order functional and system level performance of buildings control systems, mechanical systems and electrical systems. The project shall demonstrate a commitment to comply with verification requirements and show evidence of relevant schedules and documentation per residential block. • Proper system verification and handover of applicable mechanical and electrical systems. The project shall demonstrate a commitment to comply with verification requirements and show evidence of relevant schedules and documentation per residential unit. 	<p>Cap at 2 points</p> <p>1 point</p> <p>1 point</p>
--	---

Part 5 – Advanced Green Efforts	Green Mark Points
5.1 Enhanced Performance	Cap at 15 points
<p><u>5.1a Passive Design Strategies</u></p> <p>To encourage design that optimises prevailing wind conditions and facilitates air flow such as</p> <ul style="list-style-type: none"> • For development with multiple blocks, staggering the blocks such that blocks behind are able to receive wind penetrating through the gaps between the blocks in the front row or arrange building according to ascending height with lower height in front and towards the direction of prevailing wind • Provision of either void decks at the ground floor or void spaces in between buildings to encourage air flow through and around buildings • Carry out macro ventilation simulation to check block layout to ensure passive design been considered from the early design stage 	<p>Extent of Coverage: 80% of applicable areas</p> <p>1 point for each strategy (Up to 3 points)</p>
<p><u>5.1b Sustainable Stormwater Management</u></p> <p>To reduce storm surges and improve quality of water entering the public drains through infiltration or design features.</p>	<p>1 point for projects certified under PUB ABC Waters ‘Gold Class’ certification</p>
<p><u>5.1c Wind Driven Rain Simulation</u></p> <p>To encourage design that uses wind driven rain simulation modelling to identify effective building design and layout that minimises the impact of wind-driven rain into naturally ventilated common areas such as lift lobbies and corridor areas where there might be concerns, drop-off area and communal space such as sky garden.</p>	<p>1 point to conduct wind driven rain simulation to identify effective building design and layout</p> <p>1 point for implementation of recommendations</p>
<p><u>5.1d Energy Efficient Features</u></p> <p>To encourage the use of energy efficient features which are innovative and have positive environmental impact in terms of energy saving.</p> <ul style="list-style-type: none"> • Use of thermal insulation or cool paints on the east and west facing external walls • Provision of vertical greenery system on building facades abutting the living rooms, dining areas and bedrooms of dwelling units 	<p>1 point for window to wall ratio (WWR) of less than 0.5 0.5 point for WWR that is between 0.5 to 0.8</p> <p>2 points for more than 50% of building facades 1 point for at least 25% of building facades</p>

<p>5.1e Additional Replacement Energy</p> <p>To encourage additional replacement of electricity (based on building electricity consumption) by renewable energy.</p>	<p>% replacement of electricity (exclude household's usage) by renewable energy</p> <p>1 point for every 10%</p> <p>(Up to 10 points)</p>							
<p>5.1f Smart Water Management System</p> <p>Provision of smart home water management system to facilitate further water reduction opportunities and to encourage water saving habits.</p> <ul style="list-style-type: none"> • System/device that allows homeowners to access to their own water usage data • System/device that provides homeowners the breakdown of their major water uses 	<p>1 point</p> <p>2 points</p>							
<p>5.1g Smart BIM</p> <p>To encourage the use of Smart BIM:</p> <ul style="list-style-type: none"> • 4D(Time) BIM • 5D(Cost) BIM • 6D(Facilities Management) BIM <p>To use BCA supported BIM based Concrete Usage Index (CUI) calculator to calculate CUI.</p>	<p>1 point each</p> <p>1 point</p> <p>(Up to 3 points)</p>							
<p>5.1h Sustainable Products</p> <p>To encourage the use of products with a Very Good rating (2 ticks) or above under the Singapore Green Building Product (SGBP) certification scheme.</p>	<table border="1"> <thead> <tr> <th></th> <th>Tick Rating</th> </tr> </thead> <tbody> <tr> <td rowspan="4">Additional Green Effort (by products)</td> <td>2 ticks- 0.25</td> </tr> <tr> <td>3 ticks- 0.5</td> </tr> <tr> <td>4 ticks- 1</td> </tr> <tr> <td>(Functional system and Singular Products - Up to 2 points)</td> </tr> </tbody> </table>		Tick Rating	Additional Green Effort (by products)	2 ticks- 0.25	3 ticks- 0.5	4 ticks- 1	(Functional system and Singular Products - Up to 2 points)
	Tick Rating							
Additional Green Effort (by products)	2 ticks- 0.25							
	3 ticks- 0.5							
	4 ticks- 1							
	(Functional system and Singular Products - Up to 2 points)							

<p>5.1i Embodied Energy</p> <p>To encourage additional effort in the computation of the carbon footprint of the development and the building life cycle analysis to better quantify the environmental impact of a building and raise awareness among key decision makers, such as:</p> <ul style="list-style-type: none"> • Provide own material emission factors through BCA's online embodied carbon calculator • Computing the carbon footprint of the entire development and develop detailed carbon footprint report based on ALL the materials used within the project. (2 points) 	<p>0.25 points per material (Up to 1 point)</p> <p>2 points</p> <p>(Up to 3 points)</p>
<p>5.1j Clean Outdoor Air</p> <p>Provision of a space/room in the unit with minimum outdoor air in occupant space when windows are closed, particularly when there is poor outdoor air quality condition</p>	<p>Provision of clean outdoor air (2 points) [0.3 l/s per m² floor area for that space/room]</p> <p>Provision of portable air cleaner for more than 80% of the units (0.5 point)</p> <p>(Up to 2 points)</p>
<p>5.1k Smart Building Operations</p> <p>To encourage innovative smart building operations.</p> <ul style="list-style-type: none"> • Car park data collection system with open-protocol support for lighting / space control • Integration of systems for energy savings, etc. • Mobile application for monitoring / controlling of electrical / water consumption 	<p>1 point</p> <p>0.5 point</p> <p>0.5 point</p>
<p>5.1l Displaying Green Building Credential</p> <p>To identify and distinguish exemplary development which are green and sustainable. The development to display the Green Mark plaque/decal at prominent location (e.g. main lobby).</p>	<p>1 point</p>

<p><u>5.1m Façade Design Strategies</u></p> <p>To encourage façade design that improve thermal comfort of dwelling units</p> <ul style="list-style-type: none"> • For development with WWR ≤ 0.5 and at least 70% of units with cross ventilation and facing north and/or south • Use monsoon windows* that allow the outdoor air to flow into indoors without rain • For development with gable walls designed with better thermal insulation (e.g. a layer of air gap, polystyrene, etc) 	<p>1 point for each strategy (Up to 2 points)</p>
<p><u>5.1n Other green features</u></p> <p>To encourage the use of other green features that are innovative and have positive environmental impact.</p>	<p>Extent of coverage: 80% of the applicable equipment type or product</p> <p>1 point for high impact item $\geq 80\%$ 0.5 point for low impact item $\geq 50\%$ (Up to 2 points)</p>
<p>5.2 Demonstrating Cost Effective Design</p>	<p>Cap at 2 points</p>
<p><u>5.2a Cost neutral design</u></p> <p>To encourage projects that can demonstrate that they have achieved high levels of environmental performance without an increased capital expenditure.</p> <p>The project is designed with zero green premium when compared to conventional building design that meets the code and regulatory requirements.</p>	<p>2 points</p>
<p>5.3 Complementary Certifications</p>	<p>Cap at 1 point</p>
<p><u>5.3a Complementary certifications</u></p> <p>To encourage the use of an approved local or international rating tool that rates sustainability beyond the built environment.</p>	<p>1 point</p>
<p>5.4 Social Benefits</p>	<p>Cap at 2 points</p>
<p><u>5.4a Social benefits</u></p> <p>To encourage projects that demonstrate their social benefits or how social sustainability has been incorporated into the project. This can (but not limited to) include efforts that demonstrate enhanced considerations to wellbeing, community integration efforts and clean energy purchase through leasing contracts.</p>	<p>0.5 point each</p>

Design Stage and Verification Requirements

0. Pre-requisite Requirements

The pre-requisites for Green Mark 2016 sets the minimum environmental considerations that a project shall demonstrate based on industry norms. It includes provisions from the Singapore Standards, as well as regulations by other government bodies where relevant. The pre-requisite section has been organised to lead the project team through the various performance requirements necessary to achieve the level of rating desired.

The pre-requisites for respective Green Mark rating must be achieved in order to progress to score Green Mark points in the 5 main green mark sections.

Indicator	Pre-Requisite Requirement	Gold	Gold ^{PLUS}	Platinum
P.1	Greenery Provision	-	2.5pts	
P.2	Residential Envelope and Roof Thermal Transfer	$\leq 25\text{W/m}^2$	$\leq 22\text{W/m}^2$ (3pts)	$\leq 20\text{W/m}^2$ (5pts)
		-	West, south-west and north-west facades of development $\leq 25\text{W/m}^2$	
		The U-value for roof shall not exceed $0.8\text{W/m}^2\text{K}$ for light weight roof, $1.1\text{W/m}^2\text{K}$ for medium weight group, $1.5\text{W/m}^2\text{K}$ for heavy weight roof		
P.3	Ventilation Performance	-	Minimum 70% of selected typical dwelling units with good natural ventilation* Common areas are to be designated as naturally ventilated spaces	
P.4	Air Tightness and Leakage	For windows and curtain water systems, air leakage rates shall not exceed the limit specified in SS212 and SS381 respectively		
P.5	Vertical Transportation Efficiency	All lifts to be equipped with VVVF drives and sleep mode features		
P.6	Air Conditioning System Efficiency	At least 3 ticks -	At least 5 ticks (5pts)	At least 5 ticks (5pts)
P.7	Lighting Efficiency	At least 10% improvement in lighting power budget over baseline		
P.8	Renewable Energy Feasibility Study	For buildings with a footprint $\geq 1,000\text{m}^2$ 0.5pt		
P.9	Water Fittings in Common Facilities	The project shall demonstrate the use of water efficient fittings that meet minimum requirements stated in table		
P.10	Sustainable Construction	0.5pt	2pts	3.5pts
P.11	Embodied Energy	-	1 pt	
P.12	Sustainable Products	2pts	3pts	4pts
P.13	Low Volatile Organic Compound (VOC) Paints	Low VOC paints used for at least 90% of internal painted areas		

Note: * Complementary methods to compliance are available as described in 1.3c

1. Climatic Responsive Design



Buildings serve as structures sheltering their occupants from the variable external climate. With this consideration, the built form should be considered to maximise its response to the local tropical climate, and establish a contemporary tropical vernacular. By appreciating the site context, building designers can capitalise on the physical environment and recognise opportunities for the urban built form to maximise responsive design. Consideration of the building's human centricity and whether it is in sync with its surrounding context should also be given due account. It is paramount for such climatically contextual design to be weaved into the early thinking of building design, and this is enabled through upstream effective leadership, supported by a collaborative process of design with the partnership of relevant stakeholders

P.1 – P.4 Prerequisites

Criteria	Points
1.1 Leadership	8
1.2 Urban Harmony	10
1.3 Tropicality	17
TOTAL	35
<i>Advanced Green Efforts</i>	8

P.1 Greenery Provision

Intent

To enhance biodiversity through the integration of lush greenery provision, preservation of existing trees and sustainable landscape management. In addition, to reduce storm surges and improve quality of water entering the public drains through introduction of waterscape within the development.

Scope

Applicable to all residential buildings.

Applicable for the following Award levels:
Gold ^{PLUS}
Platinum

Assessment

Option 1: Minimum Green Plot Ratio (GnPR):

	Green Plot Ratio
Gold ^{PLUS}	4
Platinum	4

OR

Option 2: For projects with limited scope for green spaces, projects can opt to score 2.0 points for Gold^{PLUS} or 2.5 Points for Platinum under Indicator 1.2b Integrated Landscape and Waterscape.

	GM score under 1.2b
Gold ^{PLUS}	2.5
Platinum	2.5

Documentary Evidences

At Design Stage:

For Option 1, submission of the following:

- Plan or layout showing the site area as well as the greenery that is provided within the development, including a listing of the number of trees, palms, shrubs, turf and the respective sub category and LAI values
- Calculation showing the extent of the greenery provision and derivation of the GnPR

For Option 2, refer to respective sub-indicators under 1.2b Integrated Landscape and Waterscape

Verification (As Built):

For Option 1, submission of the following:

- As-built landscape drawings and delivery orders of the plants
- Re-computation of GnPR for any reduction in greenery from design stage

For Option 2, refer to respective sub-indicators under 1.2b Integrated Landscape and Waterscape

P.2 Residential Envelope and Roof Thermal Transfer

Intent

To reduce air conditioning energy consumption to cool the indoor environment of residential building due to thermal heat gain through the building façade.

Scope

Applicable to all residential buildings.

Assessment

The residential envelope thermal transmittance value (RETV) of the building, as determined in accordance with the formula set out in the “Code on Envelope Thermal Performance for Buildings” issued by the Commissioner of Building Control, shall not exceed the following:

Table P.2 -1 Maximum RETV

Level of Award	RETV
Gold	25W/m ² or lower
Gold ^{PLUS}	22W/m ² or lower
Platinum	20W/m ² or lower

Applicable for all Award levels:

The RETV of west, south-west and north-west facades of all buildings within development should not exceed maximum RETV of 25W/m².

The average thermal transmittance (U-value) for the gross area of the building’s roof shall not exceed the following limits:

Roof Weight Group	Weight Range (kg/m ²)	Maximum U-value (W/m ² K)
Light	< 50	0.8
Medium	50 to 230	1.1
Heavy	> 230	1.5

The roof limits stipulated do not apply to open sided sheds, linkways, covered walkways, store rooms, utility rooms, plant rooms and equipment rooms.

Documentary Evidences

At Design Stage:

Submission of the following:

- RETV and roof U-value calculation
- Architectural elevation drawings showing the composition of the different façade or wall systems that are relevant for the computation of RETV and roof U-value
- Architectural plan layouts and elevations showing all the air-conditioning areas
- Extracts of the tender specification or material schedules showing the material properties of the façade, external walls and roof

Verification (As Built):

Submission of the following:

- Purchase orders/ delivery orders of the façade, roof and external wall system
- As-built material schedules showing the material properties of the façade, roof and external walls
- Revised RETV calculation in the event of any design changes that negatively affect the RETV
- Revised roof U-value calculation in the event of any design changes that negatively affect the roof U-value

P.3 Ventilation Performance

Intent

To encourage the design for effective natural ventilation for thermal comfort, indoor environmental quality for all naturally ventilated spaces.

Scope

Applicable to residential buildings with $GFA \geq 2,000m^2$.

Applicable for the following Award levels:

Platinum

Assessment

The CFD simulations or wind tunnel testing are to be conducted based on the requirements within *Annex A: Computational Fluid Dynamics Simulation Methodology and Requirements* and with reference to sub-indicator 1.3c (i) *Demonstrate Effective Natural Ventilation*.

To be eligible for Green Mark Platinum rating, it is a requirement to use ventilation simulation modelling and analysis or wind tunnel testing to identify the most effective building design and layout. The simulation results and the recommendations derived are to be implemented to ensure good natural ventilation. Projects are given three pathways to comply with:

Step 1

For project that meets the primary evaluation parameters, to conduct decoupled units simulation and a minimum 70% of the selected typical dwelling units should have a weighted average wind velocity of 0.60 m/s

OR

Step 2

For project that cannot meet the primary evaluation parameters, to conduct full scale simulation and a minimum 70% of the selected typical dwelling units should have a weighted average wind velocity of 0.60 m/s;

OR

Step 3

For project that cannot meet step 1 or step 2 but with a minimum 70% of selected typical dwelling units achieving “moderate” natural ventilation (with minimum weighted average wind velocity of 0.2m/s), to comply with the thermal comfort criteria.

Thermal comfort modelling shall be performed based on the following PMV equation and comply with the stated PMV range

$$PMV = -11.7853 + 0.4232T - 0.57889V$$

PMV Range	PPD
-0.5 < PMV < +0.5*	< 10*

where PMV is Predicted Mean Vote
 PPD is Predicted Percentage Dissatisfied
 T is indoor air temperature (°C). Baseline of T is 29.5°C
 V is indoor wind speed (m/s)

Home buyers are allowed to opt out of the scheme, of which developers must include the provision of mechanical aid/ fan into sales & purchase agreement. Such sales & purchase agreement and opt-out agreement must be produced during verification stage.

Other than dwelling units, common areas such as staircases and lobbies (excluding those that are located in basement areas) should also be designed to be naturally ventilated (i.e. to provide openable windows or other openings with aggregate area of not less than 5% of the space required to be ventilated).

Documentary Evidences

At Design Stage:

The ventilation simulation report shall be prepared and submitted in accordance with sub-indicator 1.3c (i) and assessed by a BCA CFD assessor as per requirements for 1.3c (i) *Demonstrate Effective Natural Ventilation*

Verification (As Built):

As per sub-indicator 1.3c (i) *Demonstrate Effective Natural Ventilation*

P.4 Air Tightness and Leakage

Intent

Minimising air infiltration through the building envelope.

Scope

Applicable to all windows and curtain walls on the building envelope.

Assessment

For windows and curtain wall systems, air leakage rates shall not exceed the limit specified in SS 212 – Specification for Aluminium Alloy Windows and SS 381 – Materials and Performance Tests for Aluminium Curtain Walls respectively.

Documentary Evidences

At Design Stage:

Extracts of the tender specification showing compliance to SS212 or SS381 air leakage rates.

Verification (As Built):

Windows and curtain wall systems air leakage rates test report showing compliance to SS212 or SS381.

1.1 Leadership



The long-term sustainability of the built environment, economy and society depends on the collective leadership of building owners in driving sustainable buildings in partnership with the end users of the building. Effective leadership is needed to influence and drive creative, organisational and technical improvements to the overall environmental credentials of projects, from the initial stages of the project through to building occupation and operation. Upstream leadership can push the boundary of projects' fundamental requirements and is the key towards shifting the needle towards climatic responsive design. This is supported by an integrated design process that resonates among the stakeholders, a strong design team and a shared vision of building a sustainable development and how the vision could be achieved.

Criteria	Points
1.1a Climatic & Contextually Responsive Brief	1
1.1b Integrative Design Process	2
1.1c Environmental Credentials of Project Team	2
1.1d Building Information Modelling	2
1.1e User Engagement	1
TOTAL	8
Advanced Green Efforts	3

1.1a Climatic & Contextually Responsive Brief

Intent

Conceptualization of clear environmental sustainability targets and design approaches early at the onset of the project.

Scope

Applicable to all residential buildings

Assessment

Criteria	Points
Climatic & Culturally Responsive Brief	1

Demonstration of the above process through two parts:

Strategic Definition – Preliminary definition of the client’s sustainable aspirations for the project and identification of its green potential benchmarked against similar projects. Feasibility studies involving assessments of options against functional requirements and potential constraints should be prepared to rationalise the brief.

Preparation and Brief – Setting of agreed achievable formal sustainability targets for the project. In addition to the project’s targeted Green Mark rating, such targets should involve specific sustainable outcomes and indicators. The selection, deployment and responsibilities of the project team, builders and building operators in order to ensure an optimised building should be detailed as well. This includes the identification of at least one member of the project team to take the lead in coordinating sustainability efforts and tracking of the targets throughout the building design, construction and handover phase

Documentary Evidences

At Design Stage:

Submission of written statements, reports, documents, correspondences and notes of discussion demonstrating the particular project’s briefing process, endorsed by the client or client’s representative and acknowledged by the key project team members.

1.1b Integrative Design Process

Intent

Develop collaborative framework for the project team during the briefing, concept design and technical design phase to address the various needs of all stakeholders to achieve the common targets results in a more balanced and optimized design outcome.

Scope

Applicable to all residential buildings.

Assessment

Criteria	Points
Integrative Design Process	2

Demonstration of the above process through:

- Appointment of all relevant consultants early in the design phase
- Identification of responsible parties within the team to implement sustainability goals and targets
- Detailing of sustainable design methodology action plans and progress
- Addressing of opportunities and challenges with integrative team strategies to achieve the targets
- Organising of design charrettes at key stages within the project design

Definitions

Design charrette: A collaborative meeting for design and planning. The aim of design charrettes is for the team to jointly set and review sustainability targets, progress and outcomes. They serve as platforms for the various disciplines within the project team to voice opportunities to optimise design, and for the team to work together to evaluate the opportunities against other constraints.

Documentary Evidences

At Design Stage:

- Reports, documents, correspondences and notes of discussions at the various project stages demonstrating the integrative design process
- Evidences of the implementation of design optimisation arising from the charrettes discussions

1.1c Environmental Credentials of Project Team

Intent

This pertains to the appointment of environmental specialists at building design, construction and operation stages.

Scope

Applicable to all residential buildings.

Assessment

Criteria	Points
Green Individuals	0.5
Green and Gracious Builder	0.5
Green Companies	1.5
	<i>Cap at 2 points</i>

Green Individuals:

0.25 points shall be awarded for a Green Mark Accredited Professional (GM AP) or Green Mark Accredited Facilities Professional (GM AP (FM)).

0.5 points shall be awarded for a Green Mark Advanced Accredited Professional (GM AAP) or Green Mark Advanced Accredited Facilities Professional (GM AAP (FM)).

Green and Gracious Builder:

Up to 0.5 point shall be awarded where the main builder is a BCA certified Green and Gracious Builder. 0.25 point for Certified and Merit or 0.5 point for Excellent and Star rating

Green Companies:

0.5 point shall be awarded where at least 3 of the following are ISO 14001 certified: Architect, M&E Engineer, C&S Engineer, Developer and Main Contractor.

0.5 point shall be awarded for each SGBC Green Services Certified firm.

Documentary Evidences**At Design Stage:**

- Certified true copy of the certificate of Green Mark Accredited Professional (GM AP)/ Green Mark Accredited Facilities Professional (GM AP (FM))/ Green Mark Advanced Accredited Professional (GM AAP)/ Green Mark Advanced Accredited Facilities Professional (GM AAP (FM)) where applicable and a confirmation of their involvement and contribution in the project
- Certified true copy of the main builder's Green and Gracious Builder award
- Certified true copy of the ISO 14000 certificate of developer, main contractor, M&E consultant, C&S engineer and architect where applicable
- Extracts of SGBC certified companies from SGBC website

Worked Example

A project has the following members in its project team.

- A certified Green Mark Accredited Professional who is actively involved in leading the sustainable design process during throughout the various project stages (0.25 point)
- BCA certified Green and Gracious Builder (Star level) (0.5 point)
- The Architect and Developer are ISO 14001 certified (0.5 point)
- The Architect and M&E Engineer are SGBC Certified companies (0.5 point)

Therefore, points scored for 1.1c = 1.75 points

1.1d Building Information Modelling (BIM)

Intent

BIM can be used as a tool for coordination and design integration, enabling optimisation of resources and downstream building performance.

Scope

Applicable to all building developments.

Assessment

Criteria	Points
Use of BIM for clash detection purposes	1
Use of BIM for environmental analysis and building performance simulation	1
<i>SMART BIM (Advanced Green Efforts)</i>	<i>3</i>

BIM

Also referred to as social BIM or collaborative BIM, integrative BIM refers to the use of a coordinated BIM modelling framework that harmonises the various disciplines' designs in a 3D environment, to facilitate the co-ordinated spatial design and reduce clashes during construction. Integrative BIM models can also be used to form the base models for various building performance simulations, the results of which can be used to further optimise the building design. Many performance plug-ins are being developed that can evaluate building energy use, façade heat gains and ETTV, lighting and daylighting analysis, as well as natural ventilation performance.

Assessment

1 point for the coordinated use of BIM between the involved parties in the construction value chain. Minimally comprising of the Architect, the MEP Engineers and the Structural Engineer.

1 point for the use of BIM for environmental analysis, building performance simulation and clash detection purposes.

Documentary Evidences

At Design Stage:

Submission of the following where applicable:

- Collaborative BIM: BIM Execution Plan showing evidence of BIM Collaboration requirements, and coordinated BIM models of the Architectural, Structural and MEP (Mechanical, Electrical and Plumbing) disciplines
- Green BIM: BIM Execution Plan showing evidence of Green BIM requirements, details of the analysis software/ performance plugins used, processes and how this has been employed to evaluate and optimise the building design in areas such as (but not limited to) building energy use, façade heat gains and ETTV, lighting and daylighting analysis, as well as natural ventilation performance etc.

SMART BIM (Advanced Green Efforts)

Smart BIM comprises of 3 levels:

1. 4D (Time) BIM – This links time information to the BIM model for project scheduling and coordination. By reflecting real time construction activity on site, the 4D model can be used to review progress against the construction programme and identify methods to assess delays, make up time and evaluate extensions of time (EOT) claims.
2. 5D (Cost) BIM – This consists of elemental details, finishes, fixtures and equipment within the model linked to data on performance, manufacturers and specifications. The 5D model can assist in the preparation of cost and quantity schedules and tracking of the project budget. The use of integrated scheduling tools can be incorporated including those tailor made for Singapore such as SIA Idol and INPQS.
3. Use BIM software to undertake green mark CUI calculation.

Assessment

1 point each for 4D (Time) BIM, 5D (Cost) BIM or BIM for CUI calculation

Documentary Evidences

At Design Stage:

Submission of the following where applicable:

- 4D/5D model
- Relevant project-specific procedural documents and specifications evidencing linking of relevant elemental attributes to the BIM model and how they are/will be used to optimise processes

1.1e User Engagement

Intent

This refers to the provision of relevant information and guidance to building occupants as to how they can contribute positively to the reduction of the building's environmental impact.

Scope

Applicable to all residential buildings.

Assessment

Criteria	Points
Building User Guide with Green Fit-out Guidelines	1

1 point shall be provided for building user guide with `green fit out guidelines disseminated to all relevant occupant/management personnel in the building. The guide should provide a detailed overview of the sustainable design strategies and all green features employed in the building and how they benefit the user, with an emphasis on occupant health and well-being. It should include clear O&M instructions related to the green features, written in a way the users can understand and also assist them in making sustainable fit-out decisions. The information detailed in Table 1.1e-1 in the subsequent page should not be excluded from the guide.

Documentary Evidences

At Design Stage:

Submission of the following where applicable:

- Building user guide with green fit-out guidelines prepared and endorsed by the client representative, complete with commitment that they will be circulated as specified above

Verification (As Built):

Submission of the following where applicable:

- Official building user guide with green fit-out guidelines for circulation, and evidence of their circulation to the respective parties

Table 1.1e-1: Recommended Information to be included in the Building User Guide

Introduction – an overview of the design, the passive and environmental strategies employed and how they benefit the user.

Energy

- i) Details of the low energy lighting fittings and their operational controls
- ii) Details of energy labelling for any supplementary equipment and advice on selection
- iii) Details on how to track energy consumption

Water

- i) Information on WELS rated products including water fittings and water efficient system adopted
- ii) Details on water saving measures and tips

Waste & Recycling

- i) Information on the waste collection strategies
- ii) Information on waste recycling practices

Green Transportation and Access

- i) Details of bicycle parking provisions
- ii) Details of the local transportation options to and from the building

Local Amenities

- i) Details of the amenities and facilities within and around the building

Responsible & Healthy Fit Out

- i) Details of the green products used within the building
- ii) Importance of using green fit-out and low VOC materials
- iii) Embodied energy of building materials selection

Responsible Purchasing

- i) Advice on green procurement strategies relevant to the type of building occupant

Others

- i) The environmental impact of user behaviour
- ii) Information on good practices for sustainable building operations relevant to the building users including links to websites, publications and organisations providing information or guidance on environmentally sound operations, environmental tips and initiatives.

1.2 Urban Harmony



With buildings forming part of a larger urban environment, it is important to identify the impact of the physical form of a building, which prefixes its sustainable performance, with respect to its immediate locale and larger context. Designing for a building's human-centricity looks at how its presence can co-exist in harmony with its surrounding context and positively impact the movement and comfort of the people in its neighbourhood.

Criteria	Points
1.2a Sustainable Urbanism	5
1.2b Integrated Landscape and Waterscape	5
TOTAL	10

1.2a Sustainable Urbanism

Intent

Through site analysis and mitigation measures, a sustainable accessible and contextual response can be developed to ensure that the development enhances the urban realm as well as minimises its environmental impact and dis-amenity to the surrounding buildings.

Scope

Applicable to all residential buildings.

Assessment

A maximum cap of 5 points can be scored under the following sub-criteria:

Criteria	Points
(i) Environmental Analysis	2
(ii) Response to Site Context	3
(iii) Urban Heat Island	1
(iv) Green Transport	1
	<i>Cap at 5 points</i>

1.2a (i) Environmental Analysis

A study/ assessment to be conducted prior to the commencement of activities on-site to identify the anticipated effects on climate change, flora and fauna, soil, air and water that the development may have. It should identify and implement measures to mitigate any adverse impacts, protect valuable site ecology and/ or to improve the site to its original condition.

Assessment

A maximum cap of 2 points can be scored under the following sub-criteria:

1 point shall be awarded for an environmental study.

2 points shall be awarded for a comprehensive Environmental Impact Assessment (EIA).

Documentary Evidences

At Design Stage:

Submission of an environmental study report, or an Environmental Impact Assessment (EIA), acknowledged by the client or client representative. The EIA shall be conducted by a competent specialist. The environmental study report shall not necessarily be used to fulfil authority requirements. The report/ EIA should detail:

- The proposed development and its need
- The existing environment of the site
- The impacts of the proposed development and its alternatives on the environment, minimally covering the aspects of climate change, flora and fauna, soil, air and water where applicable

- Recommendations and measures to mitigate any adverse impacts and/ or opportunities to improve the site beyond its original condition before the development, i.e. how the ecological features or areas of the site are to be adequately protected from damage or disturbance during the construction activities from site clearance and preparation through to practical completion and handover. (Note: Replacement is not able to be considered as mitigating measures for features of identified value removed in the construction process or site clearance.)
- A non-technical summary

At Verification Stage:

Submission of the following:

- Documentary/ photographic evidences of the committed environmental mitigation measures implemented during the construction and initial occupancy of the development.

1.2a (ii) Response to Site Context

A site analysis identifies the relationships between the human and physical geography of the site. It should consider how the urban context, site topography and hydrology, site micro climate, site access and connectivity can inform the design of the urban form and site layout to respond accordingly.

Assessment

A maximum cap of 3 points can be scored under the following sub-criteria:

1 point shall be awarded for Level 1 site analysis and design that demonstrates sensitivity to the site condition.

3 points shall be awarded for Level 2 analysis optimised design via iterative simulations.

Guidance Notes

An outline of the site analysis report is as follows:

- Executive summary – A non-technical summary that summarises the site analysis
- Urban context – The urban form, land use and its impact on the site
- Site topography & hydrology – Land and topographical survey of the site facilitating design decisions based on the site's topographical features, stormwater runoff and other key features. This section can link to the EIA under 1.2a(i) if conducted
- Site microclimate – Sun/ wind/ acoustics/ views/ air quality
 - Level 1: Identification on plan and photographic evidences of the key microclimatic conditions of the site and how this will be considered in the design
 - Level 2: Macro level simulations that analyse the site context
- Site access and connectivity – Details of pedestrian and vehicular traffic, site accessibility and public transport options. The analysis shall investigate the connectivity potential to connect the site to existing green infrastructure such as parks, gardens or cycle routes, as well as sheltered connectivity to public transport.
 - Level 1: Concept design studies demonstrating how the functional requirements of the project responds positively to the site context including enhancing site access

- Level 2: Iterative massing studies through macro simulations that identify how the urban form of the building has been optimised, including outdoor thermal comfort analysis. The simulations should identify that the building minimises its impact on its neighbours.

Documentary Evidences

At Design Stage:

Submission of the following:

- Level 1/ Level 2 site analysis report

1.2a (iii) Urban Heat Island

By demonstrating measures to mitigate the urban heat island effect through the material selection of the hardscape, softscape and building surfaces.

Assessment

A maximum cap of 1 point can be scored under the following sub-criteria:

% Site coverage (at plan view)	Points
≥ 50% demonstrating mitigation measures	0.5
≥ 80% demonstrating mitigation measures	1

Guidance Notes

The site plan shall be used to calculate the site coverage of the UHI mitigation measures such as:

- Green and blue spaces for landscaping and roof
- Roofing materials or coatings or cool paints with high Solar Reflectance Index (SRI) > 40
- Unshaded hardscape areas with SRI > 39, inclusive of unshaded car parks, internal roads and footpaths
- Use of permeable paving strategies such as gravel or open paving systems
- Other performance based strategies that demonstrate UHI effect mitigation

Areas with renewable energy (photovoltaic panels) shall be deemed to comply.

Documentary Evidences

At Design Stage:

Submission of the following where applicable:

- Site plan highlighting vegetation, waterbodies, hardscape and roof areas
- Calculation of hardscape areas shaded by vegetation based on a midday sun i.e. the shadow shall correspond to the area directly under the tree canopies. The tree canopy size shall be based on the mature crown size as per NParks guidelines (also referenced under 1.2c(i))

- Material schedules or specifications of the roof and hardscape finishes with corresponding SRI values. Where such values are not provided, calculations in accordance to *ASTM E1980 – 11* may be used, supported by solar reflectance and thermal emittance specifications.

Verification (As Built):

Submission of the following where applicable:

- Any design changes to be highlighted on the plan drawing and the areas recalculated
- Photographic evidences of the vegetated areas
- Delivery orders of the hardscape materials and roof finishes supported by technical specifications providing the SRI or solar reflectance and thermal emittance values

1.2a (iv) Green Transport

Intent

To reduce the emissions from vehicular transport through the promotion of electric vehicles and bicycle lots.

Assessment

A maximum cap of 1 point can be scored under the following sub-criteria:

0.5 point shall be awarded for the provision of electrical vehicle charging and parking infrastructure; at least 1 lot per 100 lots (cap at 5 lots)

1 point shall be awarded for the provision of sheltered bicycle lots, in-line with LTA's quantity requirement

Documentary Evidences

At Design Stage:

Submission of the following:

- Electric vehicle charging infrastructure
 - Extracts of the tender specifications showing the requirement to provide electric vehicle charging and parking infrastructure
 - Plans indicating the location, number and provision of electric vehicle charging and parking infrastructure
- Sheltered bicycle lots
 - The location and number of sheltered bicycle lots, in-line with LTA's quantity requirement

Verification (As Built):

Submission of the following:

- As-built drawings and photographs highlighting the provision of the committed features

1.2b Integrated Landscape and Waterscape

Intent

Projects are encouraged to integrate a verdant landscape and waterscape into their building design to enhance the biodiversity around the development and provide visual relief to building occupants and neighbours.

Assessment

A maximum cap of 5 points can be scored under the following sub-criteria:

Criteria	Points
(i) Green Plot Ratio (GnPR)	3
(ii) Tree Conservation	1
(iii) Sustainable Landscape Management	1
(iv) Sustainable Stormwater Management	1
	<i>Cap at 5 points</i>

1.2b (i) Green Plot Ratio (GnPR)

The provision of greenery for the development can be quantified via the Green Plot Ratio (GnPR).

Assessment

GnPR	Points Allocation
2.5 to < 3.0	1.0
3.0 to < 3.5	1.5
3.5 to < 4.0	2.0
4.0 to < 4.5	2.5
≥ 4.5	3.0

Guidance Notes

The LAI of the individual plant species and its canopy area are predetermined design parameters as listed below:

Plant Group	Trees	Palms	Shrubs & Groundcover	Turf
Leaf Area Index (LAI)	Open Canopy = 2.5 Intermediate Canopy = 3.0 Dense Canopy = 4.0	Solitary = 2.5 Cluster = 4.0	Monocot = 3.5 Dicot = 4.5	2.0
Fixed Area*:	Columnar = 12m ² Non Columnar = 60m ²	Solitary = 20m ² Cluster = 17m ²	Planted Area	Planted Area
Note: Exceptions apply to trees or palms planted at ≤ 2.0m centre trunk to trunk/ columnar trees as elaborated further.				

The plant species sub categories and LAI values can be obtained from the online website: <http://florafaunaweb.nparks.gov.sg> by searching the common/ scientific names of the plants.

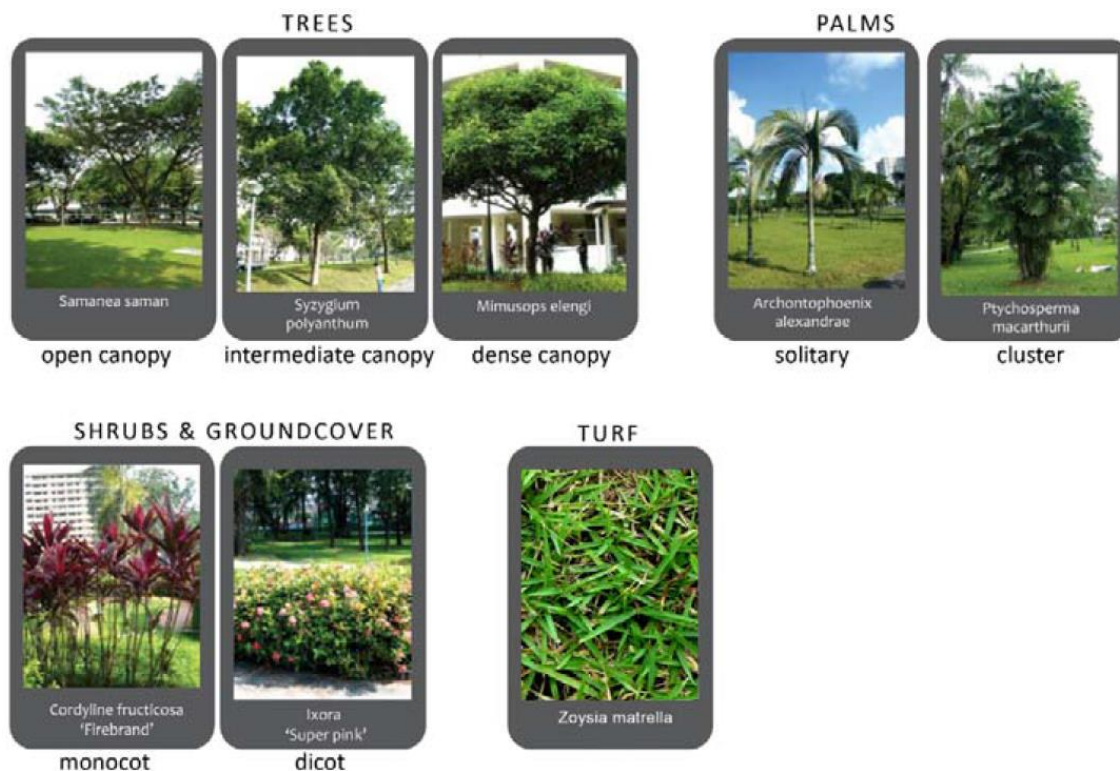

Trees and palms spacing (centre-to-centre): If the selected trees and palms are to be planted at $\leq 2\text{m}$ from trunk-to-trunk as illustrated below, the leaf area shall be calculated as the product of LAI value and planted area.

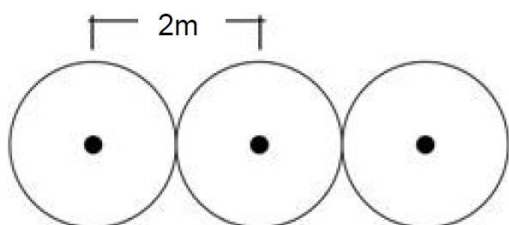

Columnar trees: For trees that have tight, columnar crowns, the canopy area of 12 m^2 is to be adopted for calculation of leaf area. These species include (but not limited to) the following:

- *Garcinia Cymosa Forma Pendula*
- *Garcinia Subelliptica*
- *Polyalthia Longifolia*
- *Carallia Brachiate*
- *Gnetum Gnemon*

Documentary Evidences

At Design Stage:

Submission of the following:

- Plan or layout showing the site area as well as the greenery that is provided within the development, including a listing of the number of trees, palms, shrubs, turf and the respective sub category and LAI values
- Calculation showing the extent of the greenery provision and derivation of the GnPR

Verification (As Built):

- As-built landscape drawings and delivery orders of the plants
- Re-computation of GnPR for any reduction in greenery from design stage

Worked Example

Determine the number of trees, palms and the areas for shrubs and turfs and other greenery areas. Then compute the green areas. The table below is shown as an example:

Category	Sub category	(A)	(B)	(C)	(A) x (B) x (C)
		LAI value	Canopy Area	Qty/ Planted Area	Leaf Area
Trees (no.)	Open Canopy	2.5	60 m ²	0 no.	0 m ²
	Intermediate Canopy	3.0	60 m ²	8 no.	1440 m ²
	Dense Canopy	4.0	60 m ²	12 no.	2880 m ²
	Intermediate columnar canopy	3.0	12 m ²	4 no.	144 m ²
Palms (no. or m ²)	Solitary	2.5	30 m ²	10 no.	750 m ²
	Solitary (trunk-to trunk ≤ 2m)	2.5	NA	20 m ²	50 m ²
	Cluster	4.0	17 m ²	10 no.	680 m ²
Shrubs (m ²)	Monocot	3.5	NA	0 m ²	0 m ²
	Dicot	4.5	NA	20 m ²	90 m ²
Turf (m ²)	Turf	2.0	NA	90 m ²	180 m ²
Vertical Greenery (m ²)	-	2.0	NA	10 m ²	20 m ²
Total Leaf Area :					6,234 m ²

Assuming the site area is 2,000m²,

Green Plot Ratio (GnPR) = Total leaf area / site area = 6,234 / 2,000 = 3.117

Therefore, points scored for 1.2b (i) = 1.5 points

1.2b (ii) Tree Conservation

To encourage preservation of existing trees on-site to prevent disturbance to established habitats. Where trees are felled, the project team is encouraged to replant an equivalent number of similar species of equivalent LAI.

Assessment

Tree Conservation	Points
Preservation of Existing Trees	0.5
Replant an equivalent number of similar species of equivalent LAI	0.5

Documentary Evidences

At Design Stage:

Submission of the following:

- Site layouts showing the exiting and final locations (where applicable) and number of the trees to be restored, conserved or relocated
- Existing site plans showing the location and numbers of trees that are to be felled with the identification of the tree species and LAI values. The proposed landscape plans shall show the proposed equivalent number and tree species with LAI values of the replacement trees

Verification (As Built):

Submission of the following:

- As built drawings, transplanting records and on site photographs of the conserved trees
- As built drawings and photographs of the replaced trees

1.2b (iii) Sustainable Landscape Management

To ensure the landscape enhances the biodiversity through effective sustainable management of the landscape of a development.

Assessment

A maximum cap of 1 point can be scored under the following sub-criteria:

1 point shall be awarded for projects certified under NParks Landscape Excellence Assessment Framework (LEAF) certification.

For projects not certified under LEAF, 0.5 point each can be scored for the following:

- The adoption of native species of greenery > 50% of the flora selected wherever possible to maintain the local ecosystem
- A landscape management plan established that covers:
 - The use of organic composts from horticultural wastes
 - The potential for on-site composting
 - General landscape maintenance and management plan during building occupation

Documentary Evidences

At Design Stage:

Submission of the following where applicable:

- LEAF certification: Extracts of the tender, or a signed commitment from the developer/ building owner that NParks LEAF certification will be applied for
- Adoption of native species: Landscape plan outlining the native species with a calculation of the % of site coverage
- Landscape management plan: Draft landscape management plan with supporting tender specifications

Verification (As Built):

Submission of the following where applicable:

- LEAF certification: Letter of Award or LEAF certificate
- Adoption of native species: Delivery orders of the native species and quantity to be prepared and submitted. Any variations would require a re-tabulation
- Landscape management plan: The completed landscape management plan and implementation records supported by photographic evidences, delivery orders of composts with reports of soil/ compost mixes as well as the landscape maintenance manual

1.2b (iv) Sustainable Storm Water Management

To reduce storm surges and to improve the quality of water entering the public drains through infiltration or design features.

Assessment

A maximum cap of 1 point can be scored under the following sub-criteria:

Sustainable Storm water Management	Points
PUB Active, Beautiful and Clean Waters (ABC Waters) certification	1
OR	
Treatment of storm water run-off through the provision of infiltration or design features before discharge to the public drains	
(i) Treatment of $\geq 10\%$ of run off from total site area	0.5
PUB ABC Waters 'Gold Class' Certification (Advanced Green Efforts)	1

Documentary Evidences

At Design Stage:

Submission of the following where applicable:

- PUB ABC Waters Certification: PUB ABC Waters Certificate
- Provision of infiltration or design features:

- Design calculation that shows the % of site area that is drained to the infiltration or design features for treatment, with endorsement of an ABC Waters Professional
- Location plan of the relevant infiltration or design features

Verification (As Built):

Submission of the following where applicable:

- Provision of infiltration or design features:
 - Final set of design calculation that shows the % of site area that is drained to the infiltration or design features for treatment, with endorsement of an ABC Waters Professional
 - Declaration of an ABC Waters Professional on the % of site area that is drained to the completed infiltration or design features for treatment

5.1b Sustainable Stormwater Management (Advanced Green Efforts)

To reduce storm surges and to improve the quality of water entering the public drains through infiltration or design features.

Assessment

1 point shall be awarded for projects that attained 'Gold Class' rating under the PUB Active, Beautiful and Clean Waters (ABC Waters) certification

Documentary Evidences

Design Stage:

Submission of the following:

- PUB ABC Waters Certification: PUB ABC Waters 'Gold Class' Certificate

1.3 Tropicality



Shaping building passive design in consideration of the climatic context, including its orientation, facades as well as interior layout can reduce the building’s heat load and energy usage and enhance effective thermal comfort for its occupants. From a performance point of view, buildings should be highly permeable in areas of natural ventilation and at the same time be shielded against heat ingress.

Criteria	Points
1.3a Tropical Façade Performance	5
1.3b Internal Organisation	2
1.3c Ventilation Performance	10
TOTAL	17
Advanced Green Efforts	5

1.3a Tropical Façade Performance

Intent

A responsive tropical façade is one that reduces the heat gain into the building, providing perceptible comfort through reducing the direct sunlight into the building.

Scope

Applicable to all residential buildings.

Assessment

Criteria	Points
Tropical Façade Performance	5
<i>Vertical Greenery on the East and West Facade (Advanced Green Efforts)</i>	2
<i>Use of thermal insulation or cool paints on the east and west facing external walls (Advanced Green Efforts)</i>	1
<i>Façade Design Strategies (Advanced Green Efforts)</i>	2

Up to 5 points can be scored for building envelope with better thermal performance than the baseline standard:

1 point for every reduction of 1 W/m² in RETV from the baseline.

Points scored = 25 - (RETV) where RETV ≤ 25 W/m²

Where RETV stands for Residential Envelope Transmittance Value.

The computation of RETV shall be based on the methodology specified in the Code on Envelope Thermal Performance for Building issued by BCA.

For developments consisting of more than one residential building, the weighted average of the RETVs based on the façade areas of these buildings shall be used as the basis for point allocation.

This is $RET_{V \text{ weighted average}} = \frac{\sum (RET_{V \text{ bldg}} \times A_{\text{bldg}})}{A_{\text{devt}}}$

where

$RET_{V \text{ bldg}}$ = RETV for a residential building (W/m²)

A_{bldg} = Summation of all facade areas that enclose all living rooms, dining rooms, study rooms and bedrooms of a residential building (m²)

A_{devt} = Summation of total applicable facade areas of all residential buildings within the development (m²) (i.e. $\sum A_{\text{bldg}}$)

Vertical greenery system on building facades abutting the living rooms, dining areas and bedrooms of dwelling units (Advanced Green Efforts)

- a. 2 for more than 50% of building facades
- b. 1 for at least 25% of building facades

Use of thermal insulation or cool paints on the east and west facing external walls

- a. 1 point for window to wall ratio (WWR) of less than 0.5
- b. 0.5 point for WWR that is between 0.5 to 0.8

To encourage façade design that improve thermal comfort of dwelling units (Advanced Green Efforts). Up to 2 points shall be awarded for the following design:

- For development with WWR ≤ 0.5 and at least 70% of units with cross ventilation and facing north and/or south (1pt)
- Use monsoon windows that allow the outdoor air to flow into indoors without rain (1pt)
- For development with gable walls designed with better thermal insulation (e.g. a layer of air gap, polystyrene, etc.) (1pt)

Note

PS form is not recommended as the wall insulation material in the façade with windows as it may inhibits the heat transfer from indoor to outdoor environments, when window is closed.

Documentary Evidences

The RETV pre-requisite must be met for the level of award that the project is targeting. This will also be verified at the as built stage.

At Design Stage:

Submission of the following:

- RETV calculation
- Architectural elevation drawings showing the composition of the different façade or wall systems that are relevant for the computation of RETV
- Architectural plan layouts and elevations showing all the air-conditioning areas
- Extracts of the tender specification or material schedules showing the material properties of the façade and external walls

Verification (As Built):

Submission of the following:

- Purchase orders/ delivery orders of the façade and external wall system
- As-built material schedules showing the material properties of the façade and external walls
- Revised RETV calculation in the event of any design changes that negatively affect the RETV

Worked Example

Example 1

$$\text{RETV} = 22 \text{ W/m}^2$$

$$\text{Points scored} = 25 - (\text{RETV}) = 25 - (22) = 3 \text{ points}$$

Example 2

$$\text{RETV} = 19 \text{ W/m}^2$$

$$\text{Points scored} = 25 - (\text{RETV}) = 25 - (19) = 6 \text{ points} > 5 \text{ points (max)}$$

Therefore, points scored should be 5 points (Max)

Example 3

A proposed building development comprises three residential building blocks. The individual RETV of the each residential building computed are as follows:

$$\begin{array}{ll} \text{RETV}_{\text{bldg1}} = 20 \text{ W/m}^2 & A_{\text{bldg}} = 4000 \text{ m}^2 \\ \text{RETV}_{\text{bldg2}} = 25 \text{ W/m}^2 & A_{\text{bldg}} = 3600 \text{ m}^2 \\ \text{RETV}_{\text{bldg3}} = 19 \text{ W/m}^2 & A_{\text{bldg}} = 5000 \text{ m}^2 \end{array} \left. \vphantom{\begin{array}{l} \\ \\ \end{array}} \right\} \begin{array}{l} A_{\text{devt}} = 4000 + 3600 + 5000 \\ = 12600 \text{ m}^2 \end{array}$$

Therefore

$$\begin{aligned} \text{RETV}_{\text{average}}^{\text{Weighted}} &= \frac{\sum (\text{RETV}_{\text{bldg}} \times A_{\text{bldg}})}{A_{\text{devt}}} \\ &= \frac{(\text{RETV}_{\text{bldg1}} \times A_{\text{bldg1}}) + (\text{RETV}_{\text{bldg2}} \times A_{\text{bldg2}}) + (\text{RETV}_{\text{bldg3}} \times A_{\text{bldg3}})}{(A_{\text{devt}})} \\ &= \frac{(20 \times 4000) + (25 \times 3600) + (19 \times 5000)}{12600} \\ &= 21.03 \text{ W/m}^2 \end{aligned}$$

$$\text{Points scored} = 25 - (\text{RETV}) = 25 - (21.03) = 3.97 \text{ points}$$

Note: Refer to the Code on Envelope Thermal Performance for Buildings for more detailed examples on how to compute the RETV.

1.3b Internal Organisation

Intent

The internal spatial organisation of a building provides opportunities to improve the operational efficiency of the building over its entire life. Strategic decision-making including the location of transient spaces have lasting effects on the building's performance.

Scope

Applicable to all residential buildings.

Assessment

Criteria	Points
Transient spaces to be passively designed	2

1 point shall be scored if at least 80% of the lift lobbies (including private lift lobbies) and corridors areas are designed to be naturally ventilated.

1 point shall be scored if at least 80% of the staircases areas are designed to be naturally ventilated.

Documentary Evidences

At Design Stage:

Submission of the following where applicable:

- Plans and details of the common spaces including façade openings and ventilation modes

Verification (As Built):

Submission of as built drawings of the approved spaces

Worked Example

Proposed development has the following provision:

All lift lobbies and corridors are designed to be naturally ventilated except for two private lobbies of the penthouses units which are designed with air-conditioning system. All staircases are designed to be naturally ventilated

No point for lift lobbies if less than 80% of lift lobbies are naturally ventilated.

1 point for staircases that are all designed to be naturally ventilated.

Therefore, points scored for 1.3b = 1 point

1.3c Ventilation Performance

Intent

Enhance building design to achieve good natural ventilation for better indoor comfort and healthy for the building occupants.

Scope

Applicable to all residential buildings.

Assessment

Criteria	Points
Demonstrate Effective Natural Ventilation	10
<i>Passive Design Strategies (Advanced Green Efforts)</i>	3
<i>Wind Driven Rain Simulation (Advanced Green Efforts)</i>	2

1.3c (i) Demonstrate Effective Natural Ventilation (By Simulation & Modelling)

To encourage the design for effective natural ventilation for thermal comfort, indoor environmental quality for all dwelling units.

Assessment

Points shall be awarded based through the following pathway (capped at 10 points):

Criteria (Either one)	Points
Step 1 Ventilation Simulation Modelling + 1.3c (ii)	10 points
Step 2 Ventilation Simulation Modelling	10 points
Step 3 Thermal Comfort Modelling + 1.3c (ii)	8 points

The CFD simulations or wind tunnel testing are to be conducted based on the requirements in the Annex A: Computational Fluid Dynamics Simulation Methodology and Requirements.

To be eligible for Green Mark Platinum rating, it is a requirement to use ventilation simulation modelling and analysis or wind tunnel testing to identify the most effective building design and layout. The simulation results and the recommendations derived are to be implemented to ensure good natural ventilation. Projects are given the following pathways to comply with the requirement:

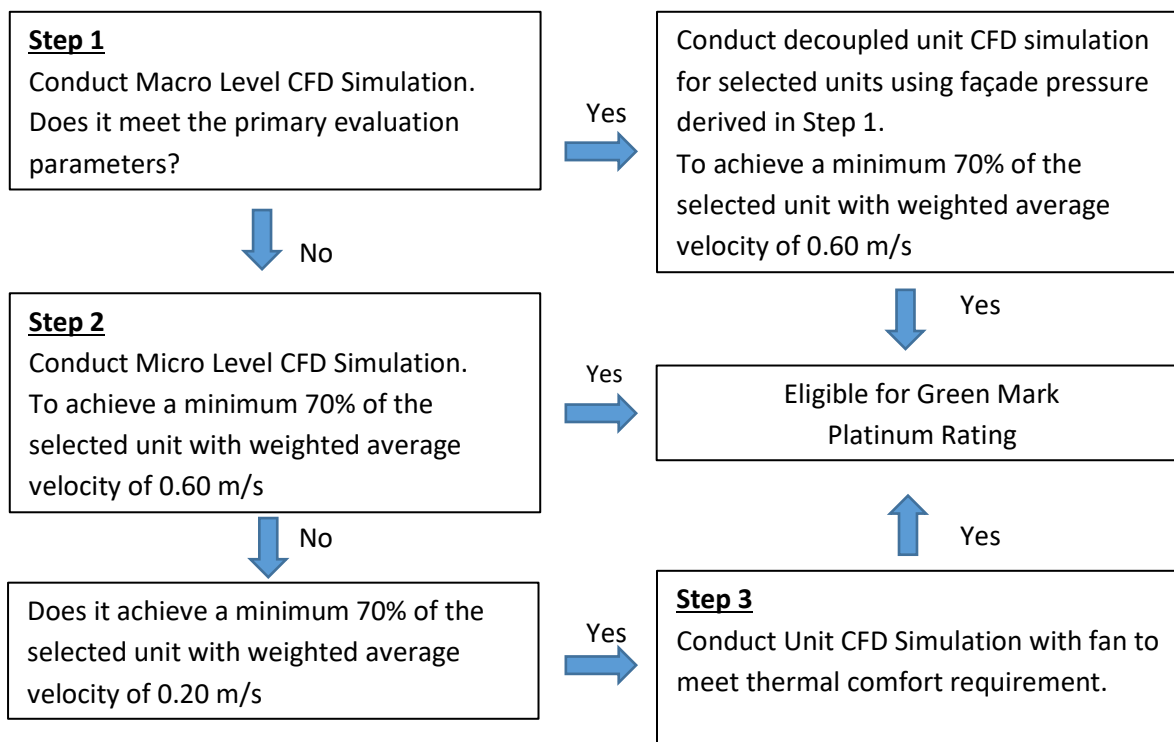

Step 1- Ventilation Simulation Modelling

3 points if the development has good natural ventilation if a minimum 70% of the selected units with minimum weighted average wind velocity of 0.60m/s.

Step 2 – Ventilation Simulation Modelling

Points scored = (% of selected typical units with good natural ventilation)/7 **(up to 10 points)**

Note:

Development scoring for 1.3c (i) Step 2- Ventilation Simulation Modelling is not eligible to score under 1.3c (ii)

Step 3 – Thermal Comfort Modelling

1 point if the development complies with the thermal comfort criteria

Documentary Evidences

Design Stage:

Ventilation Simulation

The CFD simulations or wind tunnel testing are to be conducted based on the requirements in the Annex A: Computational Fluid Dynamics Simulation Methodology and Requirements.

Ventilation simulation or wind tunnel testing reports summarising the analysis and modelling results for each typical space as well as the recommendations for design. Calculation showing the percentage of units achieving good natural ventilation.

Or

Thermal Comfort Modelling

The simulation results and the recommendations derived are to be implemented to ensure optimised natural ventilation to the Moderate level as stated in the Annex A: Computational Fluid Dynamics Simulation Methodology and Requirements. The project team can further demonstrate meeting the thermal comfort criteria through mechanically assisted ventilation.

1.3c (ii) Demonstrate Effective Natural Ventilation (By layout and unit design)

Enhance building design to achieve good natural ventilation for better indoor comfort through effective building layout and unit design

Assessment

Up to 7 points can be scored for designing the following air flow within dwelling units

- Building layout design that utilises prevailing wind conditions to achieve adequate cross ventilation.

0.5 point for every 10% of units with window openings facing north and south directions

- Dwelling unit design that allows for true cross ventilation in the living rooms and bedrooms of the dwelling units

0.5 point for every 10% of living rooms and bedrooms design with true cross ventilation

Note:

Development scoring for 1.3c (i) Ventilation Simulation Option 2 is not eligible to score under 1.3c (ii)

Guidance Notes

In Singapore, the prevailing wind comes from two predominant directions; that is the north to north-east during the Northeast monsoon season and south to south-east during the South-west monsoon season. Hence, buildings designed with window openings facing the north and south directions have the advantage of the prevailing wind conditions which would enhance indoor thermal comfort. Meteorological data on the more precise wind direction and velocity of the site location can also be used as the basis for the design.

It is not necessary for the window openings to be located perpendicularly to the prevailing wind direction. An oblique angle is considered acceptable (see illustrations next page).

Illustrations on building layout design that facilitate cross ventilation

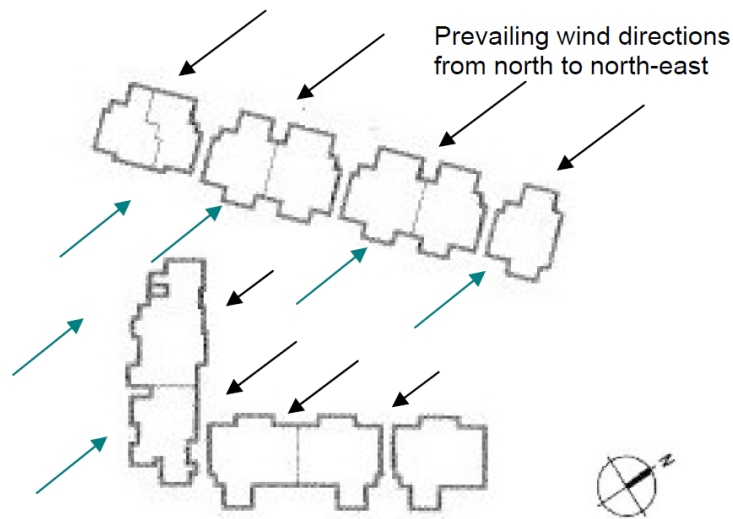

Prevailing wind directions from south to south-east

Illustration 1 – Building layout showing all dwelling units with window openings facing the north and south direction. In this instance, all units can be considered meeting the requirement 1.3c (ii) on building layout design that utilises prevailing wind conditions to achieve adequate cross ventilation.

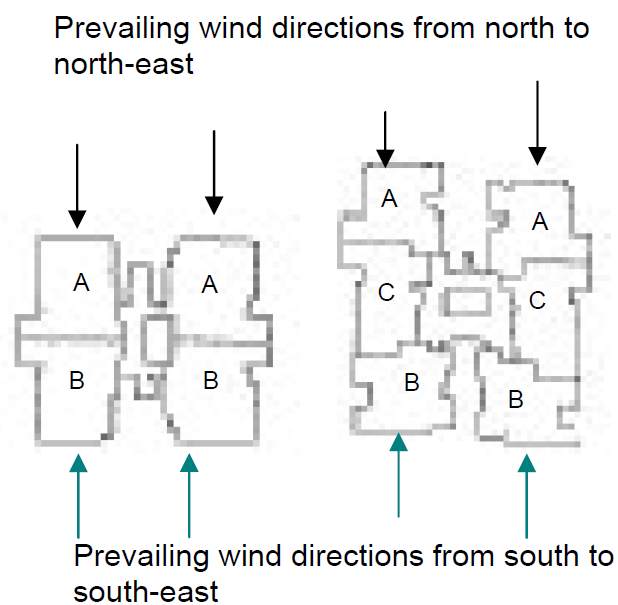

Illustration 2 – Building layout showing all dwelling unit Type A and B with window openings facing either the north or south direction. The dwelling unit Type C has no window openings in the north and south directions. In this instance, no unit can be considered meeting the requirement 1.3c (ii) on building layout design that utilises prevailing wind conditions to achieve adequate cross ventilation.

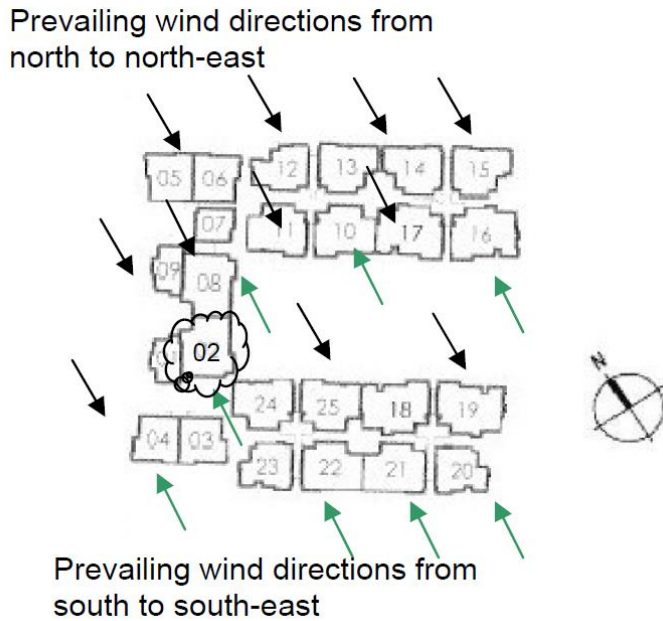

Illustration 3 – Building layout showing the window openings of all dwelling units facing the north and south direction except dwelling unit 02. Dwelling 02 has window openings facing only the south direction and hence it is not considered meeting the requirement 1.3c (ii) on building layout design that utilises prevailing wind conditions to achieve adequate cross ventilation.

Illustrations on dwelling unit design that facilitates true cross ventilation

Dwelling unit design is considered to have true cross ventilation when there is a reasonably unobstructed air flow path between the windows or vents on opposite sides of the building. For this requirement, the main entrance of the dwelling units is assumed to be closed and all the windows / internal doors are assumed to be open.

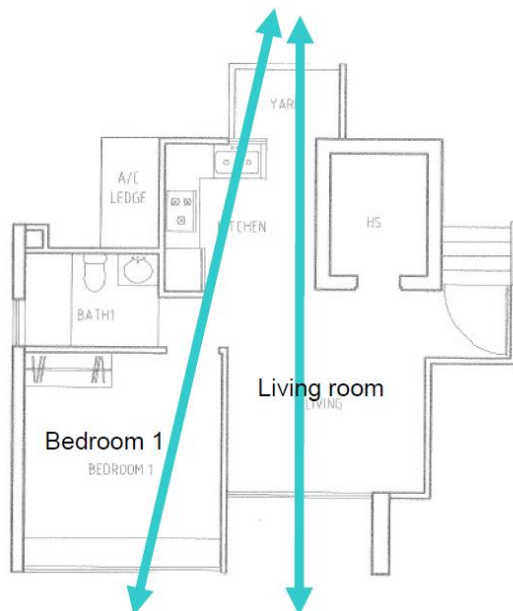

Illustration 4 – Dwelling unit layout showing that both living room and bedroom 1 are considered to have true cross ventilation and meet the requirement 1.3c (ii) on dwelling unit design that allows for true cross ventilation in the living room and bedroom.

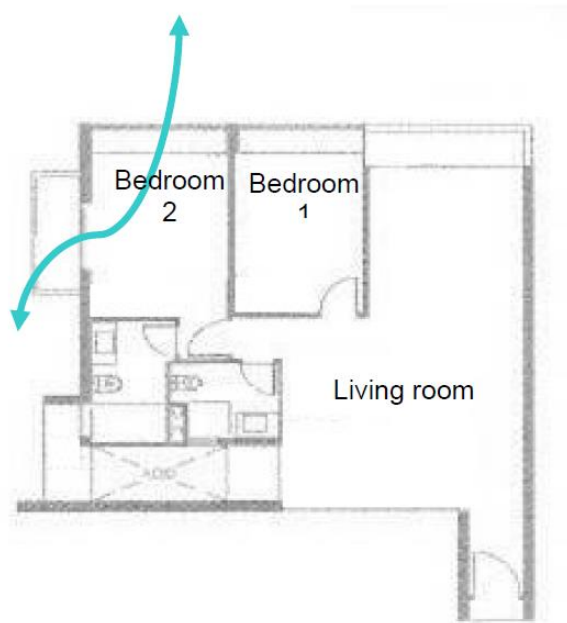

Illustration 5 – Dwelling unit layout showing only bedroom 2 is considered to have true cross ventilation. Living room and bedroom 1 are not considered meeting the requirement 1.3c (ii) on dwelling unit design that allows for true cross ventilation in the living room and bedrooms.

Documentary Evidences

At Design Stage:

Submission of the following where applicable:

- For Air Flow within Dwelling Units
 - Floor plan of all the unit types with highlights of those with window openings facing the north and south directions and/or with true cross ventilation;
 - Schedules showing the total number of units in the development and those with window openings facing the north and south direction.
 - Schedules showing the total number of living rooms and bedrooms in the development and those with true cross ventilation.
 - Calculation showing the percentage of living rooms and bedrooms of dwelling units with true cross ventilation
- For CFD Simulation
 - Testing reports summarising the analysis and modelling results as well as recommendations for design. Refer to Annex A for details.
 - Calculation showing the percentage of units achieving good natural ventilation in the prescribed tabulation format

Verification (As Built):

Submission of as built drawings of the approved floor plans.

5.1a Passive Design Strategies (Advanced Green Efforts)

To encourage design that optimized prevailing wind conditions and facilities air flow.

Assessment

Up to 3 points shall be awarded for the following design:

1 point can be scored for development with at least 80% of the multiple blocks, stagger blocks such that blocks behind are able to receive wind penetrating through the gaps between the blocks in the front row or arrange building according to ascending height with lower height in front and towards the direction of prevailing wind.

1 point can be scored for provision of either void decks at the ground floor or void spaces in between buildings to encourage air flow through and around buildings. Extent of coverage, at least 80% of applicable areas.

1 point can be scored for carry out macro ventilation simulation to check block layout to ensure passive design been considered from the early design stage.

Documentary Evidences

At Design Stage:

Submission of the following where applicable:

- Development layout design showing optimizing prevailing wind conditions
- Drawings showing provision of either void desks or void spaces in between buildings
- Macro ventilation simulation report summarizing the analysis for checking block layout to ensure passive design as well as the recommendations for design.

Verification (As Built):

Submission of applicable as built drawings.

5.1b Wind Driven Rain Simulation (Advanced Green Efforts)

Use of wind driven rain (WDR) simulation modelling to identify the most effective building design and layout that minimises the impact of wind-driven rain into naturally-ventilated common areas such as lift lobbies and corridors, drop-off area and communal space such as sky garden.

Assessment

Up to 2 points shall be awarded for the use wind driven rain simulation modelling to identify effective building design and layout that minimize the impact of wind-driven rain into naturally ventilated common areas such as lift lobbies and corridors portion where there might be concerned, drop-off area and communal space such as sky garden.

1 point - to conduct wind driven rain simulation to identify effective building design and layout

1 point – for implementation of recommendations

Documentary Evidences

Design Stage:

Submission of simulation results and proof of adherence to the performance requirements listed in Annex A: Computational Fluid Dynamics Simulation Methodology and Requirements

Worked Example

Example 1

A residential development with one block of 20-storey apartments comprises 200 units and with 7 typical dwelling unit layouts or types.

The development conducted step 1 ventilation simulation modelling for the development. Based on step 1 ventilation simulation results, the development cannot meet the primary evaluation parameters. Step 2 ventilation simulation modelling for units was conducted and based on the ventilation simulation results, list down the total number of units for each typical dwelling unit type and its corresponding area-weighted average wind velocity as tabulated below.

	Dwelling unit layouts/ types	No. of units	Area weighted average wind velocity
1	Typical layout A	80	0.60
2	Typical layout B	30	0.60
3	Typical layout C	20	0.70
4	Typical layout D	20	0.50
5	Typical layout E	20	0.40
Total number of selected units:		170	
6	Typical layout F*	15	Not included
7	Typical layout G*	15	Not included

* Dwelling unit layout not selected for simulation

Percentage of units achieving good natural ventilation is given by

$$\frac{\sum (\text{No. of Selected Units for Each Layout} \times \text{Area-Weighted Average Wind Velocity}) \times 100\%}{\text{Total Number of Selected Units} \times 0.6\text{m/s}}$$

$$= \frac{80 \times 0.60 + 30 \times 0.60 + 20 \times 0.70 + 20 \times 0.50 + 20 \times 0.40}{170 \times 0.60} \times 100\%$$

$$= 96\%$$

Points scored for 1.3c under step 2 = $96\%/7 = 10$ points (Max 10 points)

Example 2

Proposed residential development with one block of 10 storey apartment comprises 40 units. Each dwelling comes with a living room and two bedrooms. There are four different unit types for this development as illustrated below.

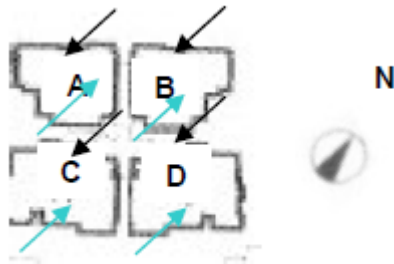

Building Layout Design

Total no. of units in the developments = 40

Total units with all window openings facing north and south directions = 40

% of units with window openings facing north and south directions = $40/40 \times 100 = 100\%$

Points scored = $0.5 \times (\% \text{ unit}/10)$



= $0.5 \times (100/10) = 5 \text{ points}$

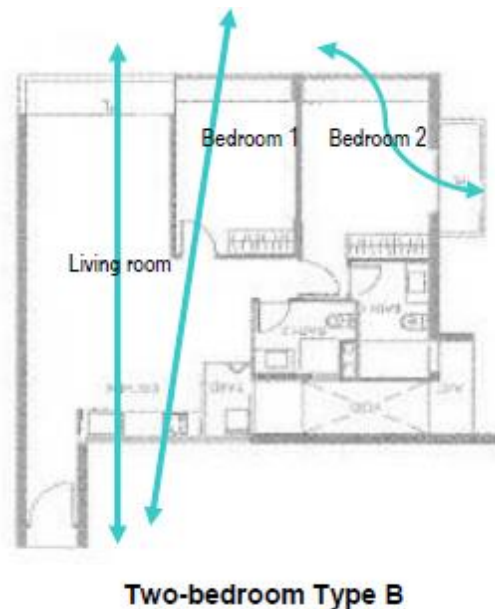

Both living room and bedroom 1 & 2 are considered to have true cross ventilation.



Both living room and bedroom 1 & 2 are considered to have true cross ventilation.

 <p style="text-align: center;">Two-bedroom Type C</p>	 <p style="text-align: center;">Two-bedroom Type D</p>
<p>Only living room is considered to have true cross ventilation. Both bedroom 1 & 2 do not meet the requirement.</p>	<p>Only living room is considered to have true cross ventilation. Both bedroom 1 & 2 do not meet the requirement.</p>

Dwelling Unit Design

Percentage of rooms with true cross ventilation

Type of dwelling unit	No of units (a)	For each unit		Total living rooms and bedrooms with true cross ventilation (b + c) x a
		Living room with true cross ventilation (b)	Bedrooms with true cross ventilation (c)	
2-bedroom Type A	10	1	1	20
2-bedroom Type B	10	1	1	20
2-bedroom Type C	10	1	0	10
2-bedroom Type D	10	1	0	10
Total				60

Total no. of living rooms and bedrooms = 3 x 40 units = 120

Total no. of living rooms and bedrooms with true cross ventilation = 60

Percentage of living rooms and bedrooms with true cross ventilation = $60/120 \times 100$
= 50%

Points scored = $0.5 \times (\% \text{ rooms}/10) = 0.5 \times (50/10) = 2.5$ points

Total points scored for 1.3c(ii) = $5 + 2.5 = 7$ points (max 7 points)

2. Building Energy Performance



The built environment is an important contributor towards reducing global carbon emissions and fossil fuel consumption. This section builds on *Section 1 – Climatic Responsive Design*, and focuses on how building projects can demonstrate the optimisation of building energy systems through energy efficiency, effectiveness and replacement strategies to reduce their environmental impact.

The energy performance of a building is measured through the efficiency of its active mechanical and electrical systems. In the urban tropics, this is mainly attributed to air conditioning systems, artificial lighting and hot water production in some building types. In addition, to consider the energy effectiveness of a building holistically, the extent of use of energy systems in terms of their absolute energy consumption should also be taken into account. Further tapping into opportunities to utilise renewables in place of fossil energy sources, the energy performance of building projects can be improved significantly.

P.5 – P.8 Prerequisites

Criteria	Points
2.1 Energy Efficiency	12
2.2 Energy Effectiveness	5
2.3 Renewable Energy	8
TOTAL	25
<i>Advanced Green Efforts</i>	10

P.5 Vertical Transportation Efficiency

Intent

To adopt energy efficient vertical transportation systems to reduce their energy consumption

Scope

Applicable to all lifts in the development.

Assessment

All lifts to be equipped with Variable Voltage Variable Frequency (VVVF) drives and sleep mode features except for building typologies where such technology is not available.

Documentary Evidences

At Design Stage:

Submission of extracts of specifications that indicate the types of lifts and related features used.

Verification (As Built):

Submission of purchase orders and delivery orders of the installed lifts with the technical product specifications indicating the VVVF motor drive and sleep mode.

P.6 Air Conditioning System Efficiency

Intent

To reduce air conditioning energy consumption where air-conditioning system are provided for the development.

Scope

Applicable to development with air-conditioning system provided for the development.

Assessment

Prescribed energy performance standard of air-conditioning system for all dwelling units to be as follows:

Level of Award	Energy Performance Standard
Gold	Minimum COP _{100%} of 3.78 and weighted COP of 3.76 or more
Gold^{PLUS}	Minimum COP _{100%} of 4.86 and weighted COP of 5.50 or more
Platinum	

Documentary Evidences

At Design Stage:

Submission of the following if applicable:

- Number of dwelling units and types
- Number of air-conditioners provided and its efficiency performance
- Ventilation simulation modelling and analysis

Verification (As Built):

Submission of the following if applicable:

- Delivery orders of air conditioning system and its efficiency performance

P.7 Lighting Efficiency

Intent

The use of energy efficient lighting can reduce the energy needed to illuminate a space.

Scope

Applicable to common areas lighting and car park lightings.

Assessment

The development shall achieve at least 10% improvement in lighting power budget over baseline (excluding external lighting).

Documentary Evidences

At Design Stage:

Submission of the following if applicable:

- Lighting layout plan
- Lighting schedules showing the numbers, locations and types of luminaries used
- Calculation of the proposed lighting power budget and the percentage improvement
- Technical product information of the lighting luminaries used

Verification (As Built):

Submission of the following if applicable:

- Delivery orders the lighting luminaries used

P.8 Renewable Energy Feasibility Study

Intent

To identify the project's potential in harnessing solar energy, and encourage installation of solar photovoltaic (PV) to the project's full potential.

Scope

Applicable to residential buildings with a footprint greater than or equal to 1000m²

Applicable for the following Award levels:	Points
Gold	0.5
Gold^{PLUS}	0.5
Platinum	0.5

Assessment

The project shall complete a feasibility study for solar renewable energy as per requirements under Indicator 2.3a *Feasibility Study*.

Documentary Evidences

As per requirements under Indicator 2.3a *Feasibility Study*.

Definitions

Building footprint is the area on a project site used by the building structure, defined by the perimeter of the building plan. Open car park spaces, landscapes, underground construction spaces and other non-building facilities (e.g. covered walkways, etc.) are not included in the building footprint.

2.01 Energy Efficiency



To encourage buildings to stretch boundaries in optimising the efficiency of their air conditioning and lighting systems. Additionally, given the relatively large area of car parks in many developments, car parks also constitute a significant energy use. Using more efficient systems can reduce their contribution to the building total energy consumption.

Criteria	Points
2.1a Air Conditioning System Efficiency	6
2.1b Lighting Efficiency	4
2.1c Car park Energy	2
TOTAL	12

2.1a Air Conditioning System Efficiency

Intent

The use of energy efficient appropriately-sized and designed air-conditioning systems can reduce energy consumption.

Scope

All residential buildings with air-conditioners provided.

Assessment

Up to 6 points can be scored for the use of energy efficient air-conditioners.

Criteria	Points
Air-conditioners with COP _{100%} ≥ 4.29 and weighted COP ≥ 4.86	3 points
Air-conditioners with COP _{100%} ≥ 4.86 and weighted COP ≥ 5.50	5 points

Note:

$$\text{Weighted COP} = 0.4 \times \text{COP}_{100\%} + 0.6 \times \text{COP}_{50\%}$$

Up to 5 points can be scored for the use of energy efficient air conditioning system. Extent of coverage shall be at least 80% of the air conditioners used in all dwelling units.

Exemplary performance - Effective Ventilation

Up to 1 point can be scored for demonstrating good ventilation effective discharge of hot air from the condenser units to ensure air-conditioning system can achieve its declared efficiency.

Criteria	Points
To demonstrate effective ventilation of the air-conditioning systems through Computational Fluid Dynamic Simulation (CFD).	1 point
OR Development designed with adequate clearance distance for condenser units (Refer to Table 2.1a-1) and screens for condenser units shall be more than or equal to 70% of free area.	0.5 point

Computational Fluid Dynamic Simulation (CFD)

Use of Computer Fluid Dynamic Simulation Model to demonstrate effective discharge of hot air from the condenser units. Details of the housing of the condenser units such as clearance spaces, nearby obstructions and screens shall be included in the simulation. Investigation using CFD simulation shall be used to model the build-up of hot air for design with stack of condenser units with screens less than 70% of free area or facing obstructions or building block which more than 25 storeys or other potential design which will compromise the efficiency of air conditioning unit. The endorsed CFD report demonstrate the efficiency air conditioning unit is achievable as designed with 3 worst case scenarios within the development.

Table 2.1a-1 : Recommended Clearance Distance for Condenser Units

Configurations of the condenser units with adequate clearance distance free of obstruction(s). The screens for the condenser units shall be **more than or equal to 70% free area** (through flow of the air). The recommended clearance distance shall be free of obstructions of any height or length. Objects of **less than 70% free area** (through flow of the air) shall be considered as an obstruction.

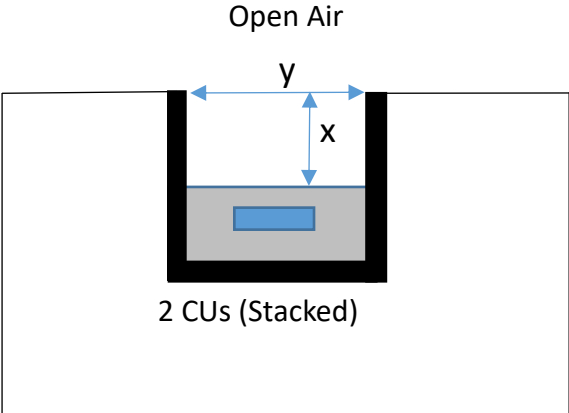
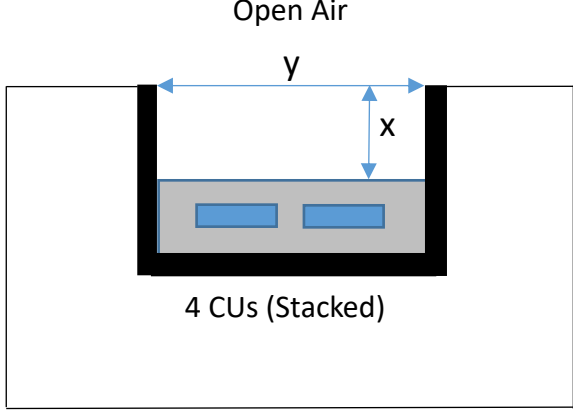
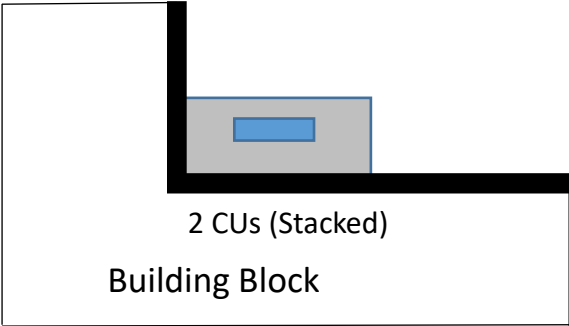
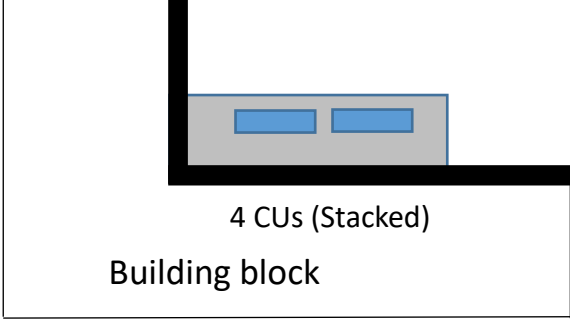
<p>Type 1: Plan View</p> <p>$X \leq 500$ mm $Y \geq 1350$ mm</p> <p>Open Air</p>  <p>2 CUs (Stacked)</p> <p>Building block not more than 25 storeys No slab over condenser units</p>	<p>Type 2: Plan View</p> <p>$X \leq 500$ mm $Y \geq 2400$ mm</p> <p>Open Air</p>  <p>4 CUs (Stacked)</p> <p>Building block not more than 25 storeys No slab over condenser units</p>
<p>Type 3: Plan View</p> <p>Open Air</p>  <p>2 CUs (Stacked) Building Block</p> <p>Building block not more than 25 storeys No slab over condenser units</p>	<p>Type 4: Plan View</p> <p>Open Air</p>  <p>4 CUs (Stacked) Building block</p> <p>Building block not more than 25 storeys No slab over condenser units</p>

Type 5:

$X \geq 3500$ mm
 $Y \leq 500$ mm

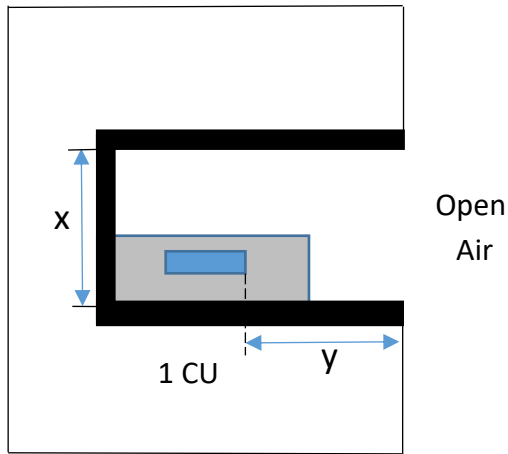

Building block not more than 25 storeys
 No slab over condenser units

Type 6:

$X \geq 4000$ mm
 $Y \leq 500$ mm

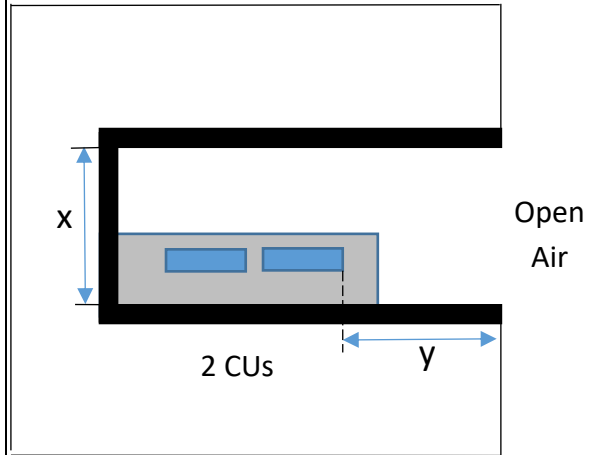

Building block not more than 25 storeys
 No slab over condenser units

Type 7:

$X \geq 3600$ mm
 $Y \leq 4800$ mm

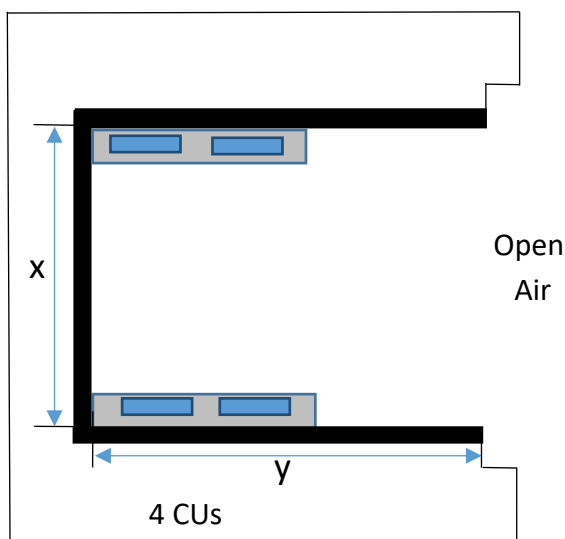

Building block not more than 25 storeys
 No slab over condenser units

Type 8:

$X \geq 4000$ mm
 $Y \geq 2400$ mm
 $a \geq Y$
 $b \leq 1000$ mm

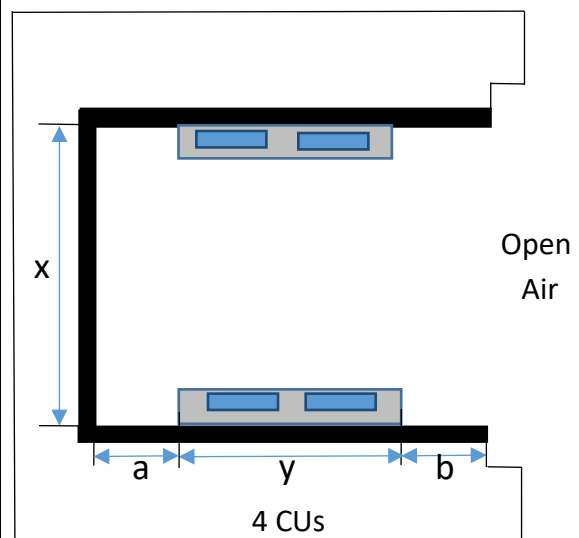

Building block not more than 25 storeys
 No slab over condenser units

For developments where air-conditioners are not provided, points will be scored and prorated under 1.3c (ii) Ventilation Performance

Documentary Evidences

At Design Stage:

Submission of the following:

- Architectural plan layouts and all the air-conditioning areas and units types
- Calculation of the extent of coverage, number of air-conditioning system and the respective Energy Label with reference to the dwelling units.
- Demonstrate the percentage of coverage according to the numbers of dwelling units;
 - Energy Efficient Air-conditioners - Achieve the minimum coverage of 80% of dwelling units
 - Effective Ventilation, CFD or Adequate Clearance Distance for Condenser Units – Achieve the declared efficiency of the air-conditioning system
- **Computer Fluid Dynamic Simulation (CFD)**
 - The CFD simulations shall include free area of the screens for condenser units.
 - The CFD report to summarise the analysis and results for the condenser units within the development.
 - Results from the CFD report to demonstrate the units achieving the declared efficiency of the air-conditioning system.

Or

- **Adequate Clearance Distance for Condenser Units**
 - Architectural plan layouts and all the air-conditioning areas and units types and the distance of obstructions from the condenser units.
 - The screens for the condenser units shall be more than or equal to 70% free area (through flow of the air).
 - Calculation on number of dwelling units that are able to meet the adequate clearance distance for condenser units.

Verification (As Built):

Submission of the following:

- Delivery orders of the air-conditioning systems and the respective Energy Label according to unit types. Free area of the screens for condenser units.

Worked Examples

Example 1: Air-conditioning Coverage

Type of Rooms	Number of Dwelling units	COP _{100%} ≥ 3.78 and weighted COP ≥ 4.29	COP _{100%} ≥ 4.86 and weighted COP ≥ 5.50
Type 1 -1 room	10	10	
Type 2 -2 rooms	10	10	
Type 3 - 3 rooms	10	10	
Type 4 - 4 rooms	230		230
Type 5A -5 rooms	20	20	
Type 5B -5 rooms	20		20
Total Number of Dwelling Units	300		

Total number of units for the development/building =300 units

Number of dwelling units with COP_{100%} ≥ 3.78 and weighted COP ≥ 4.29

= 10 units of Type 1 + 10 units of Type 2 + 10 units of Type 3 + 20 Units of Type 5A

= 50 units /300 units

= 16.7% coverage

Number of dwelling units with COP_{100%} ≥ 4.86 and weighted COP ≥ 5.50

= 230 units of Type 4 + 20 Units of Type 5B

= 250 units /300 units

= 83.3% coverage

More than 80% of the dwelling units are provided with COP_{100%} ≥ 4.86 and weighted COP ≥ 5.50.

Points scored 5 points, project complies with the pre-requisites for Gold^{PLUS} and Platinum award.

Exemplary performance - Effective Ventilation (Calculation of Free Area of Screens)

Example 2a : Louvers panels – Plan detail

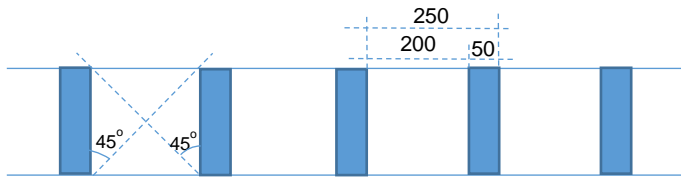

Opening ratio = $(200/250) \times 100\% = 80\%$ (condenser units and screens $\geq 70\%$ free area)

Example 2b Louvers panels – Elevation detail

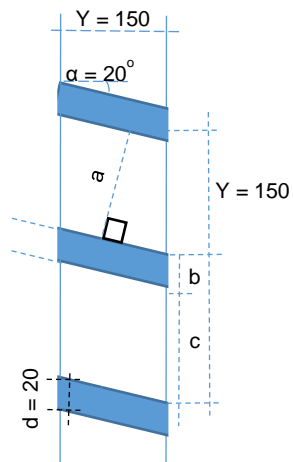

Thickness of the louver plate (d) = 20

Calculation on percentage of free area of the screens for condenser units

$$b = d / \cos \alpha = 20 / \cos 20^\circ = 21.3$$

$$c = 150 - b = 150 - 21.3 = 128.7$$

$$a = c \times \cos \alpha = 128.7 \times \cos 20^\circ = 120.94$$

$$\text{Opening ratio} = a/y \times 100\%$$

$$= 120.94 / 150 \times 100\% = 80.6\% \quad (\text{condenser units and screens } \geq 70\% \text{ free area})$$

2.1b Lighting Efficiency

Intent

Encourage the use of energy efficient lighting in common areas to minimise energy consumption from lighting usage while maintaining proper lighting level.

Scope

Applicable to common areas lighting, car park lightings.

Assessment

Criteria	Points
Lighting System Efficiency	4

Up to 4 points can be scored based on 0.12 point for every percentage improvement in the lighting power budget above 10% improvement over baseline.

Baseline = Maximum lighting power budget stated in SS530

The lighting should be designed to the recommended lux levels in SS 531 – 1– Code of Practice for Lighting of Workplaces.

Documentary Evidences

At Design Stage:

Submission of the following:

- Drawings showing the location of luminaries with supporting specifications/catalogues.
- Lux calculation for each space type.

Verification (As Built):

Submission of the following:

- Purchase orders/ delivery orders of the luminaries
- Lux reading for each space type.

Worked Examples

Example 1

Description	Areas	Design Data				SS530: 2014 Requirements	
		Number of fittings	Type of fittings	Total Consumption (by area) (W)	Design Lighting Power Budget (W/m ²)	Reference Lighting Power Budget (W/m ²)	Reference Total Power Consumption (by area) (W)
Corridors	1600	800	7W LED	5600	3.5	7.00	11200
Stairs	450	120	2x10W LED	2400	5.3	6.00	2700
Lift Lobbies	1000	700	7W LED	4900	4.9	7.00	7000
Carpark	9000	900	2x10W LED	18000	2.0	3.00	27000
			Total	30900		Total	47900

% improvement over baseline = 35.49%

Point scored = 0.12 x (35.49% -10%) = 3.06 points

2.1c Car Park Energy

Intent

To encourage the use of energy efficient design and control of ventilation systems in car park.

Scope

This applies to the development's car park.

Assessment

Criteria	Points
Naturally ventilated car parks	2
Mode of mechanical ventilation provided - Fume extract	1.5
Mechanical ventilated with or without supply (air)	1

Up to 2 points can be scored for the energy efficient design and control of ventilation systems in car park.

For car parks that have to be mechanically ventilated, points can be score for the use of carbon monoxide (CO) sensors in regulating such demand based on the mode of mechanical ventilation (MV) used; 1.5 points for car parks using fume extract and 1 point for those with mechanical ventilation (MV) or without supply (air).

Where there is a combination of different ventilation mode adopted for car park design, the points obtained will be prorated accordingly

Documentary Evidences

At Design Stage:

Submission of the following where applicable:

- Plans layouts showing all car park provisions for the development with highlights of the car park spaces that are designed to be naturally ventilated and/or mechanical ventilated;
- Plan layouts indicating the locations and the number of CO sensors and the mode of ventilation adopted for the design; and
- Calculation showing the points allocation of there is a combination of different ventilation mode adopted for the car park design.
- Type and models of CO sensors and the control strategy for ventilation control.

Verification (As Built):

Submission of as built drawings of the car park ventilation, CO sensors and calculation where applicable.

Delivery orders of CO sensors where applicable.

Worked Example

Example 1: Car Park Calculation

Proposed development has two levels of basement car parks. Level 1 basement car park (B1) is designed with more than 20% openings for natural ventilation and fume extract system. Level 2 basement car park (B2) is fully mechanically ventilated. CO sensors are installed to control the ventilation system for both car parks levels.

Areas of basement car park – B1	= 700 m ²
Areas of basement car park – B2	= 500 m ²
Total areas of basement car park(B1 + B2)	= 1200 m ²
Points score = (700/1200) x 1.5 + (500/1200)x 1	= 1.29 points

2.2 Energy Effectiveness



Besides encouraging energy effective air conditioning, lighting and car park system, to encourage the use of energy efficient features that are innovative and have positive environmental impact in terms of energy saving.

Criteria	Points
2.2a Energy Efficient Practices, Design and Features	5
TOTAL	5

2.2a Energy Efficient Practices, Design and Features

Intent

Encourage the use of energy efficient features that are innovative and have positive environmental impact in terms of energy saving.

Scope

Applicable to energy efficient practices and features not listed in other section of the criteria.

Assessment

Up to 5 points can be scored for the use of energy efficient features based on their potential environmental benefits and extent of coverage. Below are some examples of the energy efficiency equipment and is non-exhaustive.

- Use of gas water heater or energy efficient heat pump water heater
 - 1 point for $\geq 80\%$ of all dwelling units
 - 0.5 point for $\geq 50\%$ and $<80\%$ of all dwelling units
- Heat recovery system
 - 1 point for $\geq 80\%$ of all dwelling units
 - 0.5 point for $\geq 50\%$ and $<80\%$ of all dwelling units
- Provision of lifts with better energy efficient features
 - 1 point for the use of regenerative drive system for at least 80% of lifts installed
 - 0.5 point for the use of gearless drive system for at least 80% of lifts installed
- Energy labelled appliances such as 4 ticks refrigerator, 5 ticks clothes dryer and 5 ticks TV or etc.
 - 1 point for $\geq 80\%$ of all dwelling units for each type of energy labelled appliances
 - 0.5 point for $\geq 50\%$ and $<80\%$ of all dwelling units for each type of energy labelled appliances
- Provision of clothes drying facilities and open spaces
 - 1 point for $\geq 80\%$ of all dwelling units
 - 0.5 point for $\geq 50\%$ and $<80\%$ of all dwelling units
- 0.5 point for calculation of Energy Efficiency Index (EEI) for common facilities of the development.

Documentary Evidences

Design Stage:

Submission of the following where applicable:

- Plans layouts showing all the quantity of energy efficient equipment provided for the development and computation of extent of coverage;

- Extract of the tender specification showing the provision of the proposed energy efficient equipment;
- Features and the extent of implementation where applicable;
- Technical product information on the energy efficient features used;
- Valid certificates by approved local certification body;
- Calculation of the Energy Efficiency Index (EEI) using the pre-determined daily usage pattern and the prescribed tabulated format as shown in the example.

Verification (As Built):

- Delivery orders of products with the corresponding green product certifications
- Submission of as built drawings showing the extent of use of green products within the functional systems

Worked Examples

Example 1: EEI Computation				
Proposed residential development with the following estimated electricity consumption for common facilities.				
	Description	Estimated Load (KW)	Daily Usage (hr)	Load per day (kWh)
A) Mechanical Load				
	MV fan (plant room)	9	9	81
	Car park fan	320	4	1280
	A/C for club house	8	12	96
	A/C for lobbies (1st Stry & basement)	0	12	0
	A/C for guard house	2	24	48
	Domestic pump	70	2	140
	Ejector pump	13	2	26
	Booster pump	28	3	84
	Sump pump	12	0.5	6
B) Lift Load				
	Passenger lifts	470	2	940
	Service lifts	0	2	0
C) General Lighting				
	Car park lighting – 24 hrs operation	23	24	552
	Car park lighting – 5 hrs operation	23	5	115
	Guard house lighting	0.3	12	3.6
	Façade lighting	0	5	0
	Landscape lighting – 12 hrs operation	30	12	360
	Landscape lighting – 5 hrs operation	28	5	140
	Lift lobbies, corridor & staircase lighting – 12 hrs operation	30	12	240

Lift lobbies, corridor & staircase lighting – 5 hrs operation	19	5	95
D) Club Facilities			
Club house interior lighting	12	12	144
Power to Gym equipment, SPA, etc.	85	6	510
Swimming pool filtration	50	12	600
Water Feature	25	8	200
Total kWh per day			5660.60

Calculation of EEI for Common Facilities

Total electricity consumption per day = 5660.60 kwh/day

GFA = 40,000 m²

EEI = (TEC / GFA) x 365 days

= (5660.60/40,000) x 365

= 51.65 kWh/m²/year

Point scored = 0.5 point

2.3 Renewable Energy



After considering energy efficiency and effectiveness, replacement of fossil energy use with renewables should also be looked into. This indicator focuses on driving the creation of opportunities for generation and utilisation of renewable energy. It aims to spur and acknowledge efforts by buildings to work towards the vision of zero energy or net positive energy low-rise buildings and low energy high-rise buildings.

Note: Renewable energy and solar energy are used synonymously here because in the context of Singapore's tropical climate coupled with limited natural resources, solar energy is the most viable renewable energy option.

Criteria	Points
2.3a Feasibility Study	0.5
2.3b Solar Ready Roof	1.5
2.3c Replacement Energy	6
TOTAL	8
Advanced Green Efforts	10

2.3a Feasibility Study

Scope

A building's footprint refers to the area on a project site used by the building structure, defined by the perimeter of the building plan. Open car park spaces, landscape, underground construction and non-building facilities such as covered walkways are not included in the building footprint.

Assessment

0.5 point can be scored for a solar feasibility report that details the following:

- Roof characteristics and shading considerations
- Technical solar energy generation potential
- Economics of solar installation
- Roof access and safety requirements
- Roof spatial optimisation recommendations

Documentary Evidences

At Design Stage:

Submission of the following:

- Solar feasibility report acknowledged by the QP/PE (Electrical)/PV specialist, and the project manager
- Any considerations for shading due to external factors beyond the project site area supplemented with site drawings (or future development plans) that depict the estimated height of shading source

Table 2.3-1 Renewable Energy Feasibility Report Format

Executive Summary – A non-technical summary of the potential for solar adoption for the building.

Roof Characteristics and Shading Considerations – description of the roof characteristics (i.e. number of roofs, roof area, and height variation of various roofs) to be provided with drawings.

Any potential shading from external sources (e.g. adjacent buildings, trees, etc.) as well as internal sources from within project (e.g. M&E services, lamp posts, etc.) are to be considered and quantified.

Technical Solar Energy Generation Potential – Based on the shading consideration and any site specific constraints, the following information is to be provided using the prescribed list of assumptions provided below. Any unique assumptions are to be clearly stated.

- i) Expected solar capacity (in kWp) potential on the roof based on shading consideration and layout
- ii) Expected annual electricity generation (in kWh) based on solar capacity potential

Economics of Solar Installation - Using the electricity generation potential, the economics of the solar installations are to be quantified with the following considerations.

- i) Upfront costs of installation
- ii) Expected maintenance costs
- iii) Expected annual electricity bills based on energy consumption calculation
- iv) Expected costs saving for generation of electricity to be consumed on site
- v) Expected revenue from solar electricity sold to grid (if applicable)
- vi) Payback period/Discount rate

Guiding Assumptions

- i) Solar PV technologies (unshaded) with area efficiency of 0.1 kWp/m² and annual generation yield of 1200 – 1300 kWh/kWp can be assumed if project has not decided on the specific PV technology to be used
- ii) Tariff at \$0.23 per kWh for low tension rate and \$0.18 per kWh for high tension rate can be assumed if project has not have information on potential electricity tariff.

Roof Access and Safety requirements – Identify the access and safety measures that would have to be installed.

Roof Optimisation Recommendations – Recommendations for the spatial optimisation of the roof design to facilitate including M&E equipment locations to maximise the usable roof space.

Acknowledgement from QP/PE and Developer - Acknowledgements from QP/PE (Electrical) / PV specialist AND Developer's Project Manager are to be provided for the feasibility study report.

2.3b Solar Ready Roof

Scope

To recognise the roof as a resource and encourage an optimised roof area for the deployment of renewable energy or other relevant uses.

Assessment

The project shall demonstrate its roof design for solar readiness for least 50% of feasible roof area determined through 2.3a. 0.5 points each can be scored for the following, capped at 1.5 points:

- **Structural readiness:** Roof to be designed to accommodate an optimised easy structural installation of solar panels on rooftop spaces
- **Electrical readiness:** Provisions to be put in place to accommodate an optimised easy electrical installation of solar panels on rooftop spaces
- **Spatial readiness:** Roof to be designed to optimise the available non-shaded rooftop area for photovoltaic adoption of roof spatial optimisation recommendations outlined in *Part 2.3a Solar Feasibility Study*.

Where solar panels are installed under *2.3c Adoption of Renewable Energy*, the area coverage of the feasible roof area by the panels can be counted towards compliance under this indicator.

Documentary Evidences

Design Stage:

- Detailed drawings showing the roof readiness, including the location and method of provision for structural readiness and electrical readiness. For solar energy, at least 50% of feasible roof area (based on feasible capacity stated in feasibility study report) has to be set aside and considered as the basis for design.

Verification Stage:

As built drawings and on site photographs of:

- Solar roof anchors
- Roof layout and space provisions for solar systems
- Evidence of roof readiness for other systems which are being adopted where applicable

Work Examples

Work Example 1

Structural readiness

The building and roof shall be able to support any additional static and wind load imposed by the PV system. Depending on the type of roof and components of the PV installation, the static load

differs. For wind load, it depends on the installation angle. In terms of roof designed to accommodate easy structural installation of solar panels, examples (non-exhaustive) are as follows:

- Metal roofs: The use of roof profiles with suitable seams that allow easy application of roof clamps, and avoid trapezoidal or corrugated profile
- Trellis: The use of trellis with 10-15° slope instead of horizontal top surface, to facilitate optimal module tilt angle
- RC roof: The provision for a solution that does not require heavy ballast to prevent modules from lifting off in strong wind. (e.g. provision of anchor points for solar support systems prior to waterproofing)

Electrical readiness

- Provision of room or sheltered space at roof level or max one level below, to accommodate inverters, circuit breakers and PV feed-in switch boards
- Correct dimensioning of enough circuit breakers for PV feed-in
- Pre-connecting PV feed-in switch boards to main AC switch board

Spatial readiness

- Shifting of shade-casting structures such as staircase doghouses, lift motor rooms, water tanks and M&E equipment away from the east-west sun path, where possible

2.3c Adoption of Renewable Energy

Scope

This involves the use of renewable energy sources within the building development to reduce consumption of power from the grid and the building's carbon emissions.

Assessment

Criteria	Points
(i) Replacement Energy	6
<i>Additional Replacement Energy (Advanced Green Efforts)</i>	<i>10</i>

The Energy Efficiency Index of common areas (exclude household's usage) shall be used to calculate savings from replacement of the building electricity consumption through the use of renewable energy.

1 point for every 1% replacement of electricity (exclude household's usage) by renewable energy, up to a cap of 6 points.

Additional Replacement Energy (Advanced Green Efforts)

To encourage additional replacement of electricity (based on building electricity consumption) by renewable energy.

Up to 10 points can be scored with every 1 point for every additional 10% replacement of electricity (exclude household's usage) by renewable energy.

Documentary Evidences

Design Stage:

- Technical product information on the salient features of the renewable energy system and the expected renewable energy generated; and
- Detailed drawings showing the location and renewable energy provisions
- Calculation of the percentage replacement of electricity and the total annual electricity consumption of the development common area EEI.

Verification Stage:

- As built drawings and on site photographs of the renewable energy source(s)
- Technical specifications and integration reports of the installed system(s) including total capacity installed
- Testing and commissioning report
- Logging of the energy production and calculated energy replacement rate
- Purchase Order/Delivery Order of the total capacity installed
- Updated EEI, reflecting as-built building energy consumption and actual capacity installed

3. Resource Stewardship



With global use of resources increasing in the backdrop of the limited carrying capacity of the Earth, it is imperative that we work towards conserving the Earth’s resources for future generations. “Resource Stewardship” in the built environment refers to the responsible use and protection of the environment through conservation and sustainable practices. This section rewards projects for the responsible use and conservation of resources from the stages of construction through to building operations and occupancy. Resources covered include water, construction materials, construction and operational waste.

P.9 – P.12 Prerequisites

Criteria	Points
3.1 Water	13
3.2 Materials	18
3.3 Waste	4
TOTAL	35
<i>Advanced Green Efforts</i>	7

P.9 Water Fittings for Common Facilities

Intent

The provision of water efficient fittings can reduce the building's potable water consumption in common areas.

Scope

Applicable to all common facilities with water fittings installed.

Assessment

The project shall demonstrate the use of water efficient fittings that meet minimum requirements as detailed in the following table:

Type of Water Fittings	Prescribed Rating based on Water Efficiency Labelling Scheme (WELS)
Basin Taps & Mixers	✓✓✓
Sink Taps & Mixers	✓✓
Shower Taps, Mixers or Showerheads	✓✓
Dual Flush Flushing Cisterns	✓✓

Exemptions can be granted on a case-by-case basis, where there are special functional needs. All other water fittings such as flush valves, bib taps that are not listed in the above table shall comply with the mandatory standards stipulated in the *Singapore Standard CP 48– Code of Practice for Water Services*.

Documentary Evidences

At Design Stage:

Submission of the following:

- Extracts of the tender design specification showing the provisions of all water fittings for common facilities;
- Water fittings schedules showing the numbers, types and WELS rating of proposed fittings in the prescribed tabulated format as shown:

Water Fitting Type	Quantity		State location	Total no. based on fitting type
	WELS 3 Ticks	WELS 2 Ticks		
Basin Taps & Mixers				
Sink Taps & Mixers				
Shower Taps & Mixers or Showerheads				
Dual-Flush Flushing Cisterns				
Total no. based on WELS rating :			Total no. of water fittings :	

Verification (As Built):

- As-built water fitting schedules showing the numbers, types, WELS rating, delivery order reference no. and brands/models of installed fittings in similar tabulated format as above.
- Purchase orders/ delivery orders of installed fittings to demonstrate compliance to the committed design specifications.

Worked Example

Example 1

A residential development where the pre-requisite has been met for common facilities:

Water Fitting/ Product Type	Quantity		Location	Delivery Order Ref No / Brand	Total no. based on fitting type
	WELS 3 Ticks	WELS 2 Ticks			
Basin taps & mixers	8		Common toilets	T1234/ Xbrand	10
	2		Function rooms	T1897/ Xbrand	
Sink taps		2	Function Rooms	T4321/ Abrand	4
		2	Barbeque pits	T4321/ Abrand	
Shower taps & Mixers		7	Swimming pool - Shower facilities	T2343/ ZXbrand	7
Showerheads	7		Swimming pool - Shower facilities	T7648/ YZbrand	7
Dual flush Flushing Cisterns		4	Common toilets	T2454/ FVbrand	4
Total no. based on WELS rating :	17	15	Total no. of water fittings :		32

P.10 Sustainable Construction

Intent

To encourage the adoption of building designs, building structures and construction practices that are environmentally friendly and sustainable.

Scope

Applicable to building superstructure (including non-structural components). Substructure components are excluded

Applicable for the following Award levels:	Points
Gold	0.5
Gold^{PLUS}	2
Platinum	3.5

Assessment

As per requirements under 3.2a *Sustainable Construction* and achieve the minimum points required as indicated above

Documentary Evidences

At Design Stage:

As per requirements under Indicator 3.2a *Sustainable Construction*

Verification (As Built):

As per requirements under Indicator 3.2a *Sustainable Construction*

P.11 Embodied Energy

Intent

To better quantify the environmental impact of a building and raise awareness among key decision makers.

Scope

Applicable to all projects.

This involves the calculation of the embodied energy of a building through the use of the BCA Online Carbon Calculator through the minimum declaration of concrete, glass and steel.

Applicable for the following Award levels:	Points
Gold^{PLUS}	1
Platinum	1

Assessment

As per requirements under Indicator 3.2b *Embodied Energy*.

Documentary Evidences

As per requirements under Indicator 3.2b *Embodied Energy*.

P.12 Sustainable Products

Intent

To ensure that due consideration is given to the specification and use of environmentally friendly products within the building

Scope

Applicable to buildings:

Applicable for the following Award levels:	Points
Gold	2
Gold^{PLUS}	3
Platinum	4

Assessment

Projects shall submit the evidence and be assessed according to the requirements within 3.2c demonstrating their use of locally approved certified products.

Documentary Evidences

At Design Stage:

As per requirements under Indicator 3.2c *Sustainable Products*

Verification (As Built):

As per requirements under Indicator 3.2c *Sustainable Products*

3.1 Water



With increasing occurrences of droughts and dry spells attributed to varying weather phenomenon and global warming, bouts of water shortage globally is an ever imminent threat. Given limited natural water resources, it is crucial to manage water demand so as to ensure long term water supply adequacy and resilience. Considering water efficient, monitoring and potable water replacement strategies in building design can help reduce potable water consumption and raise awareness on responsible use of water.

Criteria	Points
3.1a Water Efficiency Measures	9
3.1b Water Usage Monitoring	1
3.1c Alternative Water Sources	3
TOTAL	13
Advanced Green Efforts	3

3.1a Water Efficiency Measures

Intent

To encourage responsible use of water and to reduce potable water consumption through the use of water efficient fittings/products and systems.

Scope

Applicable to buildings with water fittings / products or landscape irrigation.

Assessment

Criteria	Points
(i) Water efficient products for dwelling units	7
(ii) Landscape Irrigation and/or drought tolerant plant	2

- (i) A maximum of 7 points can be scored for the provision of water efficient fittings/products for dwelling units. The points to be derived based on the number, water efficiency rating, product types and the weightage assigned as shown in the following table.

Product Type	Rating based on Water Efficiency Labelling Scheme (WELS)	Weightage for Point Allocation
Water Fittings <ul style="list-style-type: none"> Basin Taps & Mixers Sink Taps & Mixers Shower Taps & Mixers or Shower Heads Dual-flush Flushing Cistern 	✓✓	6
	✓✓✓	7
Clothes Washing Machine	✓✓✓	6
	✓✓✓✓	7

- (ii) 0.5 point each can be scored for the following, capped at 2 points:

- Every 25 % of the landscape areas that are served by water efficient automated irrigation system such as automatic drip irrigation with moisture or rain sensor control– 0.5 point
- Every 20% of the landscape areas that comprises drought tolerant plants – 0.5 point

Documentary Evidences

At Design Stage:

Submission of the following:

- Extracts of the tender design specification showing the provisions of all water fittings and products for the dwelling units;
- Water fittings/products schedules showing the numbers, types and WELS rating of proposed fittings/products in the prescribed tabulated format shown:

Product Type Used for Dwelling Units	Quantity			Total no. based on fitting type
	WELS 3 Ticks	WELS 2 Ticks	Mandatory MWELS	
Water Fittings				
Basin Taps & Mixers				
Sink Taps & Mixers				
Shower Taps & Mixers or Showerheads				
Dual-flush Flushing Cisterns				
Others	WELS 4 Ticks	WELS 3 Ticks	Mandatory MWELS	Total no. based on product type
Clothes Washing Machine				
Total no. based on rating (A)				ΣA
Weightage (B)	7	6	-	
Total (AxB)			-	
Points Scored				$\Sigma(A \times B) / \Sigma A$

- Extracts of the tender and design specification showing the provision and details of the water efficient irrigation system
- Relevant layout plans showing the overall landscape areas and the areas that would be served using the system
- Calculation showing the percentage of the landscape areas that would be served using the system
- Relevant layout plans showing the overall landscaping and areas that use drought tolerant plants.
- Calculation showing the percentage of the landscape areas that would be planted with drought tolerant plants

Verification (As Built):

- As-built water fittings/products schedules showing the number, WELS rating, delivery order reference no. and brands/models of installed fitting and products in the similar tabulated format as above.
- Purchase orders/delivery orders of installed fittings or products to demonstrate compliance to the committed design specification.
- As-built layout plans showing the location of the water efficient irrigation systems and determine compliance with the committed design specifications
- Purchase/delivery orders for the species of drought tolerant plants and determine compliance with the committed design specifications.

Worked Examples

Example 1

Example of the water fitting and product schedule showing the number, type and approved WELS rating of the installed water fittings and products as well as the point scored for this item.

Product Type Used for Dwelling Units	Quantity			Total no. based on fitting type	Delivery Order Ref no.
	WELS 3 Ticks	WELS 2 Ticks	Mandatory MWELS		
Water Fittings					
Basin Taps & Mixers	100	400		500	T1234/Xbrand
Sink Taps & Mixers		200		200	T1897/Xbrand
Shower Taps & Mixers			400	400	T4321/Abrand
Showerheads		400		400	T4321/Abrand
Dual-flush Flushing Cisterns		400		400	T2343/ZXbrand
Others	WELS 4 ticks	WELS 3 ticks	Mandatory MWELS	Total No. based on product type	
Clothes Washing Machine		200		200	T6357/YZbrand
Total no. based on rating (A)	100	1600	400	$\Sigma A = 2100$	
Weightage (B)	7	6	-	$\Sigma(A \times B) = 10300$	
Total (AxB)	700	9600	-		
Points Scored				$\Sigma(A \times B) / \Sigma A = 4.9$	

Example 2

A project has 45% of the landscape areas served by automatic drip irrigation system with rain sensor control. Thus, points scored = 0.5 point (Every 25% of landscape areas served by water efficient irrigation systems attains 0.5 point)

The other 55% of the landscape areas comprises drought tolerant plants. Thus, points scored = 1 point (Every 20% of the landscape areas with drought tolerant plants attains 0.5 point)

Total points scored under 3.1a(ii) = 0.5 + 1 = 1.5 point

3.1b Water Usage Monitoring

Intent

To facilitate setting of water consumption reduction targets and continual monitoring and to encourage user engagement with regard to water management and use.

Scope

Applicable to sub-metering provisions for major water uses of building development.

Assessment

Criteria	Points
(i) Provision of private water meters	0.5
(ii) Smart water metering	1
<i>Smart home water management system (Advanced Green Effort)</i>	3

0.5 point can be scored if private meters are provided for all major water uses in the development which includes irrigation, common area cleaning, swimming pool, water features where applicable.

1 point can be scored where a remote metering system is in place for leak detections and monitoring purposes. There shall be alert features that can be set and triggered to detect the possibility of water leakage.

Documentary Evidences

At Design Stage:

Submission of the following if applicable:

- Extracts from tender specification stating the provision of water metering for all major water uses
- Schematic drawings of cold water distribution system showing the location of the private water metering provided
- Extracts from tender specification and schematic drawings showing the location of remote metering system, how it could provide the salient water usage for common facilities and highlights of the specific alert features to detect water leakage.

Verification (As Built):

Submission of the following if applicable:

- As-built schematic drawings of the cold water distribution system showing the location of the private water metering provided
- As-built schematic drawings showing the details of the remote metering system and water usage data for common facilities.

Smart Home Water Management System (Advanced Green Effort)

Intent

To facilitate further water reduction opportunities by providing households the access to their water usage patterns and data for better monitoring and to encourage water saving habits.

Assessment

1 point can be awarded for the provision of smart home water management system/device which would allow homeowners to access to their own water usage data.

2 points can be awarded for the provision of smart home water management system/device which provides homeowners the breakdown of their major water uses such as showering.

Documentary Evidences

At Design Stage:

- Specification of smart home water management system/device with details on the means of access, trending charts, capability to store data.
- Specification of smart home water management system/device with details on the means of access and functionality.

Verification (As Built):

- Submission of screenshots of the installed smart home water management system/device with salient information of the measured water usage, trending and functionality.

3.1c Alternative Water Sources

Scope

This refers to the use of alternative water sources to reduce potable water consumption for general application and use.

Assessment

Points shall be awarded based on the types of water recycling systems used as well as the extent of reduction in potable water usage due to the use of alternative water sources for general application such as landscape irrigation, toilet flushing or washing of external area and car park areas.

Criteria	Points
(i) NEWater supply	1
(ii) On-site recycled water	1
(iii) Rainwater harvested	1

Guidance Notes

Rainwater harvesting: The minimum rainwater harvesting capacity required is to be based on (i) the demands for rainwater use using parameters such as irrigation needs, no. of occupants or water usage frequency where relevant or (ii) the collection area and precipitation using the following formula:

$$\text{Volume} = \text{Roof Area} \times \text{Precipitation} \times \text{Efficiency}$$

where

Volume (litres): Amount of rain that can potentially be harvested in that time period.

Roof Area (m²): Collection area. For slope, curved, pitch roof or similar form, projected areas can be used.

Precipitation (mm): Amount of rainfall in that time period. Average mean daily rainfall derived from the latest annual total rainfall and annual mean raindays published by Meteorological Services Singapore is to be used in computation.

Efficiency (%): Percentage of water that could be captured, as opposed to splashing out of the system somewhere and it is assumed to be 90% for simplicity.

At Design Stage:

Submission of the following if applicable:

- Schematic drawings showing NEWater supply
- Schematic drawings and detailed system for the collection of on-site water such as greywater recycling
- Layouts showing the rainwater harvesting tank, the volume of the tank, the catchment area and usage areas

Verification (As Built):

Submission of the following if applicable:

- As-built schematic drawings and photographs of the water recycling systems during and after installation where applicable.

3.2 Materials



Buildings are resource intensive in their construction and fit-out, and incur a significant carbon footprint. Adopting sustainable construction design and practices, considering embodied energy from a life cycle approach as well as giving priority to sustainable fit-out systems can reduce the environmental impact of the building.

Criteria	Points
3.2a Sustainable Construction	8
3.2b Embodied Carbon	2
3.2c Sustainable Products	8
	TOTAL 18
Advanced Green Efforts	6

3.2a Sustainable Construction

Intent

To encourage the adoption of building designs, building structures and construction practices that are environmentally friendly and sustainable.

Scope

Applicable to building superstructure (including non-structural components). Substructure components are excluded.

Assessment

Criteria	Points
(i) Conservation and Resource Recovery	1
(ii) Resource Optimisation	7
<i>(iv) Using BIM to Calculate Concrete Usage Index (CUI) (Advanced Green Efforts)</i>	1

3.2a (i) Conservation and Resource Recovery

Intent

To reward conservation of existing building structures and recovery of demolished building materials for reuse or recycling.

Scope

Applicable for projects built on sites with existing building structures.

Where the existing building on site is conserved and not demolished, the full points can be scored.

Assessment

Where existing building structures on site are demolished, 1 point can be awarded for enhanced demolition protocol, where a recovery rate of >35% crushed concrete waste from the demolished building is sent to approved recyclers with proper facilities.

Documentary Evidences

At Design Stage:

Submission of the following if applicable:

- Pre-demolition assessment records of demolition site showing clear recovery/ recycling targets and estimated quantities of salvageable materials
- Method statement detailing how sequential demolition is to be carried out

- Waste management plans such as plan layout showing locations of recycling bins for collection and storage of different recyclable waste, records of waste movement from site to recycling facilities, proposed usage of the various types of recovered waste
- Details of best practice pollution prevention policies and procedures at construction and demolition sites

Verification (As Built):

Submission of detailed records of the volume of waste sent to the relevant approved recyclers.

3.2a (ii) Resource Optimisation

Intent

This section encourages the optimal use of resources via the following ways:

- To optimise concrete use in building projects through the calculation of the project's Concrete Usage Index (CUI) and encourage adoption of sustainable building systems.
- To optimise design and adoption of low- carbon concrete

Scope

Applicable for superstructure works only.

Assessment

Part	Criteria	Points
1	Concrete Usage Index (CUI)	Cap at-4 points
	Adoption of Sustainable Building Systems	
	<i>Using BIM to Calculate Concrete Usage Index (CUI) (Advanced Green Efforts)</i>	1
2	Low-Carbon Concrete	Cap at 3 points

Part 1. Concrete Usage Index (CUI):

Points shall be scored for CUI based on the following table:

Table 3.2a-1. CUI scoring Matrix:

Project's CUI	Points
≤ 0.60	0.5
≤ 0.50	1
≤ 0.45	1.5
≤ 0.40	2
≤ 0.35	2.5

Adoption of Sustainable Building Systems

Points shall be scored for the adoption of sustainable building systems (refer to Table 3.2a-2) based upon the extent of their use as a percentage of the constructed floor area (CFA).

Table 3.2a-2. Some examples of Sustainable Building Systems:

Sustainable Building Systems	Points awarded		
	0.5 points	1.0 point	1.5 points
Pre-stressed Concrete Elements	Total coverage area <50% of CFA	Total coverage area \geq 50% and <75% of CFA	Total coverage area \geq 75% of CFA
Hollow Core or Voided Concrete Elements			
Light Weight Concrete Elements			
*High Strength Concrete Elements			
Structural Steel Elements			
Composite Structural Elements			
Engineered Timber Elements			
Prefabricated Prefinished Volumetric Construction (PPVC) units			
Precast Concrete Elements			
Leave-in Formwork			
Others (to be accepted by BCA on case-by-case basis)			

**Refers to concrete grade >60MPa*

Use of BIM to calculate CUI (Advanced Green Efforts)

1 point shall be scored under Additional Advanced Green Efforts where BIM* is used to compute CUI.

**Note: BCA's CUI BIM add-on tool is encouraged to be used*

Documentary Evidences

At Design Stage:

Submission of the following if applicable:

- Calculation showing the quantity of concrete for each floor level which should include all the concrete building elements, such as non-load bearing and architectural concrete components Calculation should be presented in the prescribed tabulated format (see BCA Green Mark CUI calculation template).
- BIM model or Architectural and structural plan layout, elevation and sectional plans showing the type of building elements/ systems used, the dimensions and sizes of all the building and structural elements.

- Technical product information (including drawings and supporting documents) of the building systems;
- Calculations of the extent of use of alternative construction methods supported by detailed design drawings plan.

Verification (As Built):

Submission of as-built drawings. If there is deviation of the building design, or usage scope of the building systems points shall be recalculated.

Definitions:

Concrete Usage Index (CUI) serves as an indicator of the amount of concrete used to construct the superstructure that includes both the structural and non-structural elements. CUI does not include the concrete used for external works and sub-structure works such as basements and foundations.

It is defined as the volume of concrete in cubic meters needed to cast a square meter of constructed floor area:

$$\text{Concrete Usage Index} = \text{Concrete Volume in m}^3 / \text{Constructed Floor area in m}^2$$

Part 2. Low-Carbon Concrete:

Up to 3 points can be scored based on the design and use of low-carbon concrete, defined as concrete comprising elements such as cements with clinker content $\leq 400 \text{ kg/m}^3$ and/or recycled/engineered aggregates such as recycled concrete aggregates (RCA) and washed copper slag (WCS) from approved sources to replace natural coarse and fine aggregates.

Recycled/ Engineered Aggregates Content

The applicable usage in tonnes for recycled/engineered coarse aggregates e.g. RCA shall not fall below $1.5\% \times \text{GFA}$ and recycled/engineered fine aggregates e.g. WCS $0.75\% \times \text{GFA}$ for points scoring. However, the use of RCA and WCS in structural applications shall be limited to 10% replacement by mass in the mix unless relevant approval is gained by the relevant authorities. The aggregates replacement rate is based upon the total replacement rate by mass of the total concrete mix used in the project for the super-structure.

0.5 point for every 5% replacement rate of coarse and fine aggregates.

Clinker Content:

Up to 2 points can be scored based on the use of concrete containing clinker $\leq 400 \text{ kg/m}^3$ for grades up to C50/60, according to the performance requirements in the specifications. Tiered points will also be awarded for using concrete certified by SGBC based on the extent of environmental friendliness (refer to Table 3.2a-3).

For points scoring, the concrete used shall cover at least 80% of the applicable super-structure concrete by volume. This includes ready-mixed concrete and pre-cast concrete elements.

Table 3.2a-3. Categories of Concrete Used for the Development

*Concrete Categories	Points
Uncertified concrete with clinker content ≤ 400 kg/m ³	0.5
SGBC-certified 1-Tick concrete	1.0
SGBC-certified 2-Tick concrete	1.5
SGBC-certified 3-Tick concrete	2.0

**Note: All SGBC-certified concrete are deemed to have fulfilled the requirement of clinker content <400kg/m³*

Documentary Evidences

At Design Stage:

Submission of the following if applicable:

- Extract of tender specification or proposed concrete mix design showing the maximum clinker content and/or the detailed usage of recycled/ engineered aggregates (e.g. RCA/WCS)
- Calculation showing the quantity of recycled/ engineered aggregates (e.g. RCA/WCS) to be used for the project
- SGBC certification of the concrete products/mixes used for the project

Verification (As Built):

Submission of the following if applicable:

- As-built drawings, highlighting if there is deviation of the building design or usage scope clinkers/ engineered aggregates (e.g. RCA/WCS) in the project. Where there are variations a re-calculation of points will be required
- Delivery orders and details of the actual concrete mix used in the project showing the usage of clinkers/ engineered aggregates (e.g. RCA/WCS)
- SGBC certification of the concrete products/mixes used for the project

Worked Examples

Worked Example 1

Concrete Usage Index

Proposed development comprises a 30 storey block with a basement car park and the following details:

Project Gross Floor Area (GFA) = 60,000m². Superstructure elements are all precast.

The concrete usage index for foundation and basement car park works are excluded in CUI tabulation.

Computation Of Concrete Usage Index

Project Reference No.: AXXXX-00001-20XX

Total no. of storey for the project: 30

Block No: A

	Structural System	Thickness (mm) or size (mm x mm)	Volume of concrete (m ³)	Remark *
1	1st storey			
	1.1 Columns	300x300, 400x400	120	57 nos of C80 300x300 precast columns
	1.2 Beams	300x500, 200x500	320	Precast
	1.3 Slabs	200,225,250	400	Post-tensioned (Total floor area = 1,600m ²)
	1.4 Staircases	175	93.5	Precast
	1.5 Suspended structures like planter boxes, bay windows, ledges etc.	-	0	-
	1.6 Parapets	-	0	-
	1.7 External walls - loadbearing walls	-	0	-
	1.8 External walls - non- loadbearing walls	125	22	Precast green wall (wall area = 176m ²)
	1.9 Internal walls - loadbearing walls	200	55	RC (wall area =275m ²)
	1.10 Internal walls - nonloadbearing walls	100	10	Light weight concrete (wall area = 100m ²)
	1.11 Others (kerbs, ramps, services risers, etc.)	-	15	RC
	Total volume of concrete for this storey (m ³)		1035.5	
	Total constructed floor area for this storey (m ²)		2200	
2	Typical storey (2nd to roof)			
	1.1 Columns	300x300, 400x400	115	Precast

1.2 Beams	300x500, 200x500	301.5	Precast
1.3 Slabs	200,225,250	320	Post-tensioned (Total floor area = 1,280m ² per floor)
1.4 Staircases	175	93.5	Precast
1.5 Suspended structures like planter boxes, bay windows, ledges etc.	-	0	-
1.6 Parapets	-	0	-
1.7 External walls - loadbearing walls	-	0	-
1.8 External walls –non- loadbearing walls	125	22	Precast green wall (wall area = 176m ²)
1.9 Internal walls –non- loadbearing walls	200	50	RC (wall area =250m ²)
1.10 Internal walls – nonloadbearing walls	-	0	-
1.11 Others (kerbs, ramps, services risers, etc.)	-	0	-
Total no. of columns			313
Total volume of concrete for one storey (m ³)			902
Total constructed floor area for one storey (m ²)			1,926.6
Total volume of concrete for 2nd to 30th storey – includes roof level (m ³)			27,060
Total constructed floor area for 2nd to 30th storey – includes roof level (m ²)			57,798
Total volume of superstructure concrete for this project (m ³)			28,095.5
Total constructed floor area of superstructure for this project (m ²)			59,998
Concrete Usage Index (CUI in m ³ /m ²)			0.47

**To indicate if the structural elements are of precast concrete, post-tensioned concrete, high strength concrete (>Grade 60) or reinforced concrete (RC) under the 'Remarks' column.*

Concrete usage for the superstructure	Constructed floor areas
1st storey = 1,035.5 m ³	1st storey = 2,200 m ²
From 2nd to 30th storey = 27,060 m ³ (including roof level)	From 2nd to 30th storey = 57,798 m ² (including roof level)
Therefore, Total concrete usage = 28,095.5 m ³	Therefore, Total constructed floor areas = 59,998m ²

Important notes: The quantities of the concrete for all the structural and non-structural elements for each floor level are to be computed. All the elements listed in the table such as columns, beams, slabs, suspended structures (like planter boxes, bay windows and ledges etc.), parapets, walls and others (service risers, kerbs, ramps etc.) are to be included. The derivation of the concrete volume breakdown must be traceable on the drawings. The concrete usages for foundation and basement works are to be excluded in CUI computation. For project with raft foundation that is also the floor slab of 1st level, half of the volume will be accountable in the CUI calculation.

Based on the point allocation shown in Table 3.2a-1, CUI of $0.47 \text{ m}^3/\text{m}^2 \leq 0.50 \text{ m}^3/\text{m}^2$.

Therefore, points scored = 1 point

Sustainable Building Systems

Adoption rate of recognised building systems for the example is as determined below:

Building element	Coverage based on area on plan
Post-tensioned Slabs	40,000 m ²
High Strength Concrete Columns	$57 \times 0.3 \times 0.3 = 5.13 \text{ m}^2$
Composite steel Beams	100m ²
Lightweight concrete Walls	1000m ²
Precast green walls	2000 m ²
Total	43,105 m²

**Note: Assumes no overlaps in the area of coverage on plan. Alternatively, area of coverage can be directly taken off from the plan drawing instead of a tabular calculation as above.*

From the CUI tabulation, CFA = 59,998 m²

% coverage of key/distinctive system by area = $43,105/59,998 = 71.8\% < 75\%$

Therefore, points awarded = 1.0 point.

Therefore, points scored for this sub-section = 1.0 + 1.0 = 2.0 points

Worked Example 2

Proposed development comprises a 30-sty block with a basement car park as per example for *Concrete Usage Index*.

Clinker content

Two types of Grade 40 Concrete were used for the project:

Type 1 concrete: The total cementitious mix specified is $370 \text{ kg}/\text{m}^3$ of cement by mass. 20% of the cementitious mix was replaced by GGBS. Based on Table 1 of SS EN 197, the cement used for the project is classified as CEM2.

Clinker content of this concrete = $0.8 \times 370 \text{ kg}/\text{m}^3 = 296 \text{ kg}/\text{m}^3 < 400 \text{ kg}/\text{m}^3$.

Extent of use of concrete (by volume) = 40%

The concrete was not certified by SGBC.

Type 2 concrete: The concrete was certified by SGBC with 2-ticks rating (deemed to meet requirement of clinker content $< 400\text{kg/m}^3$).

Extent of use of concrete (by volume) = 60%

Total concrete coverage (Type 1 and Type 2 by volume) that had clinker content $\leq 400\text{ kg/m}^3$ for the superstructure = 100%. Therefore, points scored = 0.5 points. Extra points cannot be scored for certified concrete as not all concrete used is certified.

Replacement of coarse and fine aggregates

The project uses 10% replacement of coarse aggregate with RCA and 5% replacement of fine aggregate with WCS for all slabs, and 30% replacement of coarse aggregate with RCA for all non-load bearing walls in the superstructure.

RCA

Minimum usage requirement for RCA = $0.015 \times \text{GFA} = 0.015 \times 60,000 = 900$ tons

Total concrete volume of all slabs = $400\text{m}^3 + 320\text{m}^3 \times 29 = 9680\text{m}^3$

Total concrete volume of all non-load bearing walls = $22\text{ m}^3 + 10\text{ m}^3 + (22\text{ m}^3 \times 30) + (50\text{ m}^3 \times 30) = 2192\text{m}^3$

[Approximate coarse aggregate content in concrete = 1 ton/m^3]

Total tonnage of RCA used for super structure

= $[(10\% \times 1\text{ ton/m}^3) \times 9680\text{m}^3] + [(30\% \times 1\text{ ton/m}^3) \times 2192\text{m}^3] = 1625.6\text{ tonnes} > 900\text{ tonnes}$, therefore meeting minimum requirement.

Total tonnage of coarse aggregate used for super structure

= $1\text{ ton/m}^3 \times \text{concrete volume (m}^3)$

= $1\text{ ton/m}^3 \times 28095.5\text{m}^3 = 28095.5\text{ tonnes}$

% of total RCA used for replacing superstructure concrete coarse aggregate content

= $1625.6\text{ tonnes} / 28095.5\text{ tonnes} \times 100\% = 5.8\%$

Therefore, points scored = 0.5 points

WCS

Minimum usage requirement for WCS = $0.015 \times \text{GFA}/2 = 0.015 \times 60,000/2 = 450$ tons

Total concrete volume of all slabs = 9680m^3

Total tonnage of fine aggregate used for super structure

= $0.7\text{ ton/m}^3 \times \text{concrete volume (m}^3)$, $0.7\text{ ton/m}^3 \times 28095.5\text{m}^3 = 19666.85\text{ tonnes}$

[Approximate fine aggregate content in concrete = 0.7 ton/m^3]

Total tonnage of WCS used for super structure

= $[(5\% \times 0.7 \text{ ton/m}^3) \times 9680\text{m}^3] = 338.8 \text{ tonnes} < 450 \text{ tonnes}$, therefore not meeting minimum requirement.

Therefore, points scored = 0 points

Therefore, points scored for this sub-section = $0.5 + 0.5 = 1 \text{ point}$

3.2b Embodied Carbon

Intent

Computing the carbon footprint of the development and performing building life cycle analysis can better quantify the environmental impact of a building and raise awareness among key decision makers. To aid the industry with understanding embodied energy, BCA has developed an online carbon calculator that can be used by projects to identify their carbon debt and allow a benchmarking of projects over time.

Assessment

A maximum of 2 points can be scored for the use of BCA's Online Embodied Carbon Calculator to compute the carbon footprint of the development:

- Declaration of Concrete, Glass and Steel – 1 point
- Declaration of additional materials – 1 point (0.25 point per material)

Documentary Evidences

At Design Stage:

Submission of the following if applicable:

- Embodied carbon footprint computation saved and exported in PDF/ xlsx format via BCA's Carbon Calculator and submitted with the relevant supporting documentation and calculations, such as Bill of Quantities, preliminary design cut sheets, concrete mix designs etc. or data extracted from BIM-based tools. Preliminary/ proposed concrete mix designs are acceptable at the design stage, but need to be updated if there are any amendments made to the designs during the verification stage
- For using emission factors from other sources, project teams must provide details of these sources with the relevant calculations
- Detailed report of the carbon footprint of the development including (but not limited to) the quantum and types of materials used within the development, the emission factors with supporting documentation. Examples of other contributing elements that can be considered include emissions from activities during the construction phase and transportation.
- i-Care Carbon Footprint Report endorsed by SIMTech

Verification (As Built):

Submission of the following if applicable:

- Updated concrete mix designs, design cut sheets etc., highlighting the amendments/ changes in the mixes (with supporting documents) if applicable
- Updated carbon footprint computation if there is deviation from the submission at the design stage
- Delivery orders of materials/ products with their corresponding i-Care Carbon Footprint Reports endorsed by SIMTech if relevant

Provide Own Emission Factors with Source Justification (Advanced Green Efforts)

Up to 1 point can be scored for the provision of own material emission factors through BCA's online embodied carbon calculator (0.25 point per material)

Compute the Carbon Footprint of the Entire Development (Advanced Green Efforts)

Up to 2 points can be scored for computation of the carbon footprint of the entire development and a detailed carbon footprint report based on all the materials used within the development.

3.2c Sustainable Products

Intent

To promote resource efficient and environmentally friendly specifications of products in a building to minimise the resources used in the fit-out of the building.

Scope

Applicable to non-structural building, architectural, mechanical components and building services products.

Assessment

Criteria	Points
(i) Functional Systems	8
(ii) Singular Sustainable Products outside of Functional Systems	2
Total (i) and (ii)	Cap at 8 Points
<i>(iii) Use of SGBP Very Good or above rated products (Advanced Green Effort)</i>	2

Points can be scored for environmentally friendly products certified by approved local certification bodies.

For specification purposes, the products would be based upon the listed functional systems (3.2c (i)) which recognises off form finishes (where additional products or finishes are not required)

For singular products outside these functional groups shall be scored in 3.2c (ii), examples (the list is not exhaustive) such as:

- Water drainage products: Drains, gratings, drainpipe, culvert, rainwater collection tanks
- Landscape products: Drainage cells, green wall/ roof planting system, man-made grass, slope retainers, certified termite treatment, certified swimming pool/ pond water treatment
- Pedestrian and vehicular products: Pavers, road humps, wheel stoppers, road kerbs
- Community leisure products: Playground equipment, fitness/ playground flooring, decking, outdoor furniture
- Mechanical and Electrical products: Chillers, transformers, switchboards, pumps, fans, motors; sensors, distribution boards, Electrical Energy Storage System
- Firefighting products
- Plumbing and sewerage products: Piping and joints, inspection chambers
- Other building products: Shading devices, light (sun) pipes, connectivity, cabling, ducting, toilet partitions, workstations

To recognise the use of products that are certified to higher tiers of environmental performance under Singapore Green Building Product Certification scheme points are given for products used which are certified as 2 ticks or above.

3.2c (i) Functional Systems

The term is used to describe the holistic use of products within the respective functional (operational) systems. The interior architectural fit-out of buildings is made up of 6 major building components for specific functional uses, e.g. the external wall, internal wall, flooring, doors, ceiling and roof. The functional systems described in the Green Mark criteria awards Green Mark points when products are used holistically in the respective functional use. The products included in the functional system are dependent on the choice of products and the installation methodology to provide the functional system for what the space is designed to be used for. Products are thus classified into need-based groups/ systems. As such, the criteria recognises the use of less resources - where a functional system could meet the operational requirement by using less products, this is still considered as meeting the functional system objective. For example, if there is no need to plaster or skim coat to the slab soffit nor need for ceiling boards to cover the overhead, this can be considered to have met the functional system requirement for ceiling for that sectional area of the application.

Assessment

Up to 8 points can be scored through the specification and use of green products certified by approved local certification bodies. In Singapore this is the Singapore Green Building Council and the Singapore Environment Council.

Points are scored through the following methodology, using either Table 3.2c-1 or Table 3.2c-2:

Table 3.2c-1 When whole building (including dwelling units) are declared using sustainable products

Functional System Category	Base Group (To score this group prior to score for Finishes Group)	Finishes Group	(Advanced Green Efforts)
	Coverage >60%	Coverage >60%	
Internal Wall	1	2	2 ticks- 0.25 3 ticks- 0.5 4 ticks- 1 (Functional system and Singular combined Cap at 2)
Internal Floor	1	2	
External Wall	1 (>80%)	2 (>80%)	
Roof	0.5 (>80%)	0.5 (>80%)	
Doors	1	0.5	
Ceiling	0.5	0.5	

Table 3.2c-2 When Common area and back of house only (exclude dwelling units) are declared using sustainable products

Functional System Category	Base Group (To score this group prior to score for Finishes Group)	Finishes Group	(Advanced Green Efforts)
	Coverage >80%	Coverage >80%	
Internal Wall	0.5	1	2 ticks- 0.25

Internal Floor	0.5	1	3 ticks- 0.5 4 ticks- 1 (Functional system and Singular combined Cap at 2)
External Wall	1	2	
Roof	0.5	0.5	
Doors	0.5	0.25	
Ceiling	0.25	0.25	

Note:

The distribution of points will be less when the project excludes dwelling units in the consideration of sustainable product usage in the functional system methodology; i.e. only common areas are to be scored.

The coverage for External wall and Roof system shall be >80% for both table.

Pre-requisite scores are to be obtained from Functional System and/or singular products.

Guidance Notes

Tables 3.2c-3 to 3.2c-8 provide more details on the product groupings within the functional systems. For systems which have an off form finish, such as exposed ceilings, these areas will be considered deemed to comply (i.e. green labelled). Products exclude structural systems such structural floors, the structural walls, structural roof.

All products used in in the base system for the stipulated percentage area (80% or 60% coverage, depending on scope of product used) must be certified green products for points to be scored for the respective functional level.

For scoring under the functional systems, level 1 shall be achieved before level 2 can be scored.

When specifying the finishes the design team should make reference to Healthy Building indicator 4.1c Contaminants, as the relevant finishes can be scored under 4.1c (iii) for being low VOC emitting Certified low VOC Paints are a pre-requisite (P.13).

Documentary Evidences

At Design Stage:

- Extracts of the tender design specification showing the building functional systems and descriptions of each.
- Tabulate all the functional system in a table and identify where sustainable products are used and the corresponding information of the products clearly shown
- Design drawings marking the extent of use for each compliant functional system and the calculation of the extent of use.
- Design details of the systems used within each functional system; i.e. construction method/ method statement details
- Product certificates

Verification (As Built):

- As built drawings showing the extent of use of green products within the functional systems
- Delivery orders of products with their corresponding green product certificates

The example below given using the point calculation when whole building, including dwellings units are declared using sustainable products

Table 3.2c-3 – Flooring Functional System

Group	Typical Products	Points
Level 1 (Base Group)	<u>Typical products:</u> Levelling base, floor screed, waterproofing	1
Level 2 (Finishes Group)	<u>Typical products:</u> <ul style="list-style-type: none"> • Raised floor systems (Insulation, underlay, carpets/ carpet tiles/ vinyl/ laminate/ tile/ timber to the floor panel) • Floor finishes including underlays, coatings, grouting, pointing, skirting, adhesives, carpets, vinyl, tiles, laminate flooring, timber flooring, marble flooring etc. 	2

Notes:
Where a product is not required for use within the grouping, it may be considered to have met the requirement.
Excludes structural floor slab
The points score is as shown above when assessment is for the whole building. The distribution of points will be lower if the project excludes dwelling units i.e. only common areas are to be scored

Table 3.2c-4 – Ceiling Functional System

Group	Typical Products	Points
Level 1 (Base Group)	<u>Typical products:</u> Bare soffit of slab above, plastering, skim coat <i>(Note where the ceiling is an off form soffit finish, it is deemed to comply)</i>	0.5
Level 2 (Finishes Group)	<u>Typical products:</u> Ceiling boards (excluding framing, fixing and bracing), insulation adhesives, paint finish, coatings <i>Note where the ceiling is an off form finish (no false ceiling, no plastering, this is deemed to comply)</i>	0.5

Note:
Where a product is not required for use within the grouping, it may be considered to have met the requirement.
Excludes structural slabs ceiling slabs
The points score is as shown above when assessment is for the whole building. The distribution of points will be lower if the project excludes dwelling units; i.e. only common areas are to be scored

Table 3.2c-5 – Roof Functional System

Group	Typical Products	Points
Level 1 (Base Group)	<u>Typical products:</u> <ul style="list-style-type: none"> For RC flat roofs: Levelling base, screed, waterproofing, insulation For Framed Roof: Waterproofing, insulation (excluding structural frame) 	0.5
Level 2 (Finishes Group)	<u>Typical products:</u> All finishes including metal sheets, roof tiles, tile grouts, tiles, paints and coatings, adhesives, pointing, skirting	0.5

Notes:
 Where a product is not required for use within the grouping, it may be considered to have met the requirement.
 Excludes structural roof slabs/ framing. The Roofing Functional System only includes products above/ interspersed between the structural slab / frame of the roof.
 The area is to be taken in totality. For roof, the area will be the actual area of the roof at inclination.

Table 3.2c-6 – External Wall Functional System

Group	Typical Products	Points
Level 1 (Base Group)	<u>Typical products:</u> Curtain wall, integrated wall system, wall panels, blocks, metal cladding, waterproofing, sealant, adhesives, jointing, grouting, pointing, (fixing brackets may be excluded)	1
Level 2 (Finishes Group)	<u>Typical products:</u> <ul style="list-style-type: none"> All external face finishes (both sides) including skim coats, external paints (including primers), external coatings, corner beads, corner protectors All internal face finishes (both sides) including skim coat, internal paint, corner beads, corner protectors, fabrics, wall papers, wall tiles etc. 	2

Notes:
 Where a product is not required for use within the grouping, it may be considered to have met the requirement.
 Excludes structural walls, external architectural aesthetic features and openings.
 Area is taken on both sides of the walls.

Table 3.2c-7 – Internal Wall Functional System

Group	Typical Products	Points
Level 1 (Base Group)	<u>Typical products:</u> Lightweight wall panels, drywalls, blocks, waterproofing, jointing, wall grouting, boarding insulation (fixing frame may be excluded)	1
Level 2 (Finishes Group)	<u>Typical products:</u> All finishes (both sides) including plastering, skim coat, corner beads, corner protectors, fabrics, wall papers, wall tiles, tiles grouting vinyl, laminates, veneers, adhesives, paint etc.	2

Notes:
 Where a product is not required for use within the grouping, it may be considered to have met the requirement.
 Areas are taken on both sides of the walls.
 The points score is as shown above when assessment is for the whole building. The distribution of points will be lower if the project excludes dwelling units; i.e. only common areas are to be scored

Table 3.2c-8 – Door Functional System

Group	Typical Products	Points
Level 1 (Base Group)	<u>Typical products:</u> Glass door, door leaf, door finishes including laminates, paint and veneers/ vinyl sheets, varnish, coatings	1
Level 2 (Finishes Group)	<u>Typical products:</u> Door accessories, either; i) door frame, door frame finishes, ii) ironmongery	0.5

Notes:

Where a product is not required for use within the grouping, it may be considered to have met the requirement.

The Finishes Group here refer to the door accessories and not the door finishes.

The points score is as shown above when assessment is for the whole building. The distribution of points will be lower if the project excludes dwelling units; i.e. only common areas are to be scored

Assessment Notes

Please note that the areas are to be taken in totality. For walls, the level 2 will include area on 2 faces of the wall. For roof, the area will be the actual area of the roof at inclination.

Worked Example

Example 1

This is the ceiling of a single storey building, Building A, inclusive dwelling units.

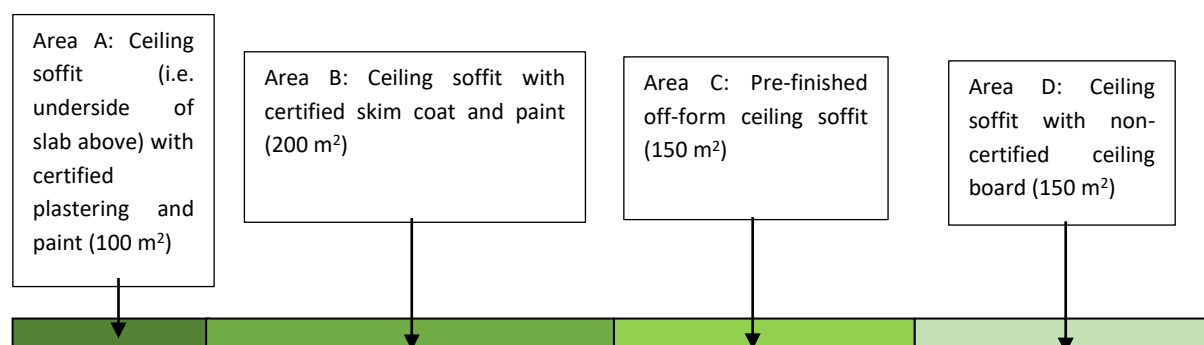

Tabulating the areas for Ceiling Functional System, bearing in mind structural items are excluded:

Area	Applicable items under Base Group	Applicable items under Finishes Group
A (100m ²)	Certified plastering	Certified paint
B (200m ²)	Certified skim coat	Certified paint
C (150m ²)	No additional product required	No additional product required
D (150m ²)	No additional product required	Non-certified ceiling board

Total area that considered meet requirement	All areas meet requirement (100%)	Areas A, B and C meet the requirement. Coverage = $\frac{100+200+150}{100+200+150+150} = 75.0\%$
Points	As Base Group coverage is > 60%, 0.5 point can be scored.	As Base Group coverage is >60% including dwelling units, project is eligible to score for Finishes Group. As area coverage for certified finishes under Finishes Group > 60%, points scored for Finishes Group = 0.5 point.
Total points for Ceiling Functional System = 1 point.		

Example 2

This is the internal walls of a single storey building, Building B. Area D shows dwelling units' spaces.

Area A: Block panel walls with waterproofing, jointing, grouting, plastering, skim coat, corner beads, finishing paint on both sides. Everything is certified except for the corner beads (150 m²)

Area B: Lightweight panels party wall with waterproofing, jointing, grouting, tiled finish on one side and plastering and paint on the other side. Everything is certified except for the tiled finish (80 m²)

Area C: Drywalls with boarding and insulation (excluding fixing frame). Finishing paint on one side. The other side is not painted. Everything is certified (50 m²)



Area D: Space in Dwelling unit. Unknown what partitions home owner may install and it was not included in sales agreement (Partition walls in dwelling units are unknown)

Tabulating the areas for Internal Wall Functional System, bearing in mind structural items are excluded:

Area	Applicable items under Base Group	Applicable items under Finishes Group
A (150 m ²)	Block panel walls with waterproofing, jointing, grouting. All are certified.	Plastering, skim coat, corner beads, finishing paint on both sides. Everything is certified, except for the corner beads. <i>Note: For this example, corner beads were included in the design and specification of finishes selection hence is include in the evaluation.</i>
B (80 m ²)	Lightweight panels party wall with waterproofing, jointing, grouting. All are certified.	Non-certified tiled finish on one side and certified paint on the other side. All plastering used is certified.
C (50 m ²)	Drywalls with boarding and insulation (excluding fixing frame). Everything is certified.	Certified finishing paint on one side. The other side is not required to be painted hence is deemed to comply.
D (Unknown)	Unknown	Unknown
Total area that considered meet requirement	Areas A, B and C meet requirement. Coverage excluding tenanted area = 100%	One face of Area B and both faces of Area C meet requirement. Coverage excluding tenanted area= $\frac{80+(50 \times 2)}{(150 \times 2)+(80 \times 2)+(50 \times 2)} = 32\%$

Points	Project chooses to score using the table on excluding dwelling units. In Base Group, all walls are certified, hence, Base Group coverage is $\geq 80\%$, points can be scored =0.5pt	As Base Group coverage is $\geq 80\%$ excluding dwelling units, project is eligible to score for Finishes Group. However, as area coverage for certified finishes under Finishes Group $< 80\%$, points scored for Finishes Group = 0 point
	Total points for Internal Wall Functional System = 0.5 point.	

Example 3

Building C includes all dwelling units in its design and specifications. The points are computed as follows:

Description	All Certified Products?	Coverage	% of Functional System	Green Mark Points Achieved
Internal Wall Functional System				
Coverage: All internal wall of development including balconies with finishes (5,000 m ²)				
<i>Base Group</i>				
1. Block and panel walls (Includes waterproofing, jointing, wall grouting)	Yes	100 m ²	2%	1 point (100% of area is green certified)
2. Lightweight panel party walls (Includes waterproofing, jointing, wall grouting)	Yes	800 m ²	16%	
3. Lightweight panels for wet areas (Includes waterproofing, jointing, wall grouting)	Yes	250 m ²	8%	
4. Lightweight panel walls for back of house and services, plant rooms (Includes waterproofing, jointing, grouting)	Yes	150 m ²		
5. Drywalls for all dwelling units (Includes boarding, insulation. Excludes fixing frame)	Yes	3,700 m ²	74%	
<i>Finishes Group</i>				
1. Block and panel walls: C cement plastering, corner beads, and corner protectors where applicable; excludes fixing brackets) and finished with paint on both sides	Yes	100 m ²	2%	2 points (97.5% of area is green certified)
2. On lightweight panels party walls: Combination of cement plastering & skim coat, corner beads, and corner protectors where applicable, excludes fixing brackets) and finished with paint on both sides	Yes	800 m ²	16%	
3. Lightweight panels in dwelling units' wet areas: Non-certified tiled finish on one side of the lightweight panels in tenants' wet areas, and with certified plastering and painted finish on another side	Yes (partial)	125 m ² out of 250 m ² (only half face of wall qualifies)	2.5%	
4. Lightweight panel walls for back of house and services, plant rooms; Cement plastering with paint finish on one side and bare finish (no finishing) on the other side	Yes	150 m ² (bare finish or no finish; 2nd level may be consider as	3%	

		<i>meeting requirement)</i>		
5. Finishing paint on both sides of the drywalls for all dwelling units	Yes	3,700 m ²	74%	

Description	All Certified Products?	Coverage	% of Functional System	Green Mark Points Achieved
Flooring Functional System				
Coverage: All floors of development including balconies with finishes (2,500 m ²)				
<i>Base Group</i>				
1. Floor of circulation spaces and dwelling units: Floor screed	Yes	1,900 m ²	76%	1 point (100%)
2. Floor screed and waterproofing in wet areas	Yes	500 m ²	20%	
3. Floor of service area: Floor screed	Yes	100 m ²	4%	
<i>Finishes Group</i>				
1. Floor of circulation spaces: Certified floor tiles and grouting	Yes	700 m ²	28%	2 points (88%)
2. Floor of tenants' spaces: Combination of certified timber flooring and adhesives and final coating, non-certified marble flooring	Yes	<i>Certified: 900 m² out of 1200 m²</i>	36%	
3. Floor of wet areas: Certified floor tiles and grouting	Yes	500 m ²	20%	
4. Floor of service area: No finish (i.e. cement screed finish)	Yes	100 m ²	4%	

Description	All Certified Products?	Coverage	% of Functional System	Green Mark Points Achieved
Door Functional System				
Coverage: All doors of development (100 nos.)				
<i>Base Group</i>				
1. Doors to service spaces: Non-certified timber hollow core and certified low VOC paint system (include basecoat and final coats)	No	9	91 nos.	1 point (91%)
2. Doors to units: Certified timber fire rated doors with certified veneer and finishing coats	Yes	85		
3. Other doors: Certified glass door with no finish required	Yes	6		
<i>Finishes Group (Door Accessories)</i>				
1. Doors to service spaces: Certified door frame with certified low VOC paint finish for the frame	Yes	9 <i>(not eligible because 1st level base is not a certified products)</i>	81 nos.	0.5 points (81%)

a)	Door to dwelling units: Certified door frame with certified veneer and finishing coats	Yes	75		
b)	Doors to dwelling units: Certified door frame with non-certified veneer for frame	No	5		
2.	Other doors: No frame required	NA	6		

3.2c (ii) Singular Sustainable Products outside of Functional Systems

Intent

To encourage the use of sustainable products that do not fall into the functional systems in 3.2c (i)

Assessment

Up to 2 points can be scored for the use of sustainable products certified by an approved local certification body in the following categories.

The maximum points achievable for products under the functional system and singular components is 8 points (combined). These include items such as:

Category	Description
Hardscape	<ul style="list-style-type: none"> •Water drainage products: Drains, gratings, drainpipe, culvert, rainwater collection tanks •Landscape products: Drainage cells, green wall/ roof planting system, man-made grass, slope retainers, certified termite treatment, certified swimming pool/ pond water treatment •Pedestrian and vehicular products: Pavers, road humps, wheel stoppers, road kerbs •Community leisure products: Playground equipment, fitness/ playground flooring, decking, outdoor furniture, etc.
Building Services	<ul style="list-style-type: none"> •Mechanical and Electrical products: Chillers, transformers, switchboards, pumps, fans, motors; sensors, distribution boards, electrical energy storage system (typically used storing for renewable energy) •Firefighting products •Plumbing and sewerage products: Piping and joints, inspection chambers •Other building products: Shading devices, light (sun) pipes, connectivity, cabling, ducting, toilet partitions, workstations

0.25 points for each product used for $\geq 80\%$ of the applicable use

Guidance Notes

The sustainable products claimable under singular product should not be that already being used in functional system in 3.2c (i).

Coverage of used should be $\geq 80\%$ of the applicable function of the singular product type; such as the landscape could use a combination of brands and model of certified products to make out $\geq 80\%$.

Scenario 1, if there are 3 types of timber deck used, the combined usage should have a coverage of $\geq 80\%$; in such case the score is 0.25 points.

Scenario 2, if the 1 type of timber was used and covering $\geq 80\%$ of usage; the score is 0.25 points.

Documentary Evidences

At Design Stage:

Extracts from the tender specification and drawings showing the requirements to incorporate the environmentally friendly products that are certified by the approved local certification body.

Tabulation of all the functional systems in totality; this shall include those not using certified products. This is to allow assessor to acquire the confirmation of the extent of the coverage of the use of building products for the building in totality.

The table shall include all respective construction method statements (1 type or combination of type of finishes), respective area coverage, list of corresponding certified products used and corresponding tick rating of the certified product.

Verification (As Built):

- As built drawings showing the extent of use of green products within the functional systems
- Delivery orders of products with their corresponding green product certificates

Worked Example

Example 1

Project X has drainage cells and timber desk with green certification.

Therefore, points scored for 3.2c (ii) = $0.25 \times 2 = 0.5$ points. Where a project scores use of products in both the functional system and singular components, the point cap is 8 points. An additional, 0.25 to 1 bonus point can be scored under for the Use of SGBP higher rating products (Advanced Green Effort). Bonus for Advanced Green Effort is cap at 2 points.

SGBP Products Rated Very Good or Above (Advanced Green Effort)

Intent

To encourage the use of products with a very good rating (2 ticks) or above under the Singapore Green Building Product (SGBP) certification scheme.

Assessment

Up to 2 points can be scored for the use of Very Good or higher rated products within the project. These products can form part of the functional systems or be standalone products scored under 3.2(ii)

SGBP Rating	Points per product (≥ 90% of the applicable use)
Very Good (2-ticks)	0.25
Excellent (3-ticks)	0.5
Leader (4-ticks)	1

0.25 points for each product used for ≥ 90% of the applicable use

Guidance Notes

At Design Stage:

Points per product and ≥ 90% of the applicable use can be defined for example as 90% of all ceiling boards within a development shall be certified to SGBP Very Good or higher. These can be through a range of different brands.

Where a mix of ratings is used (e.g. waterproof screed), the lowest rating shall be used to calculate the score.

Documentary evidence:

- Extracts from the tender specification and drawings showing the requirements to incorporate the environmentally friendly products that are certified by the approved local certification body
- Product certificates

Verification (As Built):

- As built drawings showing the extent of use of green products within the functional systems
- Delivery orders of products with their corresponding green product certificates

3.3 Waste



Responsible management of waste is an essential aspect of sustainable construction and building operation. To minimise waste generation, it is crucial to use resources (other than building materials) consumed during the construction process efficiently, as well as to provide adequate facilities and systems to manage waste during building operation.

Criteria	Points
3.3a Environmental Construction Management Plan	1
3.3b Operational Waste Management	3
TOTAL	4

3.3a Environmental Construction Management Plan

Intent

An effective and holistic management plan can facilitate better environmental performance of the construction process and promote waste minimisation.

Scope

Applicable to building construction activities.

Assessment

1 point can be scored for effective implementation of an environmental construction management plan through specific target settings, monitoring of energy and water use and waste minimisation measures.

Guidance Notes

The environmental construction management plan should contain the following:

- **Energy Targets:** Total energy consumption target set for the construction which includes the quantity of diesel, electricity from the grid (kWh)
 - The benchmark should be normalised to the building GFA to facilitate future benchmarking for projects
 - Detailed recommendations for on-site energy management strategies
- **Water Targets:** Total water consumption target set for the construction in m³
 - The benchmark should be normalised to building GFA to facilitate future benchmarking for projects
 - Detailed recommendations for on-site water management strategies
- **Waste Targets:** Dominant waste streams and means of collection and recycling
 - The benchmark to reduce construction waste shall be established as waste (kg)/GFA (m²) of building
 - The waste recycling rate shall be established as percentage of waste diverted from landfill or incineration plant
- **Monitoring and Reporting Method:** Monitoring and measurement procedures for the usage of resources, waste and recycled streams on site, and how the targets are tracked, monitored and reported to ensure effective implementation of the environmental construction management plan

Documentary Evidences

At Design Stage:

- Submission of the environmental construction management plan that would be implemented on site which should include definitive energy, water and waste target set for the construction.

Verification (As Built):

- Submission of the environmental construction management plan with written narrative of the overall environmental performance and resource usages during construction as well as measures taken to rectify any abnormality in resource usages where applicable.
- Detailed charts showing the actual energy, water and waste monitoring and trending data against the benchmarks set at design stage as well as detailed records of the waste volume that were sent to the relevant approved recyclers are to be included.

3.3b Operational Waste Management

Scope

Appropriate collection and recycling facilities can help the segregation of recyclable consumer waste at source and the treatment of horticultural or wood waste for reuse and recycling.

Assessment

Criteria	Points
(i) Recycling facilities in common areas	1
(ii) Facilities for storage and composting of horticultural waste	1
(iii) Website dashboard or other platform on recycling efforts	1

1 point each can be scored for the provision of the following:

- (i) Facilities for the collection and storage of different recyclables such as paper, glass, metal and plastic in commingled or sorted form in common areas.
- (ii) Facilities or systems for the placement of horticultural or wood waste for recycling.
- (iii) Website dashboard or other visible platform which promote participation and recycling efforts. It should comprise sharing of valuable information with residents about acceptable recyclable materials, report on recycling achievement and contribution to the environment.

The recycling facilities or systems provided should be located at the convenience of use.

Guidance Notes

At Design Stage:

- Plan layout showing the location of the recycling facilities for collection and storage of the relevant recyclables including horticultural wastes where applicable.

Verification (As-Built):

- As-built plans and photographs showing the location of actual recycling facilities for collection and storage of the relevant recyclables including horticultural wastes where applicable
- Contractual arrangement with waste collection vendors for offsite recycling where applicable
- On-site photographs of recycling facilities installed.

4. Smart and Healthy Building



Most of us spend a substantial proportion of our time within buildings, where we are psychologically, physiologically and emotionally affected by our surrounding environment. Aspects of a healthy indoor environment include better air quality, effective daylighting, quality artificial lighting, pleasant acoustics, inclusivity as well as biophilic design features that evokes the experience of nature.

Designing for healthy buildings can be a sound economic investment that reaps healthy economic returns, with measures to improve the indoor environment leading to manifold monetary savings from improved health and well-being. A healing, positive environment nurtures healthier and happier occupants. In spaces where people work and study, this can result in increased work quality and productivity output.

Smart controls and direct access to consumption data allow the facility management team and occupants to gain a good understanding of the systems and usage patterns.

P.13 Prerequisites

Criteria	Points
4.1 Indoor Air Quality	8
4.2 Spatial Quality	9
4.3 Smart Building Operations	8
TOTAL	25
Advanced Green Effort	5

P.13 Low Volatile Organic Compound (VOC) Paints

Intent

To limit the use of high VOC emitting building and furnishing materials to improve indoor air quality for the health and well-being of occupants.

Scope

Applicable to all indoor paints including primers, sealers, base coats and top coats.

Assessment

Low VOC paints certified by an approved local certification body shall be used for at least 90% of the total painted internal wall areas.

Documentary Evidences

At Design Stage:

Submission of the following:

- Extracts of the tender specification showing the requirement to use low VOC paints that are certified by an approved local certification body.
- Certification details from approved local certification body.
- Technical product information and delivery records.

Verification (As Built):

Submission of purchase orders and delivery orders of the indoor paints used.



4.1 Indoor Air Quality

To ensure good air quality within residential building functional spaces where occupants are expected to remain in for an extended period of time. Most of us spend a substantial proportion of our time within buildings. Given this it is important to provide healthy indoor environments that reduce the risk of illnesses which affects not only the productivity of the business, but more importantly the wellbeing of the occupants.

Criteria	Points
4.1a Occupant Comfort	2
4.1b Contaminants	6
TOTAL	8
Advanced Green Effort – 5.1h Outdoor Air	2

4.1a Occupant Comfort

Intent

The provision good indoor air quality parameters are crucial to ensure occupant comfort. Besides using energy intensive air-conditioners, occupant comfort can also be achieved by improving ventilation or other air quality parameters in the event that prevailing winds are unavailable. The criteria encourage innovation and measures to improve occupant comfort without adopting energy intensive options.

Scope

Applicable to occupant residential spaces – living rooms and bedrooms.

Assessment

Criteria	Points
Occupant Comfort	2

Up to 2 points can be scored for provision of assisted mechanism to achieve thermal comfort for occupant residential spaces

- For living room only - 1 point
- For all living room, bedrooms – 2 points

Documentary Evidences

At Design Stage:

Submission of the following:

- Architectural elevation drawings showing the provision of assisted mechanism equipment.
- Extracts of the tender specification or material schedules showing the properties of assisted mechanism equipment.

Verification (As Built):

Submission of the following:

- Purchase orders/ delivery orders of the assisted mechanism equipment.
- Visual checks on the assisted mechanism equipment.

Worked Example

Example 1

Provision of ceiling fans in living rooms only = 1 point

Example 2

Provision of wall-hung fans in living rooms and ceiling fans in all bedrooms = 2 points

4.1b Contaminants

Intent

To encourage the use of interior fit out and finishes that safeguard the occupant's health through the reduction of the emission of harmful volatile organic compounds (VOC's).

Scope

Applicable to residential units only.

Assessment

Criteria	Points
i) More Stringent VOC Limits for Interior Fittings and Finishes	3
ii) Waste Disposal	1
iii) Indoor Air Quality in Wet Areas	2

i) More Stringent VOC Limits for Interior Fittings and Finishes

Use of low VOC emitting interior finishes that are certified by approved local certification bodies.

- Adhesives & sealants (including tile grouting)
- Floor coverings such as carpets, laminates and vinyl flooring (excluding tiles)
- Ceiling coverings such as ceiling boards,
- Wall coverings (excluding tiles)
- Varnish, stains, lacquers or other trims (including doors and furniture)

1 point for one main category of finishes (excluding tiles) for $\geq 90\%$ of applicable areas.

3 points for all finishes for $\geq 90\%$ of applicable areas

ii) Waste Disposal

1 point can be scored by locating refuse chutes or waste disposal area at open ventilated areas such as service balconies or common corridors.

iii) Indoor Air Quality in Wet Areas

Up to 2 points can be scored with provision of adequate natural ventilation and daylighting in wet areas such as kitchens, bathrooms and toilets. Fumes from stove(s) should be adequately ventilated to exterior, instead of spreading to other occupied spaces.

Points scored based on the % of applicable areas with such provision:

- 1 point for 50% to 90% of applicable areas
- 2 points for $\geq 90\%$ of applicable areas

Documentary Evidences

At Design Stage:

Submission of the following:

- i) More Stringent VOC Limits for Interior Fittings and Finishes
 - As built drawings and calculation of the use of certified low VOC emitting products
 - Product certificates
- ii) Waste Disposal
 - As built drawings of location of refuse chutes or waste disposal area at open ventilated areas
- iii) Indoor Air Quality in Wet Areas
 - As built drawings and calculation of % of applicable areas adequate natural ventilation and daylighting in wet areas

Verification (As Built):

Submission of the following:

- iv) More Stringent VOC Limits for Interior Fittings and Finishes
 - Purchase orders (POs)/Delivery Orders (DOs) of the products
 - Visual checks on provision of such provision
- v) Waste Disposal
 - Visual checks on provision of such provision
- vi) Indoor Air Quality in Wet Areas
 - Visual checks on provision of such provision

Worked Example

Example 1

Having low VOC emitting interior finishes, approved local certification bodies, for

- 95% of adhesives & sealants (including tile grouting);
- 90% of applicable floor coverings such as carpets, laminates and vinyl flooring (excluding tiles); and
- 50% of varnish, stains, lacquers or other trims (including doors and furniture)

Point scored = 1 point

Having refuse chutes or waste disposal areas at open ventilated areas for 80% of the units = 1 point

Example 2

Having low VOC emitting interior finishes, approved local certification bodies, for

- 90% of adhesives & sealants (including tile grouting);
- 90% of applicable floor coverings such as carpets, laminates and vinyl flooring (excluding tiles);
- 90% of applicable wall coverings (excluding tiles); and

Point scored = 3 points

Having refuse chutes or waste disposal areas at open ventilated areas for only 50% of the units = 0 point

Example 3

2 points for achieving:-

- 90% of wet areas having adequate natural ventilation and daylighting
- Stoves is located 3m from windows and it is adequately ventilated to exterior

Example 4

1 point for achieving:-

- 95% of wet areas having adequate daylighting but only 80% of wet areas having adequate natural ventilation
- Stoves is located 2.5m from windows and it is adequately ventilated to exterior

Example 5

0 point for achieving:-

- 100% of wet areas having adequate daylighting but only 45% of wet areas having adequate natural ventilation
- Stoves is located 7m from windows and will have fumes spreading to living room due to open concept design

5.1i Outdoor Air (Advanced Green Efforts)

Intent

Provision of a space/room in the unit with minimum outdoor air in occupant space when windows are closed, particularly in scenario when there is poor outdoor air quality condition

Assessment

2 points for the provision of clean outdoor air supply at 0.3 l/s per m² floor area.
0.5 point for the provision of portable air cleaner for every unit.

Documentary Evidences

Drawing showing the provision of clean outdoor air supply with description.

At Design Stage:

Submission of the following:

- Equipment specification of fan system with filters or technical specification of portable air cleaner
- Calculation on the outdoor air supply rate

Verification (As Built):

Submission of the following:

- Visual checks on provision of element

Worked Example

Example 1

Provision of clean outdoor air supply at 0.3 l/s per m² floor area (2 points)
Provision of portable air cleaner for every unit (0.5 point)

Total point score = 2 points (capped at 2 points)

Example 2

Provision of portable air cleaner for every unit (0.5 point)

4.2 Spatial Quality



The spatial quality of a building is assessed through the experiential value of both the physical and social qualities of the spaces within the development. Although many spatial quality indicators are qualitative, there are a number of commonly agreed upon indicators that act as a reliable proxy to determine the projects spatial quality which can enhance the indoor environment and wellbeing of the occupants and visitors to the building. These include creating access to quality daylight and artificial lighting, ensuring spaces are acoustically comfortable and inclusive as well as incorporating design features that evoke a connection to nature.

Criteria	Points
4.2a Lighting	5
4.2b Acoustics	2
4.2c Wellbeing	2
TOTAL	9
Advanced Green Efforts	1

4.2a Lighting

Intent

The quality of the lighting in a building is important to provide well-lit and comfortable spaces for the building occupants and users.

Daylight provides delight to occupants and has been linked to positive mental wellbeing leading to improved productivity of building occupants. A well-designed daylit building also reduces reliance on artificial lighting during the day. In addition, integrating suitable electric lighting controls reduces the use of artificial lighting when daylight is sufficient and has a high potential to reduce power intensity, internal loads, and energy consumption of the building. Green Mark 2016 strives to encourage designers to incorporate effective daylight design strategies from the beginning of the design process.

Scope

Applicable to residential units only.

Assessment

Criteria	Points
(i) Effective Daylighting	5

4.2a (i) Effective Daylighting

Intent

To encourage effective daylighting, points are awarded based on the effectiveness of implementation of design for daylighting in buildings. There are two areas where daylight can be incorporated: in common areas (transient spaces) and in residential units (which occupants use for longer periods of time).

Assessment

Points shall be awarded based on the following options:

Criteria	Points
Daylighting for common areas	Up to 1.5 points
Daylighting for occupied spaces	Up to 3.5 points

Effective daylighting for common areas

Up to 1.5 points shall be awarded by number of all common spaces with daylighting.

The requirement is met where the common spaces are designed with openings or fenestration to the exterior. The distance of penetration should be within 2 times the height of the opening or fenestration.

Common Area	Points
Staircases	0.5 point each prorated by numbers
Corridors & Lift Lobbies	
Car parks	
Total	1.5 (cap)

Effective daylighting for Residential Units

The criteria provide two methods to compute effective daylighting; using the simplified pre-computed daylight availability area table for standard design referencing to the Pre-Simulated Daylight Availability Tables Methodology and the Performance-based method using Daylight Simulation for non-standard design.

The criteria adopt annual climate-based daylighting metrics in its evaluation of effective daylighting. There are two measures considered in the daylight appraisal, daylight autonomy (DA) and Useful Daylight Illuminance (UDI).

Daylit area is defined as the room depth measured from the facade achieving the stated lighting requirement for 50% of the occupied hour range (as defined in Table 1) throughout the entire year. This percent of time a desired lighting level can be achieved from daylight alone is referred to as daylight autonomy (DA), and the combination of illuminance and percent time daylit area criteria can be abbreviated as $DA_{N \text{ lx}, 50\%}$ where N is the illuminance requirement in lux for a specific space program and the 50% represents the fraction of occupied time lighting criteria are met in full by daylight.

There is an upper limit to the illuminance in lux that is acceptable. Visual discomfort is more likely to occur in areas which receive a lighting level of at least 3000 lx for 10% of the occupied hour range throughout the year. Percentages of time over this 3000 lx threshold, which are likely to indicate increased probability of visual discomfort or glare, is called Useful Daylight Illuminance Exceeded (UDIE). These visual discomfort criteria can be abbreviated $UDIE_{3000 \text{ lx}, 10\%}$.

The visual discomfort in this requirement is defined as a phenomenon caused by high illuminances, typically due to direct sunlight. The incidence of glare coming from the sun at low angle during the early morning and evening, which is usually overcome by occupants' controlled blinds and may not illuminate working surfaces directly, is not addressed in this criteria.

Important note: To ensure daylight design is deployed to reap the best benefit; it is good practice to incorporate integrated artificial lighting circuitry design.

Using the Pre-Simulated Daylight Availability Tables Methodology (Simplified Pre-computed Method for Standard Designs)

Refer to Appendix A for the Pre-Simulated Daylight Availability Tables Methodology using the appropriate criteria including illuminance requirements, building orientation, urban context, window-to-wall ratio, glazing visible transmittance and shading devices.

The Pre-Simulated Daylight Availability Tables Methodology is derived from a study with Singapore University of Technology and Design (SUTD) using a reference model (shoe box) to provide close to 13,000 pre-simulated results to form useful daylight penetration depth matrix for spaces with floor-

to-ceiling heights ranging between 2.5 to 3.1 m. The matrix serves as a useful tool during conceptual design explorations.

There are several limitations to Pre-Simulated Daylight Availability Tables Methodology that should be considered when using them on a Green Mark project.

Potential Underestimating Lighting in Spaces with More than One Glazed Façade; the day lit area in the Pre-Simulated Daylight Availability Tables Methodology is for single-sided lit spaces; however, in spaces with windows on two opposing facades, the depth of daylight penetration would naturally increase due to contributions from opposing sides of the space. Such cases may wish to consider using a full simulation in order to increase their daylit area.

Potential for Double Counting; following directly from the above case, if two glazed facades are located about a single corner, the daylit areas will overlap. The total daylit area in these cases should be calculated using a floor plan drawing in order to avoid double-counting daylight portions of a space.

Lighting in Spaces with high ceilings; the day lit area in the Pre-Simulated Daylight Availability Tables Methodology is for spaces with ceiling height ranging from 2.5 to 3.1m; however, in spaces with a higher ceiling, the depth of daylight penetration may change. Such cases may wish to consider using a full simulation in order to show the day lit area more accurately.

Table 1

Functional Spaces and Daylight Autonomy requirement	Total area with achieved daylighting , where DA is achieved without presence of glare; in percentage of the total occupied spaces	Where Glare mitigation strategies are deployed to at least 90% of the applicable area with potential for or risk of overlighting
---	---	--

<p>Residential @ DA200 lx of at least 50% and UDle3000 lx of less than 10% from 7:00 AM to 10:00AM and 4:00 PM to 7:00PM. (Refer Annex B)</p>		<p>2 level of scores, prorated across two levels are allowed</p> <p>Up to 3points for Exemplary Daylit Dwelling Design OR Up to 2 points for Acceptable Daylit Dwelling Design</p>	<p>0.5 point</p> <p><u>For Pre-Simulated Daylight Availability Tables Methodology</u>; this can be shown by the use of suitable effective overlighting mitigation strategies listed integrated with automated control responding to the change in daylight conditions.</p> <p><u>For Daylight simulation method</u>; the use of Dynamic Shading Systems is to be incorporated into the simulation to show that visual discomfort is mitigated in spaces which encounters Potential or Risk of overlighting.</p>
---	--	--	---

For Exemplary Daylit Dwelling Design

Each Residential units (in bedrooms, living room, family room and study room) to meet DA_{200lux}, 50% minimum in 75% of applicable area to qualify in the count of number of residential units are daylit.

$$\frac{\text{Total Residential Units meet the daylit requirement}}{\text{Total Number of Units}} \times 100\% \times 3 \text{ points}$$

For acceptable Daylit Dwelling Design

Each Residential units (in bedrooms, living room, family room and study room) to meet DA_{200lux}, 50% minimum in 60% of applicable area to qualify in the count of number of residential units are daylit.

$$\frac{\text{Total Residential Units meet the daylit requirement}}{\text{Total Number of Units}} \times 100\% \times 2 \text{ points}$$

Using Performance method with full Simulation

The report from the simulation results to show the result of the availability of daylight coverage to score points and identifying the presence of glare.

Overlighting mitigation is to be included into the simulation model to show the effectiveness of the strategy to mitigate glare.

Refer to Annex B for the methodology and guidelines for full daylight simulation.

Guidance Notes

At Design Stage:

Submission of the following:

Daylight in common area:

Tabulation of all applicable daylit area calculations and layout on drawings that show that openings / fenestrations provided to daylit the space as derived from [Table 1]. The distance of daylit penetration from the façade and the height of the opening / fenestration are to be communicated as described in the effective daylighting for occupied spaces subsection.

Daylight Performance using deemed to comply method:

Tabulation of all applicable occupied areas and calculations using the appropriate Daylit Area Matrix. Drawings are to be used to illustrate daylit areas. The tabulation should also identify areas with and without overlighting. Where there are areas identified with potential for or risk of overlighting, the area is to be excluded from contributions to the daylit area unless mitigation strategies are employed as per Annex B.

Full Daylight Simulation

A daylight modelling report including Daylight Autonomy and Useful Daylight Illuminance Exceeded results showing the effective daylight for the representative functional spaces in compliance with the requirements in the *BCA Green Mark Daylighting Simulation Guidelines*.

Verification (As Built):

Submission of the following:

Daylight

As built drawings of the façade and layouts of the functional spaces. Performance spot measurements of the effective daylighting through lux measurements and photographs of the applicable functional spaces.

Overlighting mitigation strategies

Delivery orders and photographs to show mitigation strategies are implemented.

4.2b Acoustics

Intent

To provide a peaceful environment for residential occupant and to encourage developers to consider acoustics parameters during design stage.

Scope

Applicable to occupied spaces of residential units.

Assessment

Criteria	Points
(i) Acoustics Planning	1
(ii) Acoustics Design	1

i) Acoustics Planning

1 point for architectural design to avoid windows of living rooms and bedrooms to be in immediate proximity/facing to noise sources within site boundary and 70 metres away from site boundary perimeter.

Noise sources include:

- 3) Category 1 and category 2 road
- 4) MRT tracks and stations

ii) Acoustics Design

1 point for acoustic design report meeting relevant authority's requirement with an aggregate area of not less than 10% of the room/space to be ventilated. Credit is given for implementation of recommendations stated in the report to meet acoustic requirement.

Documentary Evidences

Drawing showing the architectural design to avoid windows of living rooms and bedrooms to be in immediate proximity/facing to noise sources within site boundary and 70 metres away from site boundary perimeter.

At Design Stage:

Submission of the following:

- Architectural elevation drawings showing location of windows of living rooms and bedrooms and distance from noise source

Verification (As Built):

Submission of the following:

- Visual checks on provision of such avoidance.

Worked Example

Example 1

Having windows facing noise source that is 80 m away = 1 point

Example 2

Having windows facing noise source that is 50 m away = 0 point

Acoustic design report meeting relevant authority's requirement with an aggregate area of not less than 10% of the room/space to be ventilated = 1 point

4.2c Wellbeing

Intent

To provide living environment that provide good wellbeing for the resident, bond to nature and promote accessibility.

Scope

Applicable to design of residential developments and its common areas.

Assessment

Criteria	Points
(i) Biophilic Design	2
(ii) Universal Design Mark	1
Total	3
Advanced Green Effort – 5.4 Social Benefits	1

i) Biophilic Design

Up to 1 point can be scored for including elements of nature in comfortable spaces to nurture the human-nature relationship is important for the health and happiness of the building users. We see the value of greenery in improving our quality of life. This indicator aims to facilitate even more accessible greenery to further enhance the building occupant and user's environment, and overall wellbeing.

0.15 point shall be award per elements/features from the following:

Provision of elements of nature in common areas.

- a) Daylighting and natural ventilation
- b) Water features
- c) Extensive greenery (e.g. high GPR, roof gardens, green wall)
- d) Fauna, beyond insect species (e.g. birds, fish, amphibians, native wildlife)
- e) Natural landscape and ecosystems (e.g. eco-pond, natural planting with matured trees)

Provision of elements of indirect experience of nature in building design:

- a) Images of nature (e.g. paintings, wall stickers) – 1 image per 500 m² of common areas.
- b) Use of natural materials like wood and stone
- c) Use of natural colours
- d) Adoption of naturalistic shapes and forms (including plants and animals)
- e) Demonstrate the passage of time and age
- f) Use of natural geometrics including "Golden Ratio" and "Fibonacci Sequence"
- g) Adoption of biomimicry (such as big tree structure in Garden by the Bay)

Provision of features to facilitate experience of space and place:

- a) Design incorporating at least 2 distinct areas of prospect and refuge such as balconies, designated lookout areas along corridors
- b) Design incorporating organised complexity such as complicated patterned façade design
- c) Design incorporating integration of parts to wholes
- d) Provision of at least 3 different transitional environments between spaces such as sheltered walkway to car park, porches that link indoor to outdoor areas.
- e) Facilitate wayfinding in terms of locality and map provision in the whole development
- f) Designate as least 2 cultural defined locations

Provision of space in common areas for lifestyle wellbeing:

- a) Designated gardening/farming areas (e.g. community farming/gardening)
- b) Playground
- c) Fitness corner
- d) Dedicated running tracks with marked distance information
- e) Designated areas for wellness activities with peaceful ambience

Additional 1 point can be scored under Additional Green Effort –under 5.4 Social Benefits

ii) Universal Design Mark

The BCA UD Mark is a voluntary certification scheme launched in October 2012 as an initiative to accord recognition to developments and stakeholders that adopt a user-centric philosophy in their design, operations and maintenance. Points can be scored for projects that are awarded under the BCA UD Mark scheme as follows:

- UD Mark Certified or Gold Award – 0.5 point
- UD Mark Gold^{PLUS} or Platinum Award – 1 point

Worked Example

Example 1

Provision of 3 elements = 0.45 point

Example 2

Provision of 8 elements

With 6 element scored under 4.02b = $0.15 \times 6 = 0.9$ point (cap at 1 point)

and 2 element scored under 5.4 = $0.15 \times 2 = 0.3$ point (cap at 1 point)

Provision of Clean Outdoor Air (Advanced Green Efforts)

Intent

Provision of a space/room in the unit with minimum outdoor air in occupant space when windows are closed, particularly in when there is poor outdoor air quality condition

Assessment

Up to 2 points can be scored for provision of clean outdoor air:

- 2 points can be scored for provision of clean outdoor air at 3 l/s per m² floor area for that space/room
- 0.5 point can be scored for provision of portable air cleaner for every unit.

Documentary Evidences

Drawing showing the provision of clean outdoor air supply with description.

At Design Stage:

Submission of the following:

- Equipment specification of fan system with filters or technical specification of portable air cleaner
- Calculation on the outdoor air supply rate

Verification (As Built):

Submission of the following:

Visual checks on provision of element

Worked Example

Example 1

Provision of clean outdoor air supply at 0.3 l/s per m² floor area (2 points)

Provision of portable air cleaner for every unit (0.5 point)

Total point score = 2 points (capped at 2 points)

Example 2

Provision of portable air cleaner for every unit (0.5 point)



4.3 Smart Building Operations

The use of automation, data and behavioural science can enable building occupants to track their own energy use, allow building/development managers to optimise operation and maintenance procedures.

A three-level taxonomy is defined to classify the maturity of smartness as a framework, namely basic monitoring of data, using feedback from data to control demand, and finally advanced integration and analytics of data. Additionally, a proper handover to the facilities and operations team is of fundamental importance to ensure that the systems work as per their intended function and that sustainable design is translated into actual operational performance.

Criteria	Points
4.3a Energy Monitoring	2
4.3b Demand Control	2
4.3c Integration and Analytics	2
4.3d System Handover and Documentation	2
TOTAL	8
Advanced Green Efforts	2

4.3a Energy Monitoring

Intent

Tracking a building's energy use with the data presented in a relevant manner to engage its occupants to be involved in managing energy consumption. Related to this ideal of sharing building data openly is the need to apply open standards to future-proof the building's management system and to facilitate data exchange between subsystems.

Scope

Applicable to all residential buildings.

Assessment

(i) Energy Portal and Dashboard

0.5 point each can be scored for:

- The provision of a power meter with dashboard in the form of digital displays in common areas, or web-based and mobile applications
- The provision of a power meter with dashboard made available to residents / occupants, showing the energy consumption in their respective dwellings

(ii) Open Protocol

1 point can be scored for using BACnet, Modbus or any other non-proprietary protocol as the network backbone for the building management system (BMS), with the system being able to provide scheduled export of a set of any chosen data points to commonly used file formats.

4.3b Demand Control

Intent

Using occupancy based controls to monitor the usage of common spaces to manage lighting demand and mechanical ventilation equipment, while still maintain lighting and ventilation quality, can significantly reduce building energy consumption. Automated irrigation systems also reduce operation and maintenance requirements, along with better management of limited water resources.

In addition, encouraging the use of car park guidance systems allow motorists to make informed choices to reduce traffic on public roads and reduce search times in car parks, which in turn reduce energy consumption and pollution by the motor vehicles.

Scope

Applicable to all residential buildings.

Assessment

(i) Lighting and Mechanical Ventilation Demand Control

A maximum of 1 point can be scored for the use of the following controls to regulate the operating hours of spaces served by lighting and mechanical ventilation systems:

- Provision of timer sensors / controls for lighting and ventilation systems in community spaces such as link buildings, community halls, etc.
- Provision of Bi-level motion sensors for artificial lighting systems in >80% of the common areas

(ii) Provision of Car Park guidance system

A maximum of 0.5 point can be scored for the provision of a car park guidance system in multi-storey car parks.

4.3c Integration and Analytics

Intent

The innovative and integrative use of sensor and motion data for optimizing or attaining persistence of high performance and energy efficiency in a residential building / development.

Basic integration and use of sensor data can optimise and engage occupants / operators of the building / development in an informed and effective manner. The use of advanced integration and analytics such as energy dashboards or portals, along with data analysis can provide enhanced efficacy in lowering energy use, increase asset reliability, and improve the user experience.

Scope

Applicable to all residential buildings.

Assessment

A maximum of 2 points can be scored for the following:

(i) Basic Integration and Analytics

0.5 point each can be scored for the provision of the following:

- a web portal and/or accessible monthly readout per residential block
- a web portal and/or accessible monthly readout per unit to engage residents

(ii) Advanced Integration and Analytics

1 point can be scored for the provision of a web portal and/or energy dashboard for the development managing operator.

4.3d System Handover and Documentation

Intent

Design and delivery integration is essential to delivering an operationally energy efficient building. The various M&E systems in residential units and throughout the development should be properly tested and verified and to ensure operational continuity from construction to building maintenance and operation. These criteria indicate the presence of a quality assurance plan to maintain the desired energy efficiency and indoor comfort in common spaces, and the specified M&E systems to home occupants' individual units.

Scope

Applicable to all residential buildings.

Assessment

1 point each can be scored for the following:

- Proper system verification and handover of higher-order functional and system level performance of buildings control systems, mechanical systems and electrical systems. The project shall demonstrate a commitment to comply with verification requirements and show evidence of relevant schedules and documentation per residential block
- Proper system verification and handover of applicable mechanical and electrical systems. The project shall demonstrate a commitment to comply with verification requirements and show evidence of relevant schedules and documentation per residential unit

5. Advanced Green Efforts



The Green Mark RB: 2016 Advanced Green Efforts section recognises the implementation of industry leading performance or innovative strategies, designs or processes that demonstrate exceptional levels of sustainability. The 20 points in this section are bonus points that can be added to the base Green Mark score to help projects demonstrate their holistic environmental performance and achieve higher levels of Green Mark award.

The enhanced performance criteria have indicators placed within the 4 main sections of Climatic Responsive Design, Building Energy Performance, Resource Stewardship and Smart and Healthy Building that we have identified as practices that are pioneering initiatives in sustainable design.

The remaining criteria within this section recognise projects that undertake sustainability with the view of market transformation, such as demonstrating cost neutrality. Other criteria recognise broader aspects of sustainability including socio-economic indicators or global sustainability benchmarking that address issues outside of green building rating tools.

Criteria	Points
5.1 Enhanced Performance	15
5.2 Demonstrating Cost Effective Design	2
5.3 Complementary Certifications	1
5.4 Social Benefits	2
TOTAL	20

5.1 Enhanced Performance

Intent

Points can be awarded based on the Advanced Green Efforts indicators that are highlighted within the Green Mark RB: 2016 criteria.

Alternatively, where projects can demonstrate substantial performance to a specific sustainability indicator or outcome addressed within Green Mark will be reviewed on a case by case basis. Points can be awarded based on the relative environmental benefits and improvement as compared to other Green Mark indicators.

Assessment

Cap at 15 points for enhanced performance indicators per project.

Submission requirements for assessment shall follow the guidance for each enhanced performance indicator within the main Green Mark sections.

5.2 Demonstrating Cost Effective Design

Intent

Projects that can demonstrate that they have achieved high levels of environmental performance without an increased capital expenditure are of great interest to promote market transformation and encourage the mass market to drive towards higher levels of environmental sustainability.

Assessment

1 or 2 points respectively can be scored for demonstration of cost effective or cost neutral design beyond the norm through a detailed quantity surveyor's report of the building.

5.3 Complementary Certifications

Intent

Green Mark is an assessment tool that assesses the environmental sustainability of a building. However, the consideration of sustainability indicators beyond those relevant to the built environment is also important.

Assessment

1 point can be scored where the project demonstrates that it is certified through a local or international complementary certification or rating tool that assesses the project beyond the environmental indicators within Green Mark RB: 2016.

5.4 Social Benefits

Intent

While Green Mark focuses on environmental sustainability, this criterion rewards projects that are able to demonstrate that their project contributes to social sustainability.

Assessment

A maximum of 2 points can be scored for projects that demonstrate their social benefits or how social sustainability has been incorporated into the project. This can (but not limited to) include efforts that demonstrate enhanced considerations to wellbeing, community integration efforts and clean energy purchase through leasing contracts.

Annex A: Computational Fluid Dynamics Simulation Methodology and Requirements

A1. General

The CFD simulation methodology requirements encompasses 4 segments: (i) Step 1- Ventilation Simulation Modelling, (ii) Step 2- Ventilation Simulation Modelling, (iii) Step 3- Thermal Comfort Modelling and (iv) Wind driven rain.

The natural ventilation simulation shall be carried out using Computational Fluid Dynamics (CFD) modelling to identify the most effective building design and layout for the development. The simulation results and recommendations derived are to be adopted to meet the intent of the criteria.

A2. Simulation Software

The CFD modelling shall be carried out using well validated software. The CFD solver shall have the minimum capability of solving the Navier-Stokes fluid flow equations for a three-dimensional incompressible flow at steady state. Turbulence modelling shall also be included with the minimum requirement of using the standard k-ε turbulence model, coupled with the standard wall function. *(Note: It is recommended to use the enhanced RANS eddy viscosity model (apart from the minimum realizable k-ε turbulence model) and RANS Reynolds Stress Model.)*

A3. Conditions

All simulation models shall be carried out under isothermal conditions of 29.5°C air temperatures at steady state condition. If the impact of heat sources is significant, heat source modelling shall be included. *(Note: The aggregated heat load from heat dissipating devices shall be modelled. Boussinesq or variable density can be used.)*

A4. Computational Domain and Surrounding Buildings

The computational domain shall include the development of interest and the far field boundary which should be located far enough from the building model to avoid artificial acceleration of the flow. As a general guideline, the direction blockage ratio (BR_L & BR_H) along lateral and vertical directions should be less than 17%.

$$BR_L = \frac{L_{Buildings}}{L_{Domain}} < 17\%$$

$$BR_H = \frac{H_{Buildings,max}}{H_{Domain}} < 17\%$$

It is also important to ensure that the blockage ratio (BR) arising from the projection of building frontal to the domain enclosure is no larger than 3%.

The computational domain shall include the development of interest as well as the explicitly modelled surrounding buildings. The extent of the surrounding buildings to be explicitly modelled shall be within the proximity of minimum 3 times the length of the longest distance measured across the boundary of the development, or within 500 m distance from the edge of development of interest, whichever that is smaller. In the event that the building and surrounding development are located within hilly terrain, the topography information should also be included in the simulation models. The domain height shall be extended, approximately 6 times the height of the tallest building within the defined vicinity.

A5. Grid size

The computational grid generated for all simulations shall resolve the salient flow features in the naturally ventilated spaces and around the development. The recommended grid sizes are as follows:

Location	Grid Size (m)
Within the functional spaces of interest	0.1 – 0.2
Building of interest	0.5 – 1.0
Surrounding building	1.0 – 5.0
From ground surface to 10m height in vertical direction	0.5 – 1.0
From 10m height to H_{\max} height in vertical direction, (H_{\max} is the height of the tallest building among the group of buildings modelled explicitly)	1.0 – 5.0

As a guide, the dimension of the computational elements is advised to follow the principles such as:

- Proper domain decomposition should be carried out to ensure a good quality mesh can be obtained.
- Hexahedra or prism body-fitted grid are preferred.
- A grid independent test shall be performed at the functional space through grid refinements in areas with sharp gradients.
- In terms of the computational cell quality, the skewness of the cell is advised no greater than 0.9.
- The maximum stretching ratio for near building cell size should be kept to be less than 1.4.

A6. Boundary Condition & Turbulence Modelling

(a) Inlet Atmospheric Boundary Condition

Based on local climatic wind conditions, meteorological data on the precise wind direction and velocity of the proposed site location for the months of December, March, June and September shall be used for the CFD simulation. The prevailing wind conditions, such as the mean speed and direction for Singapore, shall be based on NEA's 18-year data at a reference height of 15.0 m as follows:

Wind Direction	Mean Velocity (U_{ref}) (m/s)
North	2.0
North-East	2.9
South	2.8
South-East	3.2

The inbound vertical wind profile shall be assumed to be given by the Logarithmic Law with reference height at 15.0 m.

The wind profile shall be determined by using the following equations:

$$U(z) = \frac{u_{ABL}^*}{\kappa} \ln \left(\frac{z + z_0}{z_0} \right)$$

$$k(z) = \frac{u_{ABL}^{*2}}{\sqrt{C_\mu}}$$

$$\varepsilon(z) = \frac{u_{ABL}^{*3}}{\kappa (z + z_0)}$$

$$u_{ABL}^* = \frac{U_{ref} \kappa}{\ln \left(\frac{h + z_0}{z_0} \right)}$$

Where

u_{ABL}^* : Atmospheric boundary layer (ABL) friction velocity

κ : von Karman constant (0.42)

C_μ : A constant, generally taken equal to 0.09

z_0 : Aerodynamic roughness length

U_{ref} : The specified velocity at reference height h

The aerodynamic roughness length z_0 for wind profile should be selected from the updated Davenport-Wieringa roughness classification as follows, to match the terrain category of the development site of interest.

z_0 (m)	Landscape Description
0.0002 Sea	Open sea or lake (irrespective of the wave size), tidal flat, snow-covered flat plain, featureless desert, tarmac, concrete, with a free fetch of several kilometres
0.005 Smooth	Featureless land surface without any noticeable obstacles and with negligible vegetation; e.g. beaches, pack ice without large ridges, morass, and snow-covered or fallow open country.
0.03 Open	Level country with low vegetation (e.g. grass) and isolated obstacles with separations of at least 50 obstacle heights; e.g. grazing land without windbreaks, heather, moor and tundra, runway area of airports.
0.10 Roughly open	Cultivated area with regular cover of low crops, or moderately open country with occasional obstacles (e.g. low hedges, single rows of trees, isolated farms) at relative horizontal distances of at least 20 obstacle heights.
0.25 Rough	Recently-developed “young” landscape with high crops or crops of varying height, and scattered obstacles (e.g. dense shelterbelts, vineyards) at relative distances of about 15 obstacle heights.
0.50 Very rough	“Old” cultivated landscape with many rather large obstacle groups (large farms, clumps of forest) separated by open spaces of about 10 obstacle heights. Also low large vegetation with small interspaces such as bush land, orchards, young densely-planted forest.
1.0 Closed	Landscape totally and quite regularly covered with similar-size large obstacles, with open spaces comparable to the obstacle heights; e.g. mature regular forests, homogeneous cities or villages.
≥ 2.0 Chaotic	Centres of large towns with mixture of low-rise and high-rise buildings. Also irregular large forests with many clearings.

(b) Ground Surface

Using appropriate roughness parameters is an essential component for accurate simulation of Atmospheric Boundary Layer (ABL) flow. The two types of roughness parameters, (i) aerodynamic roughness length z_0 and (ii) equivalent sand-grain roughness height k_s , should be applied on different surface areas as listed:

Ground Surface Area	Roughness Parameter	
Area 1: From domain Inlet boundary to the boundary of explicitly modelled buildings	Aerodynamic length z_0	roughness
Area 2: Within the region of explicitly modelled buildings	Aerodynamic length z_0	roughness
Area 3: Within the site boundary of the development of interest	Equivalent roughness height k_s	sand-grain

The region of inlet, approach and incident flow at the upstream of computational domain should be modelled with appropriate aerodynamics roughness length z_0 as well as the relationship between equivalent sand-grain roughness height k_s with the corresponding aerodynamics roughness length z_0 .

(c) Top and Lateral Surface of Domain

Use zero velocity gradients and zero normal gradients, i.e. “symmetry” condition, for all variables at the top and lateral surface when the top and lateral boundaries of the domain are far away enough from the buildings (refer to the requirements on the domain size).

(d) Outlet Surface of Domain

Use zero static pressure as the boundary condition at the outlet surface of computational domain.

A7. Discretization Schemes

In all circumstances, the users should attempt to apply 2nd order discretization schemes, which are preferred over 1st order discretization schemes to avoid numerical diffusion.

A8. Convergence Criteria

To ensure the changes in solution variables from one iteration to the next are negligible, residuals with at least 4 orders of magnitudes shall be achieved. In addition, monitoring points should be defined in the region of interest and the velocities at those points should be recorded to ensure that the flow has reached steady values when simulation is converged properly. For unit simulation, surface monitoring should be defined within the applicable areas (refer to A9bii) on definition of applicable areas). Area-weighted average velocities at those surface monitors should be recorded to ensure that the flow has reached steady values when simulation is converged.

A9. Ventilation Simulation Modelling Methodology and Requirements

To be eligible for Green Mark Platinum rating, it is a requirement to use ventilation simulation modelling and analysis or wind tunnel testing to identify the most effective building design and layout. The simulation results and the recommendations derived are to be implemented to ensure good natural ventilation. Projects are given the following pathway to comply with the requirement:

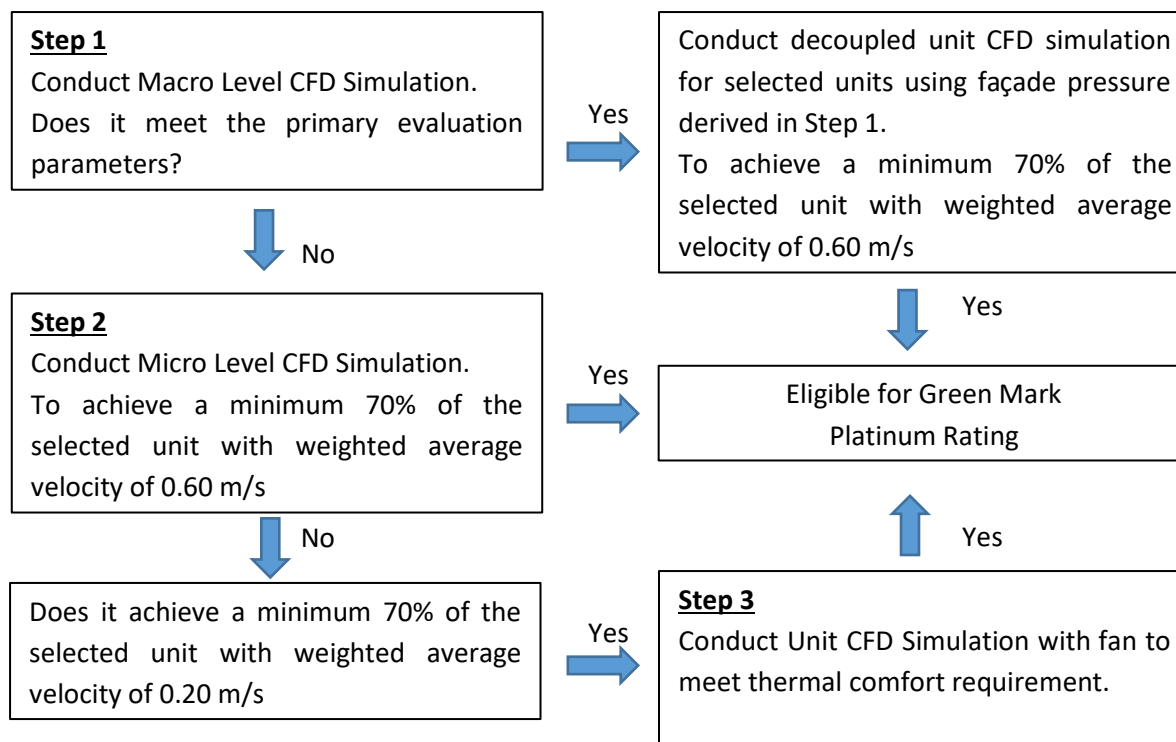

Determine up to five (5) typical unit design layouts that have the majority number of units. If the proposed building development comprises less than 5 typical unit types, all the typical unit design layouts are to be selected for the simulation.

There shall be two iterations of simulation models to assess the wind flow conditions and air-flow pattern within the development to demonstrate the improvement in natural ventilation design. The simulation modelling can be conducted based on the two best prevailing wind directions for the building development that is North or North-East and South or South-East.

(a) Step 1 ventilation simulation modelling for development

- Conduct a large scale ventilation simulation modelling for development using the specified computational domain and grid stated to assess the wind flow conditions around the proposed building development and adjacent buildings. Natural ventilated corridor linked to the unit should be taken into consideration for the simulation models.
- From the simulation results, determine the wind pressure taken at 0.5 m from every assumed opening of all units at mid height level (capped at 20 storey height) and the pressure difference (i.e. the difference of the maximum and minimum wind pressure) of each unit. In instances,

where all or some of the typical unit layouts are not designed at mid-height level, the average wind pressure and respective pressure differences should be determined for these typical units located at the level closest to the mid-height level.

- Calculate the global pressure differential by summing all the pressure difference of all units divided by the total number of units (at mid height level).
- If the development level simulation result meets either one of the following primary evaluation parameters, project can assess under step 1 ventilation simulation modelling for units. If the primary evaluation parameters cannot be met, step 2 ventilation simulation modelling for units should be performed
 - A minimum 60% of Dwelling Units with window openings facing the prevailing north or north-east and south or south-east directions AND a minimum 2.7 Pa of Global Pressure Differential of Dwelling Units located at building mid height level

OR

- If < 60% of Dwelling Units with window openings facing the prevailing north or north-east and south or south-east directions, to meet a minimum 4.3 Pa of Global Pressure Differential of Dwelling Units located at building mid height level.

(b) Step 1 ventilation simulation modelling for units

- Once the primary evaluation parameters is met, conduct unit simulation to assess the air-flow patterns within all the five selected typical dwelling unit types. The façade wind pressure result taken from A9(a) shall be prescribed as the boundary condition. All living spaces in the dwelling unit are to be included in the modelling except for enclosed space, such as storeroom or CD shelter. All windows & doors are assumed to be fully opened as designed except for the main door which is assumed to be closed at all time.
- For residential buildings, the applicable areas refer to living room, open kitchen (which is connected to the living room), study rooms and all bedrooms. The area weighted average wind velocities of these areas are to be computed at horizontal plane 1.2 m above the floor level.
- The selected unit is deemed to have good natural ventilation if the area-weighted average wind velocity of the unit is not less than 0.6 m/s. The overall percentage of units achieving good natural ventilation is given by:

$$\frac{\sum (\text{No. of Selected Units for Each Layout} \times \text{Area-Weighted Average Wind Velocity}) \times 100\%}{\text{Total Number of Selected Units} \times 0.6\text{m/s}}$$

(c) Step 2 ventilation simulation modelling for units

- If the primary evaluation parameters cannot be met, from results of step 1 ventilation simulation for development, select the unit with pressure difference that is closest to the average pressure difference from each typical unit design layout. The maximum allowable margin of $\pm 10\%$ difference from the average pressure difference is deemed acceptable.
- Conduct a large scale CFD simulation to assess the air flow conditions of these five (5) selected units. All living or functional spaces in the unit are to be included in the simulation modelling except for enclosed spaces such as storeroom or CD shelter. All windows & doors are assumed

to be fully opened as designed except for the main door which is assumed to be closed at all time.

- From the simulation results, determine the area-weighted average wind velocity of each selected unit by considering the air flow conditions of the applicable areas. For residential buildings, the applicable areas refer to living room, open kitchen (which is connected to the living room), study rooms and all bedrooms. The area weighted average wind velocities of these areas are to be computed at horizontal plane 1.2 m above the floor level. The same applies to naturally ventilated functional spaces for non-residential buildings.
- The selected unit is deemed to have good natural ventilation if the area-weighted average wind velocity of the unit is not less than 0.6 m/s. The overall percentage of units achieving good natural ventilation is given by:

$$\frac{\sum (\text{No. of Selected Units for Each Layout} \times \text{Area-Weighted Average Wind Velocity}) \times 100\%}{\text{Total Number of Selected Units} \times 0.6\text{m/s}}$$

(d) Step 3 thermal comfort modelling for units

For development unable to satisfy the minimum velocity prerequisites for Green Mark Platinum rating but a minimum 70% of selected typical dwelling units with “moderate” natural ventilation (with minimum weighted average wind velocity of 0.2m/s), mechanically assisted ventilation shall be provided and thermal comfort modelling could be performed.

The thermal comfort assessment, where required, shall be carried out using Predicted Mean Vote (PMV) equation to identify the most effective building design and layout for the development. The assessment and simulation results and recommendations derived are to be adopted to meet the intent of the criteria.

Thermal comfort modelling shall be performed based on the following PMV equation and comply with the stated PMV range.

$$\text{PMV} = -11.7853 + 0.4232\text{DBT} - 0.57889\text{WIND}$$

PMV Range	PPD
-0.5 < PMV < +0.5*	<10*

where DBT is indoor air temperature (°C). Baseline of T is 29.5°C

WIND is indoor wind speed (m/s). The value shall be derived from the result of indoor ventilation simulation via the Ventilation Simulation Methodology and Requirements in this annex. Natural ventilation simulation with fan modelling can be performed based on selected dwelling units alone, without the inclusion of external domain with prevailing wind flow condition.

PMV is Predicted Mean Vote

PPD is Predicted Percentage Dissatisfied

A10. Wind Driven Rain Methodology and Requirements

If the project is targeting to score for Wind driven rain (WDR) simulation under Advanced Green Efforts, WDR shall be carried out to identify and to reduce the severity of rain penetration into naturally-ventilated areas. Four different raindrop sizes are to be analyzed. From the simulation results, the depth of rain penetration (measured from the fenestration opening) into the functional spaces of the development shall be determined, and the most effective mitigation method to reduce the severity of rain penetration without manual behavioural intervention identified. The simulation results and recommendations derived are to be adopted to meet the intent of the criteria if points are to be scored.

The severity of rain penetration are as follows:

	Depth of rain penetration
1. Very good (no noticeable penetration of WDR)	Depth of rain penetration ≤ 0.20 m
2. Good (some but acceptable degree of penetration of WDR)	Depth of rain penetration ≤ 0.40 m

The frequency of WDR occurrence are as follows:

	Return Period
1. Type 1 Rain (no WDR risk)	Return Period ≤ 2 months
2. Type 2 Rain (low WDR risk)	Return Period ≤ 6 months

The methodology will use the CFD methodology outlined within the section on *Ventilation Simulation Methodology and Requirements* and adapt it to the following requirements as highlighted below:

(i) Software

The software shall be also be capable of second-order discretization schemes with Lagrangian particle tracking.

(ii) Boundary Condition & Turbulence Modelling

(a) Inlet Atmospheric Boundary Condition

The inbound vertical wind profile shall be assumed to be given by the Logarithmic Law with reference height at 15.0 m. The prevailing wind condition during raining period such as the wind velocity magnitude of different return periods for Singapore shall be based on NEA 32-year data at a reference height of 15.0 m as follows:

Wind Direction [deg]	NORTH 000°	NORTH-EAST 045°	EAST 090°	SOUTH-EAST 135°	SOUTH 180°	SOUTH-WEST 225°	WEST 270°	NORTH-WEST 315°
Return Period (months)	Wind Velocity (m/s)							
1	2.9	3.8	4.4	4.5	4.4	3.5	3.4	3.0
2	3.9	4.9	5.0	5.2	5.2	4.4	4.1	3.6
3	4.8	5.8	5.5	5.9	5.8	5.2	4.8	4.1
4	5.4	6.3	5.9	6.3	6.3	5.7	5.2	4.4
6	6.2	7.1	6.3	6.8	6.8	6.3	5.7	4.8
9	7.0	7.8	6.7	7.3	7.4	7.0	6.3	5.2
12	7.5	8.4	7.0	7.7	7.8	7.4	6.6	5.5

(b) Rain Drop Size

Four different raindrop sizes shall be analysed, and the respective terminal velocity (V_{terminal}) of different raindrop sizes are as follows:

Raindrop [mm]	Diameter	V_{terminal} (m/s)
0.5		-2.0
1.0		-4.0
2.0		-6.5
5.0		-9.0

(c) Drag Coefficients

The drag coefficients for the raindrops (C_d) is a function of the relative Reynolds number (Re) and shall be taken from the table as follows:

Re (-)	C_d (-)
1.80	15.0

9.61	4.20
23.4	2.40
43.2	1.66
68.7	1.28
98.9	1.07
134.0	0.926
175.0	0.815
220.0	0.729
269.0	0.671
372.0	0.607
483.0	0.570
603.0	0.545
731.0	0.528
866.0	0.517
1,013.0	0.504
1,164.0	0.495
1,313.0	0.494
1,461.0	0.498
1,613.0	0.503
1,764.0	0.511
1,915.0	0.520
2,066.0	0.529
2,211.0	0.544
2,357.0	0.559
2,500.0	0.575
2,636.0	0.594
2,772.0	0.615
2,905.0	0.635
3,033.0	0.660

3,164.0	0.681
3,293.0	0.700
3,423.0	0.727
3,549.0	0.751

(d) Other Settings

Piecewise integration of raindrop equation of motion performed under Lagrangian Particle Tracking shall not be larger than 0.05 m length step size.

The injection location of raindrops shall be located inside the computational domain and outside the zone that is influenced by the buildings. The raindrops shall be released high enough to enable them to reach their terminal velocity of fall. It is recommended to use the following general rules to select the raindrop injection planes inside the computational domain:

- The width and length of the plane should be larger than that of the building of interest
- The vertical location of the plane depends on the velocities and raindrop diameters:
 - Higher velocities require a lower vertical location
 - Larger raindrops require a higher vertical location
- The horizontal location depends on the chosen height of the injection plane, the raindrop diameter and the reference wind velocity chosen for the simulation (recommended to be located at least 15H from the target building)

A11.Guidance Notes

The following are guidance notes to help project teams keep track of their natural ventilation design and simulation progress.

Guidelines	Description/Selection	Response & Criteria
Submission Details		Provide the project details (especially information on natural ventilated design, building massing/orientation, GFA of natural ventilated spaces, % of opening & windows, credible source of site information with surrounding buildings, vegetation and terrain, future development etc.)
Problem Statement	Objective & Work Scope	Describe natural ventilated challenges, proposed solution, desired outcome and work scopes from the simulation model. Whenever necessary, use the architectural drawing for explanation. Describe design

		stages and fix simulation details. Subsequent design change has to be supported by simulation results.
Site Information	Minimum 3 times the length of the longest distance measured across the boundary of the development, or within 500 m distance from the edge of development of interest, whichever that is smaller	Describe the site information (including surrounding buildings, terrain, greenery), and illustrate how the geometrical info is incorporated into the simulation model (conversion process). Surrounding buildings within 500m distance stream wise and span wise from the edge of development of interest should be modelled explicitly; while the greenery can be modelled implicitly with tree canopy approach. Terrain effect can be ignored if elevation is less than 10m.
CFD Approach	Simulation Methodology	The CFD solver shall have the minimum capability of solving the Navier-Stokes fluid flow equations for a three-dimensional incompressible flow at steady state. Turbulence modelling shall also be included with the minimum requirement of using the standard k- ϵ turbulence model, coupled with standard wall function
	Assumption & Simplification	Describe simulation model assumption, limitations and geometrical simplification. Whenever necessary, use the published literature data (including software manual) and comparison between architectural & CFD model for explanation
CFD Domain	Computational Domain	Describe the domain decomposition methodology; and relevant meshing type for each domain within the site. Describe the domain that be modelled implicitly with Davenport Roughness classification
CFD Meshing	Mesh size, distribution and quality	To carry out proper domain decomposition. To use hexahedral cells in the rectangular domain of NV space. Tetrahedral cells can be used to model the surrounding site features of the NV space. Hybrid pyramid or cut-cell mesh can be adopted at the interface. For implicit modelling of terrain roughness effect, prismatic or hexahedral cells is recommended to be used. As a guide, the dimension of the computational mesh should be set at 0.1 to 0.2 m within the functional space of interest, 0.5 to 1.0 m for building of interest and 1.0 - 5.0 m for surrounding buildings. The computational element size in vertical direction should be set at 0.5 - 1 m from ground surface to 10m height; followed by 1 -

		5m to Hmax height. Reporting on skewness and aspect ratio of the mesh is required.
CFD Model	Atmospheric Boundary Layer	<ol style="list-style-type: none"> 1. To ensure horizontal ABL homogeneity in upstream and downstream 2. To ensure sufficiently high mesh resolution in vertical direction near ground (e.g. height of first cell < 1m) 3. To know the relationship between equivalent sand-grain roughness height (k_s) and corresponding aerodynamic roughness height, z_o 4. To ensure first cell center point (y_p) to be larger than physical roughness height (k_s)
	Buoyancy	To use Boussinesq or variable density and check gravity direction, if thermal simulation is performed.
	Turbulence model	To use the steady Reynolds-Average Navier Stokes (RANS), with minimum requirement k- ϵ turbulence model equation for NV flow.
CFD Boundary Conditions	Inlet wind profile	To ensure the vertical profile for wind velocity and turbulence in the ABL should be modelled by assuming constant shear stress with height.
	Top & lateral sides of domain	To use zero velocity gradients and zero normal gradients of all variables.
	Outlet plane	To use zero static pressure.
	Window modelling	To use actual window opening size. Attach window schedule and drawing for verification.
	Mechanical fan modelling	To use fan input with appropriate swirl radial and swirl flow components.
	Louver modelling	To use simplified porous zone with appropriate pressure drop components and directional effect.
	Heat source modelling	To use aggregated heat load from heat dissipating devices, such as cooking stalls for hawker center facilities, heat generators for industrial facilities and etc.
CFD Numerical	Discretization scheme	To use 2 nd order for momentum equations
	Convergence criteria	To ensure solution is converged and monitored points at functional space reach steady values

User		Training, experience, consult expert
Documentation		Full documentation of parameters, readable scale
Design Iteration	Baseline case Modified case Optimal case	Baseline case – fixed building massing and layout Modified case – to highlight improvement on NV design Optimal case – final design with incorporation of NV features or passive innovative ideas

A12.Documentation Requirements

Design Stage

The Qualified Person (QP) and the other appropriate practitioners shall ensure that the following report and building 3D model are available as evidences to demonstrate compliance with the ventilation simulation framework. The report should comprise the following items:

2.0 Cover page with a proper title, design image of development, developer's information (including developer's name and address and person-in-charge), consultant's detail (including the principal's name and authorized signature, firm's address and person-in-charge)

3.0 Table of Contents

4.0 Executive Summary

- Background of the development
- Main findings
- Concluding remarks

5.0 Background/ Introduction

- Building and site information
- Design strategies
- Detail of natural ventilation spaces (location, area, window to wall ratio etc.)

6.0 Methodology

- Describe methodology used in the study

7.0 Geometrical Model

- Isometric view of the development from various angles
- Domain size used
- Plan and 3D isometric model of units from various angles

8.0 Simulation settings

- Boundary conditions
- CFD software/ models used/ numerical scheme
- Mesh / cell sizing
- Solution control-convergence criteria

9.0 Result and Discussions

- Simulation results for the development for all directions showing the main graphical plots of the plan pressure and velocity vector and salient findings
- Tabulation showing the listing and details of all simulated NV spaces and the area-weighted average wind velocity within each simulated space where applicable

10.0 Conclusion

11.0 Appendix: The following plots are to be placed in the appendices:

- Simulation results for the development for each direction
 - Static pressure (plan view-ground & mid elevation and at the level of simulated NV space, isometric views on building façade)
 - Velocity vector and contour showing the plan view at ground & mid elevation and at the level of simulated NV space, and a few isometric sectional cut plans to show air-flow patterns across the development
- Simulation results for the natural ventilated spaces for each direction
 - Static pressure (plan view at the level of simulated NV space)
 - Velocity vector and contour showing the plan view at the level of simulated NV space, and a few isometric sectional cut plans to show air-flow patterns across the NV space

If thermal comfort modelling or air quality assessment is attempted, a corresponding chapter in the report shall be added to show the relevant calculations.

If WDR simulation is carried out, a chapter in the report shall be added to show the results of Wind Driven Rain penetration under different wind directions and the calculation of green mark points for WDR performance. The report also shall contain the following information:

- Injection location of the raindrop into the computational domain (plan and sectional views)
- Raindrop trajectory into functional spaces (plan and sectional views)
- Tabulation showing the listing and details as well as the corresponding depth of rain penetration of all occupied spaces where applicable.

Verification Stage

- The project team shall declare if any changes had been made in actual built layout compared to the submitted 3D ventilation simulation model in the design stage. The re-assessment of ventilation simulation will depend on the extent of changes and their impacts on NV performance.
- If thermal comfort modelling assessment is attempted, the percentage of opt-out decisions of home buyers should be table.

Annex B: Guidelines on Pre-Simulated Daylight Availability Tables and Daylighting Simulation Methodology

B1. General

Buildings attempting to meet the daylighting credit can achieve the criteria based on the Simplified Pre-computed Method for Standard Designs or through Detailed Daylighting Simulations, both outlined in this appendix. Buildings with simple façade designs and typical room heights (2.5 to 3.1m) that can be described by their orientation, window-to-wall ratio (WWR), glazing visible light transmittance (T_{vis}) and simple horizontal overhang shading devices are candidates for achieving the credit using the Pre-computed Method for Standard Designs. Buildings that employ unusual forms, advanced daylight redirection systems, complex facades, top-lighting strategies, double-height spaces or other specialized design strategies should employ a full Detailed Daylighting Simulation.

Daylighting Metric Definitions

The following two lighting measures, Daylight Autonomy and Useful Daylight Illuminance Exceeded, are used to relate the lighting quality of a design through a simulation-based analysis of an entire building or specific space.

Daylight Autonomy ($DA_{N\text{ lx}}$)

Daylight Autonomy (DA) is a metric which describes the annual sufficiency of natural lighting levels in an indoor space relative to a desired illuminance level. It is defined as the percent of time a minimum illuminance level can be achieved from daylight alone during the occupied hours of the building. The minimum lighting level of 200lux is given by CP38 for residential buildings. A portion of a space is considered daylit when it has a $DA_{N\text{ lx}}$ value greater than or equal to 50 % of the building's occupied hours, where N is the desired illuminance level. The percentage of floor area meeting this requirement for residential buildings is therefore denoted as $DA_{200\text{ lx}, 50\%}$.

Useful Daylight Illuminance Exceeded ($UDI_{e3000\text{ lx}}$)

Useful Daylight Illuminance Exceeded (UDI_e) is a metric which describes the annual percentage of overlighting and increased potential for visual discomfort in a space. It is defined as the percent of time an illuminance level greater than 3000 lx is achieved during the occupied hours of the building. A portion of space is considered to have exceeded acceptable thresholds when its $UDI_{e3000\text{ lx}}$ value is greater than or equal to 10 % of occupied hours. The percentage of floor area exceeding acceptable lighting levels can be abbreviated as $UDI_{e3000\text{ lx}, 10\%}$. Note that $UDI_{e3000\text{ lx}}$ is equivalent to $DA_{3000\text{ lx}}$, and the two are interchangeable.

Daylit and Overlit Areas

Daylit area indicates a percentage of floor area that is well-daylit but not overlit. It is explicitly defined as the percentage of floor area meeting $DA_{N\text{ lx}, 50\%}$, meeting the minimum lighting value more often or equal to 50% of occupied hours. Overlit areas are defined as those with an $UDI_{e3000\text{ lx}, 10\%}$ level, exceeding 3000 lx more frequently than 10% of occupied hours. Designs with an $UDI_{e3000\text{ lx}, 10\%}$ level covering 15% or more of the floor area or with greater than 1.3 m depth of penetration measured from the façade are considered overlit.

Requirements

Residential buildings should calculate $DA_{200\text{ lx}}$ and $UDI_{e3000\text{ lx}}$ using an occupancy schedule from 7:00 AM to 10:00 AM and from 4:00 PM to 7:00 PM. Overlit areas meeting $UDI_{e3000\text{ lx}, 10\%}$ must not be counted as daylit and must be subtracted from the $DA_{200\text{ lx}, 50\%}$ daylit area.

B2.Pre-Simulated Tables and Methodology for Standard Designs

This section outlines how to use the pre-simulated daylight autonomy tables to meet the simplified pre-computed method for standard designs. The pre-simulated daylight autonomy tables were derived from more than 4,000 simulated results using a reference shoebox model. The tables can be used as a simplified method to determine the comfortable daylighting for each space. They are suitable for use for spaces with standard designs in of the occupancy type listed. The tables may be found at the following link:

https://www.bca.gov.sg/GreenMark/others/GMRB2016_Daylight_Availability_Tables.pdf

Spaces with standard designs are defined by the following building characteristics and urban parameters:

- a) Spaces with simple façade designs that can be described by orientation, window-to-wall ratio (WWR), and glazing visible transmittance (T_{vis})
- b) Spaces with typical room floor-to-ceiling heights between 2.5 m and 3.1 m
- c) Spaces with simple overhang shading devices or no shading devices
- d) Relatively unobstructed spaces with average urban obstruction angles less than or equal to 57.25°

Building and Urban Parameters which Describe 'Standard Designs'

The pre-simulated daylight autonomy tables are based on parametric simulation models depending on several variables. To relate the lighting quantity and quality of a room with a daylight-facing façade, these parameters must be identified for each floor level, orientation and façade design of a building. The floor-to-ceiling height of all rooms described in this section are between 2.5 m to 3.1 m. For daylit spaces of unusual heights, a detailed daylighting simulation should be performed instead of using the tables herein.

Orientation

The orientation parameter is defined as one of the following major directions in plan a façade is oriented towards:

- north— 0°
- northeast— 45°
- east— 90°
- southeast— 135°
- south— 180°
- southwest— 225°
- west— 270°
- northwest— 315°

The design façade orientation chosen should fall within 11.25° of the orientation chosen from the tables.

Window-to-wall Ratio (WWR)

Window-to-wall ratio (WWR) is the percentage of glazing, not including framing and mullions, relative to the entire vertical area of a building or a section of a building facade. For example, a fully glazed building has a WWR less than 100% as mullions and spandrels take up some area.

$$WWR = \frac{\sum \text{Area of Glazing Panes}}{\text{Total Vertical Area}} \times 100$$

There are 10 WWRs included in the pre-simulated daylight autonomy tables: 10%, 20%, 26%, 32%, 39%, 43%, 52%, 60%, 70%, and 87%. The closest WWR value to the actual façade WWR from this list should be chosen for utilizing the pre-simulated daylight autonomy tables.

Visible Light Transmittance (T_{vis})

Visible light transmittance (T_{vis}) is the percentage of visible light that passes through a glazing surface such as a window at normal incidence. A higher value of T_{vis} represents greater visible light transmittance. Six T_{vis} values are represented in the pre-simulated daylight autonomy tables: 25%, 35%, 45%, 55%, 65%, and 75%. A project's T_{vis} should be derived from window material specifications for the project, and the closest value contained in the daylight autonomy tables should be identified.

Overhang Obstruction Angle (OOA)

The overhang obstruction angle (OOA) is a number in degrees describing the portion of sky blocked by a horizontal overhang measured from the bottom of the window assembly. The angle describes the portion of sky from the zenith (directly overhead) to the outside edge of the shading device. Three OOAs are included in the daylight autonomy tables: 0 degrees, 15 degrees, and 30 degrees, and the closest value to the actual project OOA value should be used.

$$OOA = \arctan\left(\frac{H_w}{P}\right)$$

H_w is the height of the windows of the space, and P is the length of the shading device projection.

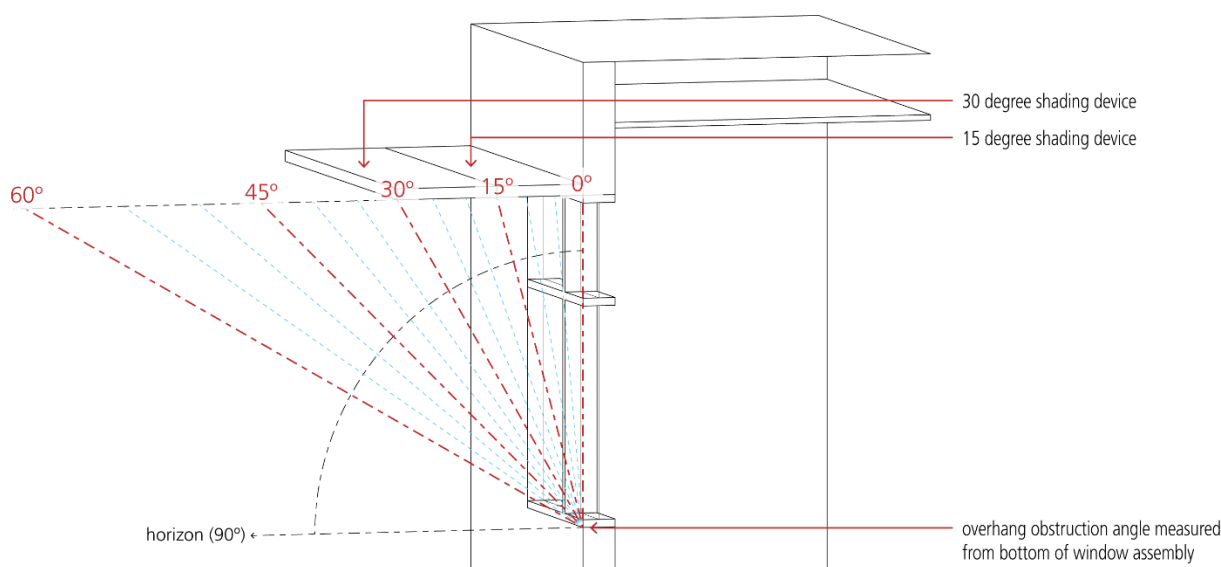

Diagram showing the measurement of the overhang obstruction angle from the bottom window sill

Average Urban Obstruction Angle (AUOA)

The average urban obstruction angle describes the portion of sky blocked by the surrounding urban buildings as measured from the finished floor height of each level and façade of a building. The angle describes the average portion of sky blocked between the horizon and the buildings opposite a façade. It can be determined from the average urban obstruction height in meters, the height of the building floor level above ground, and the distance between neighbouring buildings. Empty lots are not included when calculating the urban obstruction angle.

$$AUOA = \arctan\left(\frac{H - h}{W}\right)$$

Where:

H: Average urban height of the surrounding obstructions measured in meters from the ground.

h: The height of the respective space's floor level above ground.

W: Width of street, between the building and its surrounding obstructions.

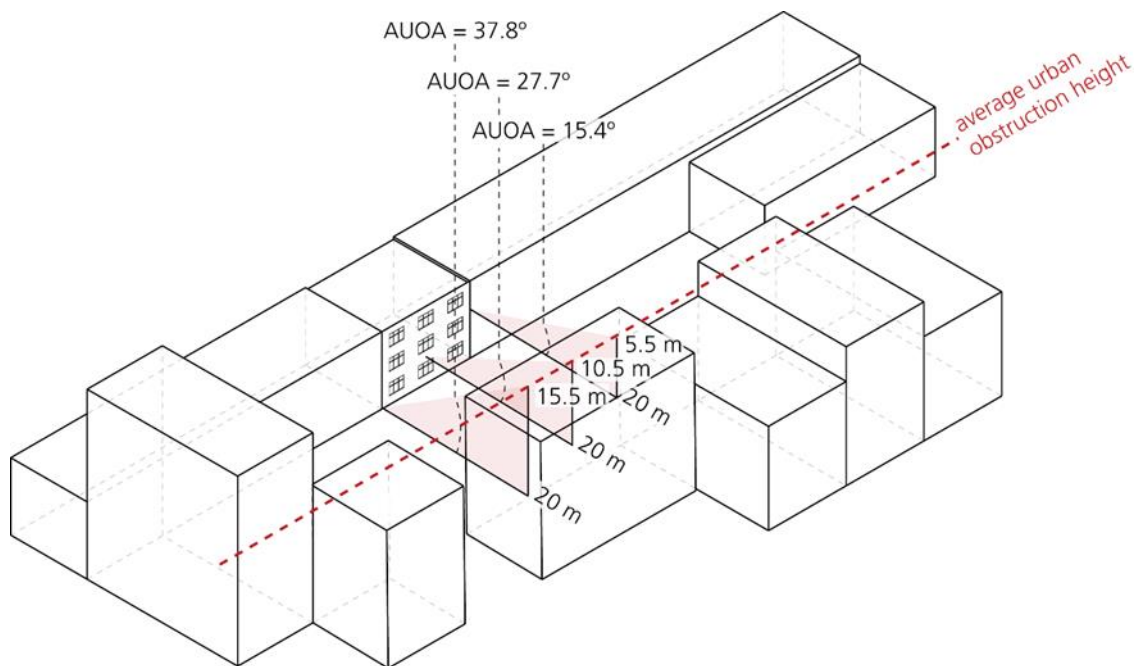

Pre-computed daylight autonomy tables are available for each illuminance threshold for three ranges of AUOAs: 0–11.25 degrees, 11.25–33.75 degrees, 33.75–57.25 degrees. Spaces with an AUOA of greater than 57.25 degrees should employ a detailed daylighting simulation.

Pre-Simulated Tables and Methodology for Standard Designs

The tables relate the building and urban parameters discussed preceding to this section to the depth of the 'daylit area' and potential for glare. Daylit area is defined in the beginning of this document as the room depth measured from the façade achieving the stated lighting requirement for 50% of the occupied period throughout the year ($DA_{N\text{ lx}, 50\%}$). The tables also indicate design combinations that are likely to result in visual discomfort, defined as areas which receive a lighting level of at least 3000 lx for 10% ($UDI_{e3000\text{ lx}, 10\%}$) of the occupied period throughout the year. $UDI_{e3000\text{ lx}, 10\%}$ penetration of more than 1.3 m from the façade indicates a Potential Overlighting and more than 2.0 m from the façade indicates a Risk of Overlighting.

The daylighting metrics portrayed in the tables in this section represent the Green Mark criteria for hotels and residential-style spaces—200 lx during the hours from 7:00 AM to 10:00 AM and 4:00 PM to 7:00 PM.

There are three associated pre-computed daylight autonomy tables with these requirements. The first table is for relatively unobstructed urban contexts with an AUOA between 0 and 11.25 degrees. The second table is for moderately obstructed urban contexts with an AUOA between 11.25 degrees and 33.75 degrees. The final table is for significantly obstructed urban contexts with an AUOA between 33.75 degrees and 57.25 degrees. Spaces with obstruction angles above 57.25 degrees are not likely to be daylit and are not covered by the pre-computed tables. Buildings in such highly obstructed urban contexts wishing to pursue the daylighting credit should perform a detailed daylighting simulation.

Within each table, results are grouped by the OOA (horizontal grouping) and by the building orientation (vertical grouping). Within each grouping, results are ordered by WWR (horizontal axis) and by T_{vis} (vertical axis). The text in each box indicates the depth of the daylit area for that AUOA, OOA, building orientation, WWR and glazing T_{vis} . Combinations which have a $UDI_{3000\text{ lx}, 10\%}$ value exceeding 1.3m depth of penetration into the space are coloured red to indicate Potential Overlighting. Combinations with a $UDI_{3000\text{ lx}, 10\%}$ exceeding 2.0m of penetration into the space are coloured pink to indicate Risk of Overlighting. Spaces with either a high or extreme risk of glare will be deemed not complying to the daylight requirement, and such areas are not to be included as daylit in the simplified pre-computed method for standard designs.

Design combinations which are coloured a shade of blue, indicating the depth of the daylit area and a low likelihood of glare, can be applied directly to qualifications for the daylighting credit without using detailed lighting simulations. The figure below is a graphical representation of the OOA and the WWR design parameters. As previously noted, if a Potential Overlighting and Risk of Overlighting is displayed, the design combination is not eligible to be considered as daylit.

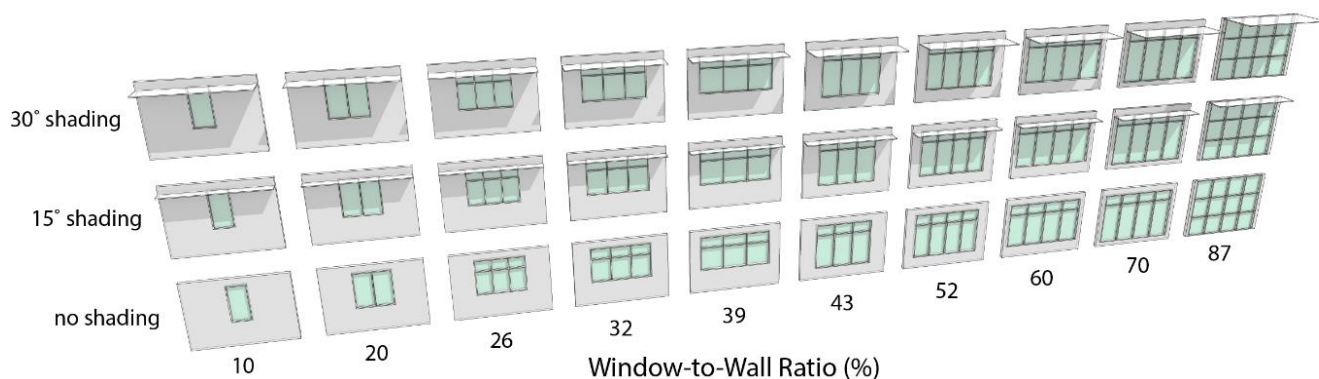

Façade geometric parameters of WWR (horizontal axis) and OOA (vertical axis)

Guidance and Limitations Regarding the Pre-Simulated Daylight Autonomy Tables

There are several limitations to the pre-simulated daylight autonomy tables that should be considered when using them. This postscript describes some of the considerations to take when using them on a Green Mark project.

- Underestimation of lighting in spaces with more than one glazed façade: The pre-simulated daylight autonomy tables document the daylit area for single-sided lit spaces; however, in spaces with windows on two opposing facades, the depth of daylight penetration would naturally increase due to contributions from opposing sides of the space. Such cases may wish to consider using a full simulation to increase their daylit area.
- Potential for double counting: Following directly from the above case, if two glazed facades are located about a single corner, the daylit areas will overlap. The total daylit area in these cases should be calculated using a floor plan drawing in order to avoid double-counting daylight

Worked Example for Residential Building

This process is illustrated by way of an exemplar daylighting analysis carried out in three representative housing units (at the bottom floor, middle floor, and top floor) of an estate building with a large neighbouring building on the North side but open on the South side as depicted below.

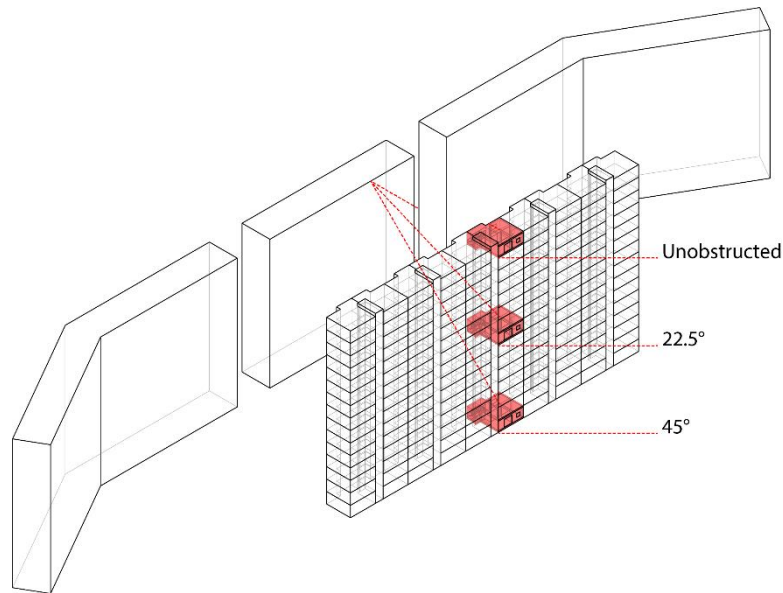

Three units selected for analysis in a 15-storey housing complex. The 1st floor unit has 45° of the horizon obstructed, the 8th storey unit has 22.5° of the horizon obstructed, and the 15th storey unit is unobstructed by the neighbouring buildings.



The typical unit being assessed has 3 rooms for analysis: 2 bedrooms and 1 living room.

First, it is necessary to identify the following parameters about each unit and room:

- (A) Average Urban Obstruction Angle (**AUOA**)—the angle between the finished floor and the top of the average height of adjacent buildings
- (B) Window-to-wall Ratio (**WWR**)—the area of windows divided by the total façade area of each room's façade in the residential unit being studied
- (C) Overhang Obstruction Angle (**OOA**, if any)—the angle between the bottom of the window glass and the outermost edge of a horizontal shading device

- (D) Visible Light Transmittance (T_{vis}) of the window—the percentage of direct normal visible light transmittance through a piece of glazing
- (E) Orientation (**OR**) of the window-walls.

For the units on the North side of the building, the AUOA's are 45°, 22.5°, and 0° for the 1st, 8th, and 15th storey units respectively as illustrated in the above figure. On the south side of the building, the apartments are unobstructed (0° AUOA). WWR is calculated by dividing the glazing area by the total façade area (floor-to-floor including spandrels and floor slabs) for each room. Finally, the T_{vis} value simply comes from product literature, and is 45% in this case. All of this data is recorded in the tables on the following page and should be documented when using the precomputed method.

Note: While kitchens are not included in this analysis portion of GM-2016, the overhang obstruction angle would be the angle formed by a line between the balcony/yard overhang and the bottom of the kitchen's window sill—basically the degree of sky obstructed by the overhanging yard.

Room-specific Parameters of the Typical Unit Being Analysed							
Room	Orientation	WWR (%)	Orientation	OOA (deg.)	Tvis (%)	Area of Room (m²)	Width of Room (m)
Living	South	33.7	South	0	45	15.9	4.1
Master Bedroom	North	15.29	North	0	45	13.3	4.2
Bedroom	South	9.9	South	0	45	11.4	3.2

Following the derivation of the unit parameters being recorded in the table, the depth of comfortable daylight area values must be looked up from the three different AUOA daylight autonomy tables for the various extents of urban obstructions as illustrated on the following page for the living and bedroom using the unobstructed urban context table. The master bedroom needs 3 comfortable depth of daylight values to be recorded: for unobstructed, 22.5 degree and 45-degree urban obstruction angles.

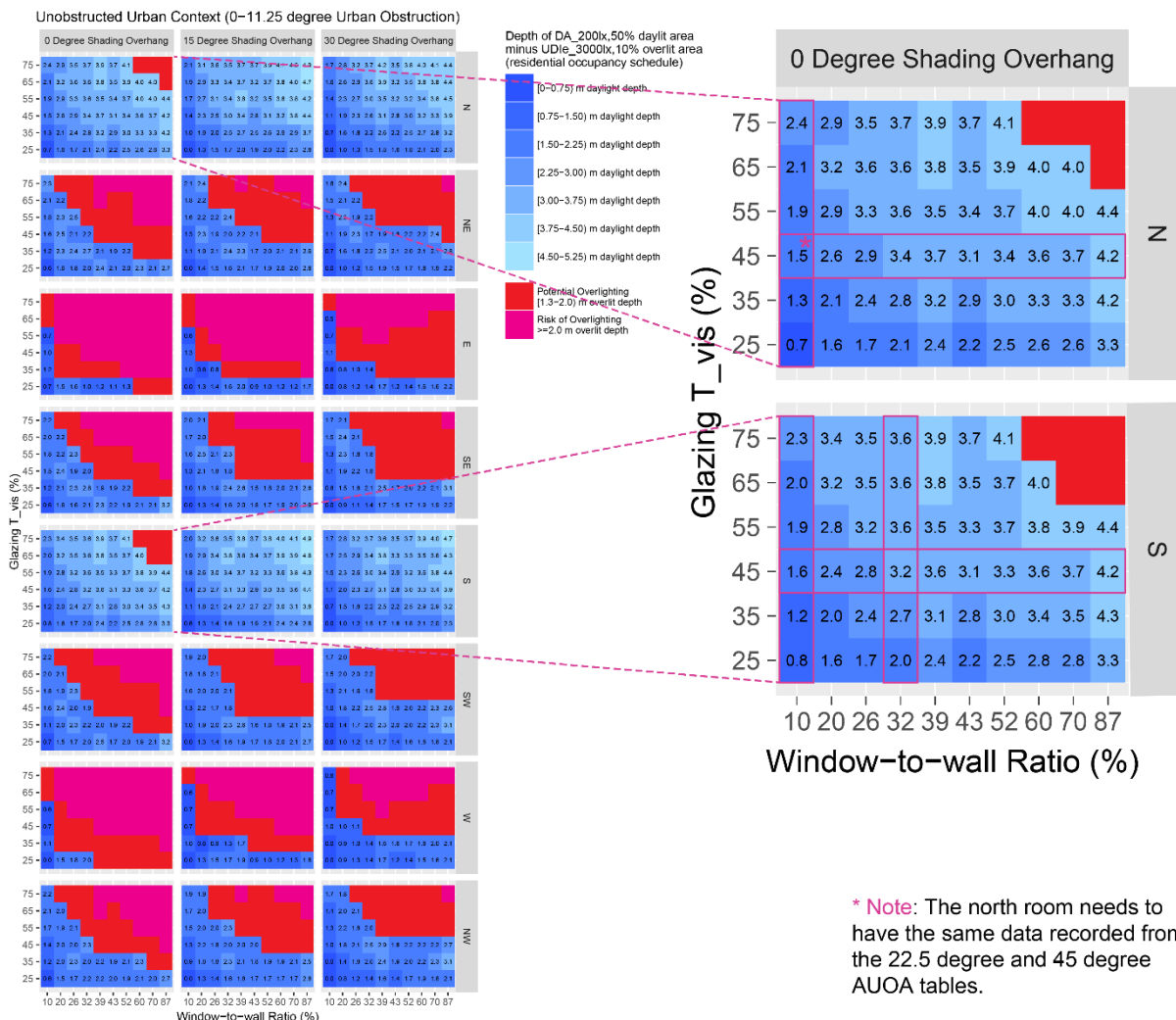

A graphical example selecting the depth of comfortable daylight penetration for the 3 rooms on the 15th, unobstructed floor.

The values in the following table are obtained from the daylight autonomy tables and should be reported in your Green Mark submission. Note that they will not match the simulated data for several reasons: the overlit area is subtracted, and windows are not evenly distributed across the walls of the residential unit.

Room	AUOA: Unobstructed		AUOA: 22.5 degrees		AUOA: 45 degrees	
	Overlit? (Y/N)	Comfortable Daylit Penetration (m)	Overlit? (Y/N)	Comfortable Daylit Penetration (m)	Overlit? (Y/N)	Comfortable Daylit Penetration (m)
Living	N	3.2	--	--	--	--
Master Bedroom	N	1.5	N	1.4	N	0.7
Bedroom	N	1.6	--	--	--	--

Finally, to calculate the total daylit area for each apartment, the depth of comfortable daylit area needs to be multiplied by the room width and divided by the total apartment area.

$$\text{Total Daylit Area} = \frac{\text{DaylitArea}_{\text{Room1}} + \text{DaylitArea}_{\text{Room2}} + \dots + \text{DaylitArea}_{\text{RoomN}}}{\sum \text{AllFloorAreas}}$$

Therefore, the daylit area of the units is calculated as below,

$$\text{1st Storey DA} = \frac{(3.2 \text{ m} \cdot 4.1 \text{ m}) + (1.6 \text{ m} \cdot 3.2 \text{ m}) + (0.7 \text{ m} \cdot 4.2 \text{ m})}{40.6 \text{ m}^2} = \frac{21.2 \text{ m}^2}{40.6 \text{ m}^2} = 52.2\%$$

$$\text{8th Storey DA} = \frac{(3.2 \text{ m} \cdot 4.1 \text{ m}) + (1.6 \text{ m} \cdot 3.2 \text{ m}) + (1.4 \text{ m} \cdot 4.2 \text{ m})}{40.6 \text{ m}^2} = \frac{24.1 \text{ m}^2}{40.6 \text{ m}^2} = 59.3\%$$

$$\text{15th Storey DA} = \frac{(3.2 \text{ m} \cdot 4.1 \text{ m}) + (1.6 \text{ m} \cdot 3.2 \text{ m}) + (1.5 \text{ m} \cdot 4.2 \text{ m})}{40.6 \text{ m}^2} = \frac{24.5 \text{ m}^2}{40.6 \text{ m}^2} = 60.4\%$$

The number of units which meet thresholds of $\geq 60\%$ and $\geq 75\%$ daylit area must be tallied and used to assess the GM points awarded for this design. There are 3 unit types based on the different urban exposures vertically along the building (floors, 1, 8 and 15), and only the top level meets the criteria of sufficiently daylit ($\geq 60\%$ of the floor area). Therefore, GM points are calculated as below.

$$\frac{\text{Number of Units Meeting Daylight Requirement}}{\text{Total Number of Units}} \cdot 2 \text{ Points} = \frac{2}{3} \text{ Points}$$

This result may be compared to the example section on “detailed daylight simulation,” where the top floor is daylit. The exact percentages from the daylight autonomy tables are different from the simulated values due to differences in room proportions and window placement. In addition, the tables are sometimes more pessimistic than simulated data as the closest WWR value that is less than the real value (worst case) is selected from the table. In such cases performing detailed lighting calculations would help to assess the true daylight potential of the housing complex which has slightly higher WWR glazing percentages compared to the values in the daylight autonomy tables.

Daylight Autonomy Table (200 lux)—0-11.25 degree Urban Obstruction

Unobstructed Urban Context (0–11.25 degree Urban Obstruction)

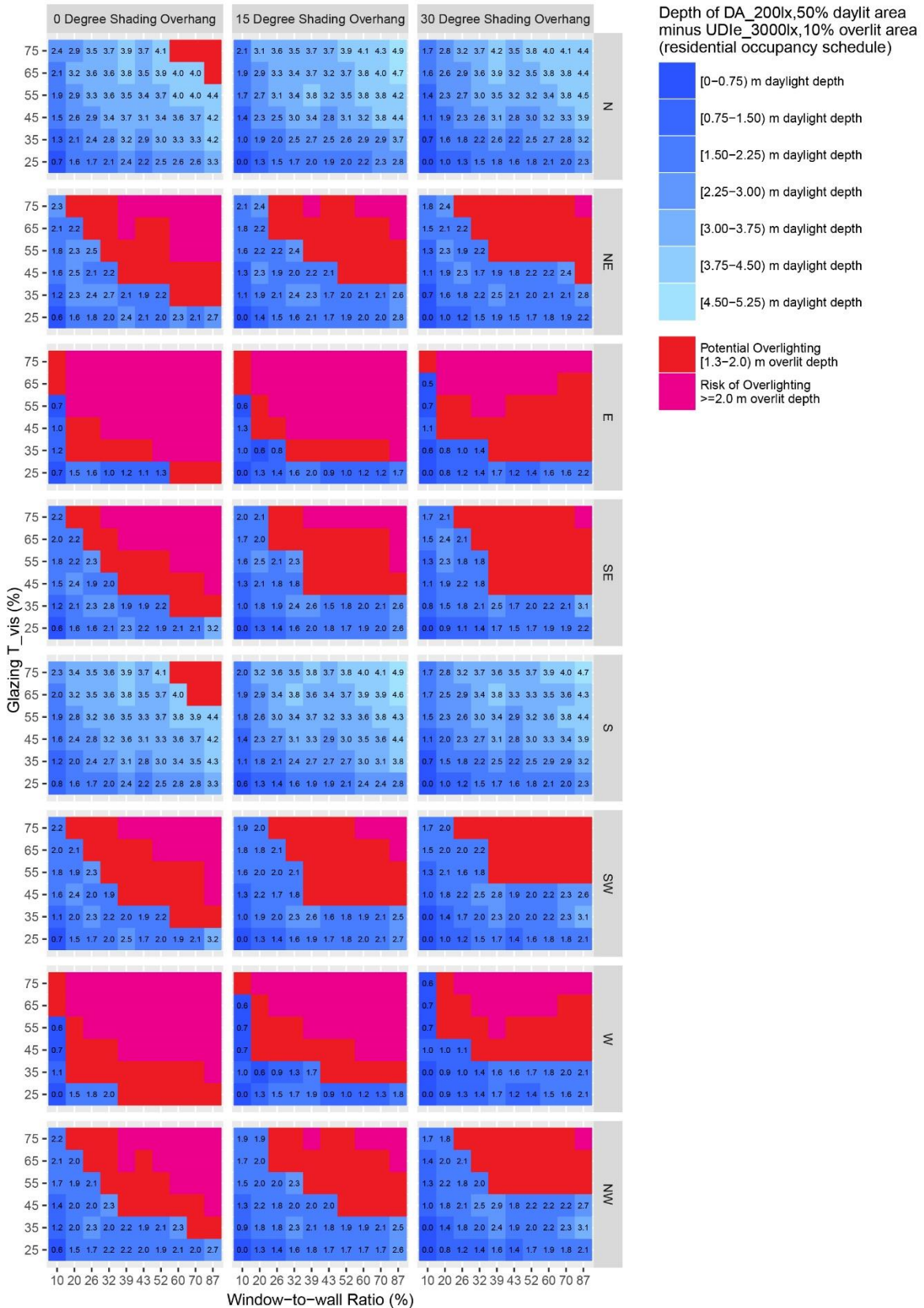

Daylight Autonomy Table (200 lux)—11.25–33.75 degree Urban Obstruction

22.5 degree Urban Context (11.25–33.75 degree Urban Obstruction)

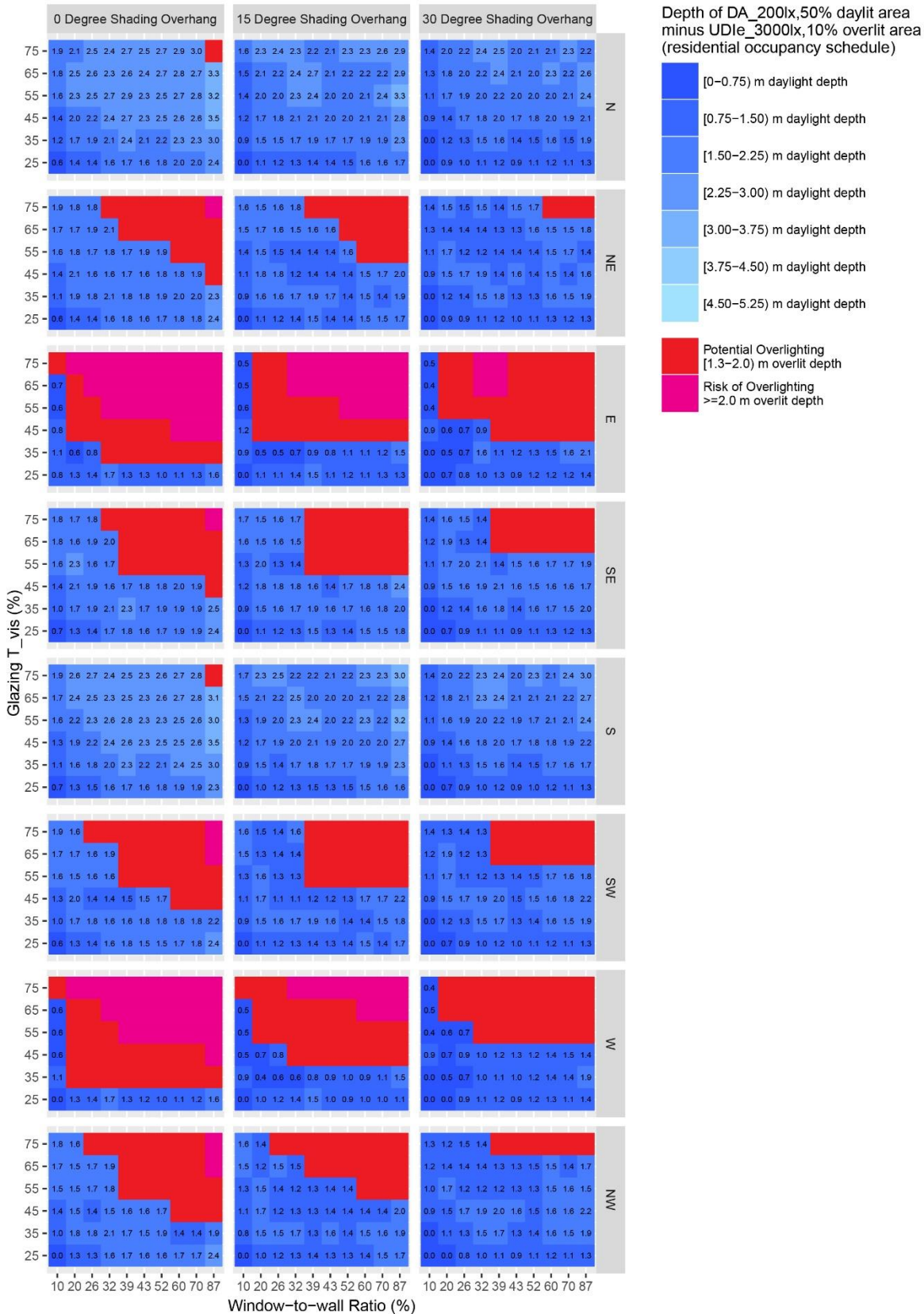

Daylight Autonomy Table (200 lux)—33.75–57.25 degree Urban Obstruction

45 degree Urban Context (33.75–57.25 degree Urban Obstruction)

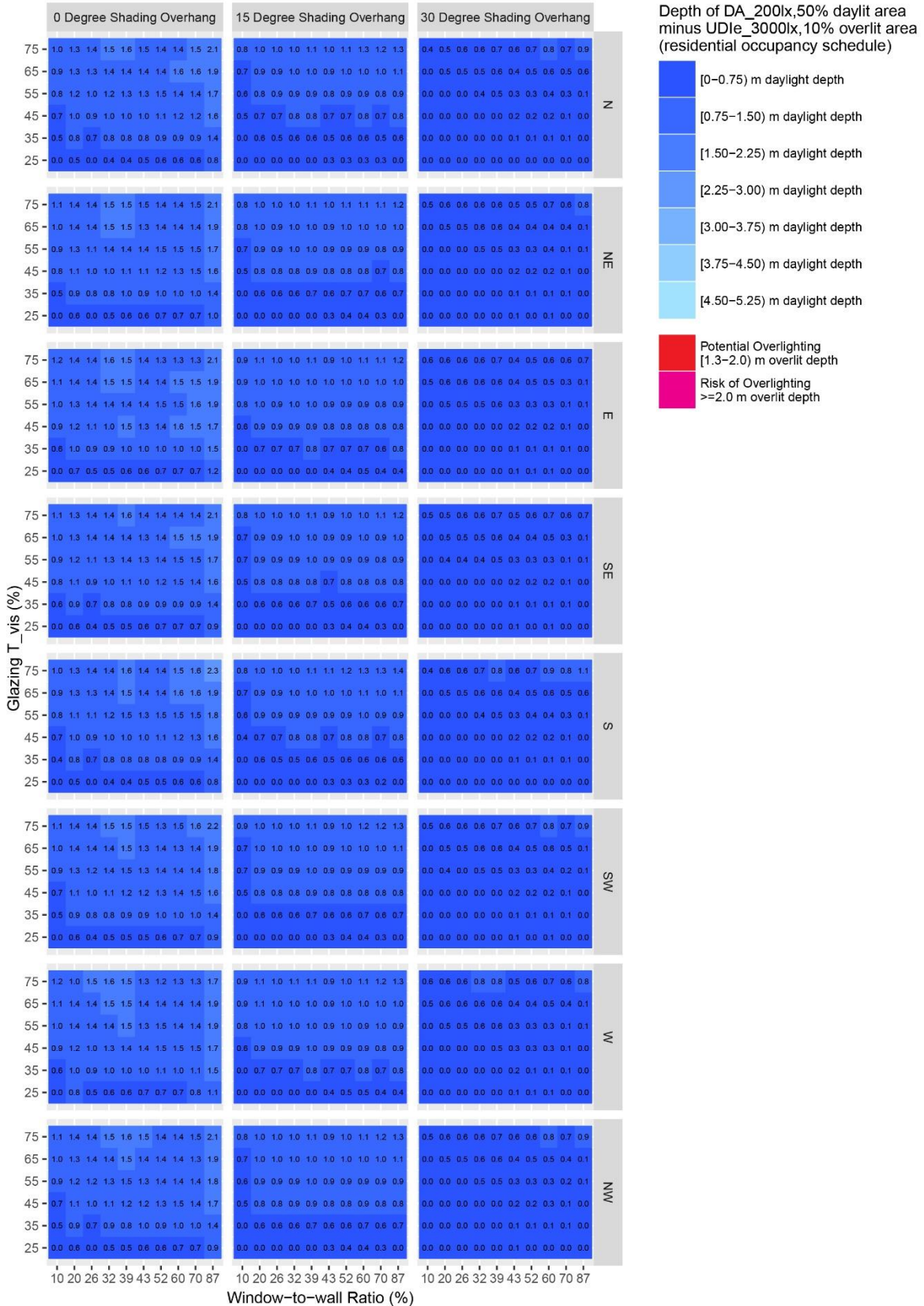

B3. Detailed Daylighting Simulation Guidelines

The below are guidelines and requirements for appropriately using daylighting simulations for Green Mark analysis.

Building 3D Modelling Requirements

3D models of buildings used for simulation should be constructed as close to 'as-built' as possible including the physical form, placement of windows, mullion details, thickness of opaque building components, exterior and surrounding obstructions and material properties. However, these components are not always well-known, so this subsection gives reasonable guidelines for setting up a simulation model.

General Guidelines

The building or space should be modelled with appropriate geometric complexity. Interior partitions and exterior walls should be modelled accurately and with their intended thicknesses. The floor-to-ceiling height should be accurate and account for architectural finish details such as dropped ceilings. The model should be constructed in such a way that appropriate material reflectance properties can be easily applied. For example, walls should be created in a manner that they can have a different material reflective property assigned than the floor and ceiling.

Small Details

Small details that will have little impact on the lighting distribution which are often contained in BIM models need not be included in the daylighting model: door handles, HVAC diffuser grills, wall electrical panels, etc. A general guideline is that if something is parallel to and near a larger surface, it should be modelled separately only if it is larger than 3 m and varies in material reflectance more than 20% from the surrounding surfaces. In all cases, increased amounts of detail are permitted—but not required—in the daylighting model.

Window and Skylight Details

Window and skylight openings should be modelled in three-dimensions, accounting for the thickness of the wall or ceiling in which they are set. For example, a skylight has a vertical offset between its glazing surface and the ceiling, known as the skylight well. Such details should be articulated in the simulation model. Window and skylight details greater than 5cm in any direction—such as sills, jambs, sashes and mullions—should be modelled as such. When the details of window framing are not known, a 20% reduction to the visible transmittance of the glass should be applied. For skylights, the reduction factor when framing details are not known should be 10%.

Exterior Obstructions and Shading Devices

Exterior obstructions that will cast shadows and reflect light should always be modelled using the following guidelines at a minimum. Exterior obstructions within a distance of 40 m from the façade of the building being studied should be modelled. This includes local devices that will cast shade such as louvers, overhangs, fins and balconies. Exterior buildings adjacent to the site should be modelled with no more than 4 m of geometric error. Trees should be modelled as appropriately dimensioned cones or spheres with material properties as defined in the 'Material Reflectance and Transmittance Properties' section below. In all cases of exterior and local obstructions, more detailed modelling is allowable.

Furniture and Partitions

When a furniture design is known, furniture surfaces and half-height partitions (cubicle walls, for example) that are higher than 90 cm above the finished floor height should be modelled within 15 cm of geometric accuracy.

Material Reflectance and Transmittance Properties

All reflectance and transmittance properties of materials should be defined based on measurements, construction finish specifications or glazing specifications when known. The value of the glazing visible light transmittance (T_{vis}) shall be extracted from the glazing specifications used for the project, such as in RETV calculations. Otherwise, a T_{vis} value of 0.45 (transmissivity of 0.491) may be used for glass materials. For reflectance values, the following default values may be used

Object Type	Reflectance Value
Wall or partition	0.70
Floor – carpet	0.20
Floor – tile	0.40
Floor – plaster	0.70
Furniture	0.50
Ceiling	0.80
Exterior – roof	0.10
Exterior – asphalt pavement	0.10
Exterior – grass	0.20
Exterior – tree	0.20
Exterior – paving blocks	0.30
Exterior – building facades	0.35
Exterior – stainless steel	0.85
Exterior – swimming pool water	0.90

Occupied Hours / Analysis Period

As DA_{Nlx} and $UDI_{e3000lx}$ are defined as a percentage of occurrence over an occupied period of a building, this period must be explicitly defined for lighting analysis. The period of analysis for residential buildings or buildings with residential-like schedules (such as hostels, service apartments, dormitories etc.) should use an occupancy schedule accounting for the first and last 3 hours of light per day, from 7:00 AM to 10:00 AM and from 4:00 PM to 7:00 PM.

Buildings with an unusual occupancy schedule may seek approval from BCA to pursue a custom occupancy period when deriving daylighting results.

Analysis Points and Sensor Grids

Sensor points for analysis should be placed in every space being analysed using a uniform grid where the spacing between adjacent sensors is no further apart than 60 cm. A 30 cm grid is recommended, and denser grids are permitted in the analysis. Analysis points that receive a maximum instantaneous lighting level of 1 lux throughout the year can be excluded from the analysis, presuming they are contained within an opaque object or non-daylit space such as a wall or closet.

Dynamic Shading Systems

Occupant-operated shading systems such as blinds or roller shades should not be modelled as the comparison between $DA_{N \text{ lx}}$ and $UDI_{e3000 \text{ lx}}$ is intended to balance daylight potential and the hours where window shades may be closed due to direct sunlight. However, there are cases where the modelling of active shading systems should be included in the calculations,

1. The case where a dynamic shading system is controlled by a completely automated system. In this case, the realistic geometry and material properties of the system as well as the control strategy should be accounted for in the simulation model.
2. The case where the Pre-Simulated Daylight Autonomy Tables indicate Potential Overlighting and Risk of Overlighting, a non-standard but manually operated system (see the section on Application of Daylighting Strategies for Spaces Exhibiting Potential for Visual Discomfort) is being used to reduce the risk of visual discomfort. In such cases, the Lightswitch behaviour model for avoiding direct sunlight should be utilized to control the shading system in the simulation model.
3. The case where an operable, light-redirecting system is critical to the daylighting performance of a space.

In all three of the above cases, accurate geometric and material properties of the shading systems should be accounted for. This can be done in the simulation engine of choice using a geometric model as in the Daysim calculation engine or using a bidirectional scattering and distribution function (BSDF) as in the Radiance three-phase method.

Daylighting Simulation Tools and Parameters

List of Capable Daylight Simulation Tools

The list of tools in the table below have the capability to calculate the metrics required for Green Mark daylighting certification. This list is meant to be instructive and may not be exhaustive. Most of these tools are interfaces to the Radiance and/or Daysim lighting simulation engines.

Software Name	Plug-in for (if applicable)	Website URI
DIVA-for-Rhino	Rhinoceros 3D	http://www.diva4rhino.com
Ecotect (as an interface for Daysim)	-	<Discontinued>
	<i>Comment: $UDI_{e3000 \text{ lx}}$ must be simulated separately as $DA_{3000 \text{ lx}}$.</i>	
Groundhog	Sketchup	http://igd-labs.github.io/Groundhog
IES-VE	-	http://www.iesve.com
Ladybug	Rhinoceros 3D	http://www.grasshopper3d.com/group/ladybug
	<i>Comment: $UDI_{e3000 \text{ lx}}$ must be simulated separately as $DA_{3000 \text{ lx}}$.</i>	
Lightstanza	-	http://www.lightstanza.com
	<i>Comment: Availability of required output metrics should be verified.</i>	
OpenStudio	Sketchup	https://www.openstudio.net
	<i>Comment: Results are only available as tabulated results, not spatial visualizations.</i>	
Sefaira	Sketchup & Revit	http://sefaira.com/daylighting
	<i>Comment: Availability of required output metrics should be verified.</i>	
SPOT	Excel	https://www.daylightinginnovations.com/spot-home
VI-Suite	Blender	http://blogs.brighton.ac.uk/visuite

Simulation Details

If not using one of the simulation tools listed in the previous section, a tool should be chosen that can accurately account for geometry and material properties of buildings for an annual, 8760-hour, lighting calculation while producing the $DA_{200\text{ lx}}$ and $UDI_{e3000\text{ lx}}$ metrics.

Climate Data

All annual simulations used in deriving $DA_{200\text{ lx}}$ and $UDI_{e3000\text{ lx}}$ should be run using hourly climate data input from IWECC weather data or its equivalent from the closest geographic weather station (486980, Changi Airport or from a local weather station). Using this data will approximate the lighting and climatic norms of Singapore in the simulation results. The sky luminance distribution should be approximated at each hour using the Perez all-weather sky model, which is the default calculation mode in Radiance and Daysim-based annual climate-based analyses and for all of the tools listed in the section above.

Simulation Parameters

Simulation parameters should be chosen, no matter the tool that are capable of accurately representing the complexity of the interaction between light, geometry and material being considered. The simulation should account for enough bounces of light to represent the reflections of ambient light deep into the space. The following parameters are recommended in Radiance and Daysim-based analysis engines, and more stringent parameters are allowable in all cases.

Parameter Name	Command Line Shorthand	Value
Ambient bounces	-ab	6
Ambient divisions	-ad	1500
Ambient accuracy	-aa	0.1
Ambient supersamples	-as	500
Direct threshold	-dt	0

B4. Presentation of Simulation Results

Results should be presented as plan-based graphical plots of $DA_{200\text{ lx}}$ and $UDI_{e3000\text{ lx}}$ as well as tabulated percentage floor area values $DA_{200\text{ lx}, 50\%}$ and $UDI_{e3000\text{ lx}, 10\%}$ for each area analysed. It is permissible to analyse typical rooms for each orientation and urban context of the building and extrapolate those results to the entire built floor area using individual room data.

The total daylit area should be calculated as $UDI_{e3000\text{ lx}, 10\%}$ subtracted from $DA_{200\text{ lx}, 50\%}$ such that overlit areas are not counted as daylit. Buildings or spaces with an $UDI_{e3000\text{ lx}, 10\%}$ value greater than 15% of the floor area cannot be considered well-daylit.

References

P.2 Residential Envelope and Roof Thermal Transfer

[1] BCA Singapore 'Code on Envelope Thermal Performance for Buildings';

<http://www.bca.gov.sg/PerformanceBased/others/RETV.pdf>

P.3 Ventilation Performance

[2] BCA Singapore; 'BCA Green Mark Computational Fluid Dynamic Simulation Guidelines'

P.4 Air Tightness and Leakage

[3] Singapore Standard 212 – 'Specification for Aluminium Alloy Windows'; SPRING Singapore

[4] Singapore Standard 381 – Materials and Performance Tests for Aluminium Curtain Walls

1.1a Climatic & Contextually Responsive Brief

[5] The Singapore Institute of Architects 'Attributes of a Sustainable Built Environment'; SIA Publishing

[6] Sinclair, D. 'Guide to Using the RIBA Plan of Work 2013'; RIBA Publishing

1.1b Integrative Design Process

[7] ASHRAE Standard 189.1 'Standard for the Design of High-Performance Green Buildings – Informative Appendix H – Integrated Design'; American Society of Heating, Refrigerating and Air-Conditioning Refrigerating and Air-Conditioning Engineers

[8] Sinclair, D. 'Assembling a Collaborative Project Team, Practical Tools including Multidisciplinary Schedules of Services'; RIBA Publishing

[9] Integrative Process (IP) - ANSI Consensus National Standard Guide 'Design and Construction of Sustainable Buildings and Communities'; American National Standards Institute

1.1c Environmental Credentials of Project Team

[10] BCA Singapore 'Certified GMFM /GMFP / GMM / GMP; Retrieved: http://www.bca.gov.sg/GreenMark/gm_manager.html

[11] BCA Singapore 'Green and Gracious Builder Award'; Retrieved: http://www.bca.gov.sg/Awards/GGBA/builders_award.html

[12] ISO 14001 'Environmental management'; International Organisation for Standardisation

[13] Singapore Green Building Council 'Green Services Certification Scheme'; Retrieved:

<http://www.sgbc.sg/green-certifications/services-certification/>

1.1d Building Information Modelling (BIM)

[14] BCA Singapore 'Singapore BIM Guide – Version 2'; Retrieved: <https://www.corenet.gov.sg/media/586132/Singapore-BIM->

[15] Sinclair, D. 'BIM Overlay to the RIBA Outline Plan of Work'; RIBA Publishing

1.1e User Engagement

[16] BCA Singapore 'BCA Green Lease Toolkit: Office Green Schedule'; Retrieved:

http://www.bca.gov.sg/GreenMark/others/Office_Green_Schedule.docx

[17] BCA Singapore 'BCA Green Lease Toolkit: Retail Green Schedule'; Retrieved:

http://www.bca.gov.sg/GreenMark/others/Retail_Green_Schedule.docx

1.2a Sustainable Urbanism

[18] Environmental Protection Agency, Ireland (2002) 'Guidelines on the information to be contained in Environmental Impact Statements (EIS)'; Retrieved:

<http://www.epa.ie/pubs/advice/ea/guidelines/#.VRks5-H1Jww>

[19] European Commission (2015) 'Environmental Impact Guidance'; Retrieved:

<http://ec.europa.eu/environment/eia/eia-support.htm>

[20] U.S. Environmental Protection Agency 'National Environmental Policy Act (NEPA)'; Retrieved;

<http://www.epw.senate.gov/nepa69.pdf>

[21] ASTM E1980 -11 'Standard Practice for Calculating Solar Reflectance Index of Horizontal and Low Sloped Opaque Surfaces'; ASTM International

1.02b Integrated Landscape and Waterscape

[22] National Parks Board '1001 Garden Plants in Singapore 2nd edition'; NParks Publication

[23] National Parks Board 'Trees of our Garden City, 2nd edition'; NParks Publication

[24] National Parks Board, 'NParks Flora and Fauna Web'; Retrieved

<https://florafanaweb.nparks.gov.sg/>

[25] National Parks Board 'Landscape Excellence Assessment Framework (LEAF)'; Retrieved:

<https://www.nparks.gov.sg/partner-us/landscape->

[26] Public Utilities Board 'Active Beautiful Clean Waters Design Guidelines, 3rd Edition'; Retrieved:

http://www.pub.gov.sg/abcwaters/abcwatersdesignguidelines/Documents/ABC_DG_2014.pdf

1.3a Tropical Façade Performance

[27] BCA Singapore 'Code on Envelope Thermal Performance for Buildings'; Retrieved:

<http://www.bca.gov.sg/PerformanceBased/others/RETV.pdf>

P.6 Air Conditioning System Efficiency

[28] NEA Singapore Energy Labelling Scheme

2.1b Lighting System Efficiency

[29] Singapore Standard 530 'Code of Practice for Energy Efficiency Standard for Building Services and Equipment'; SPRING Singapore

[30] Singapore Standard 531 'Code of Practice for lighting of work places - Indoor'; SPRING Singapore

2.1c Car Park Energy

[31] Singapore Standard 530 'Code of Practice for Energy Efficiency Standard for Building Services and Equipment'; SPRING Singapore

2.2a Energy Efficient Practices, Design and Features

[32] NEA Singapore Energy Labelling Scheme

P.8 Water Fittings for Common Facilities

[33] Singapore Standard CP 48 – Code of Practice For water services

P.11 Sustainable Products

[34] Singapore Green Building Product (SGBP) Certification Scheme <http://www.sgbc.sg/green-certifications/product-certification>

[35] Singapore Green Label Scheme (SGLS) <http://www.sgls.sec.org.sg/sgls-standard.php>

3.1a Water Efficiency Measures

[36] Singapore Standard CP 48 'Code of Practice for water services'; SPRING Singapore

[37] Public Utilities Board, Singapore on Water Efficiency Labelling Scheme'; <https://www.pub.gov.sg/wels>

3.2a Sustainable Construction

[38] BCA Singapore Demolition Protocol 'Pre-Demolition Audit, Sequential Demolition and Site Waste Management Plan'; Retrieved https://www.bca.gov.sg/SustainableConstruction/sc_demolition.html

[39] Singapore Standard 557 'Code of Practice for demolition'; SPRING Singapore

[40] Singapore Standard EN 12620 'Specification for aggregates for concrete'; SPRING Singapore

[41] Singapore Standard EN 197-1 Cement - Part 1 'Composition, specifications and conformity criteria for common cements'; SPRING Singapore

[42] Singapore Standard EN 206-1 Concrete - Part 1 'Concrete: Specification, performance, production and conformity'; SPRING Singapore

[43] Singapore Standard 544-1 Concrete 'Complementary to SS EN 206-1 - Part 1- Method of specifying and guidance for the specifier'; SPRING Singapore

[44] Singapore Standard 544-2 Concrete 'Complementary Singapore Standard to SS EN 206-1 – Part 2: Specification for constituent materials and concrete'; SPRING Singapore

[45] Singapore Standard 557 'Code of Practice for Demolition'; SPRING Singapore

3.2b Embodied Carbon

[46] 'BCA Carbon Calculator';

<https://www.bca.gov.sg/CarbonCalculator>

3.2c Sustainable Products

[47] Singapore Green Building Product (SGBP) Certification Scheme <http://www.sqbc.sg/green-certifications/product-certification/>

[48] Singapore Green Label Scheme (SGLS) <http://www.sqsls.sec.org.sg/sqsls-standard.php>

4.2a Occupant Comfort

[49] ANSI/ASHRAE Standard 62.2 Ventilation and Acceptable Indoor Air Quality in Low-Rise Residential Buildings

4.2c Wellbeing

[50] *The Practice of Biophilic Design* by Stephen R. Kellert, Elizabeth F. Calabrese

[51] BCA Singapore, *Code on Accessibility in the Built environment*

5.1m Façade Design Strategies

[52] GBIC R&D Project - "Energy Efficient Building Facades for Thermal Comfort Environment" by Wong Nyuk Hien

Annex B

[53] Reinhart, Christoph F. "Lightswitch-2002: a model for manual and automated control of electric lighting and blinds.

Acknowledgements

The launch of Green Mark for Residential Buildings: GM RB 2016 is a result of our extensive industry collaboration across the construction value chain. We would like to extend our sincerest gratitude to all internal and external stakeholders for their invaluable support and contribution towards the development of Green Mark RB: 2016 that will enable us to develop a sustainable environment for our current and future generations.

BCA Working Group (Building and Construction Authority)

Management

Mr Ang Kiang Seng
Mr Tan Tian Chong
Mr Jeffery Neng Kwei Sung
Ms Leong-Kok Su Ming
Mr Toh Eng Shyan
Ms May Siu Yee
Dr Edward Ang

Secretariat

Ms Lee Sui Fung
Ms Neo Hwei Fern
Ms Ong Hui Wen
Ms Michelle Tan Minxuan
Mr Derek Ang Wei Xiang

Workgroup Leads/Co-Lead

Ms Alice Goh
Ms Chan Vun Ching
Ms Chris Tay
Ms Denise Kwok
Mr Derek Ang Wei Xiang
Ms Grace Cheok-Chan
Ms Jacqueline Teresa Britto
Mr Jordan Liang
Mr Lim San Teng
Ms Lee Sui Fung
Mr Leow Yock Keng
Mr Li Kunlin
Ms Li Ruixin
Mr Low Giau Leong
Mr Max Xu Mingfeng
Ms Ong Hui Wen

Green Mark Advisory Committee (Apr 2016 – Jun 2019)

Er Lee Chuan Seng, Chair (Beca Asia Holdings Pte Ltd)
Mr Tang Kok Thye, Deputy Chair (ADDP Architects LLP)
Er Lam Siew Wah, Deputy Chair
(Building and Construction Authority)
Mr Neo Choon Keong, Deputy Chair
(Building and Construction Authority)
Mr Ang Kian Seng (Building and Construction Authority)
Dr Er Johnny Wong (Housing and Development Board)
Mr Ang Kok Kiat (National Environment Agency)
Mr Anthony Goh (City Developments Limited)
Dr Ho Nyok Yong (Samwoh Corporation Pte Ltd)
Mr Joseph Loh (G-Energy Global Pte Ltd)
Mr Koh Chwee (Jurong Town Corporation)

Er Koh Kin Teng (Squire Mech Pte Ltd)
Prof Lam Khee Poh (Nanyang Technological University)
Mr Lim Fatt Seng (Comfort Management Pte Ltd)
Er Lim Ming Sing, Alfred (CapitaLand Singapore Ltd)
Mr Lim Tow Fok (Keppel Land Limited)
Prof Raymond Wong (Nanyang Technological University)
Ms Susannah West (JLL)
Mr Tan Phay Ping (Building System and Diagnostics Pte Ltd)
Mr Tan Sze Hann (Surbana Jurong Pte Ltd)
Mr Tan Tian Chong (Building and Construction Authority)
Mr Teo Orh Hai (Building and Construction Authority)
Er Tony Tay (Parsons Brinckerhoff Pte Ltd)

Envelope & Façade Taskforce

Prof Chou Siaw Kiang, Co-Chair (National University of Singapore)
Mr Alfred Ng (City Developments Ltd)
Ms Maggie Low (Technoform Bautec Asia Pacific Pte Ltd)
Mr Mathieu S. Meur (Meinhardt Façade Technology International)
Mr Alvin Oh S C (Housing & Development Board)
Prof Wong Nyuk Hien (National University of Singapore)

NV Taskforce

Prof Wong Nyuk Hien, Co-Chair (National University of Singapore)
Mr Alfred Ng (City Developments Ltd)
Dr George Xu (Parsons Brinckerhoff Pte Ltd)
Mr Markus Cheng (ADDP Architects LLP)
Mr Alvin Oh S C (Housing & Development Board)
Mr Shyan Ong Joe Cher (Mott MacDonald Singapore Pte Ltd)
Dr Poh Hee Joo
(Institute of High Performance Computing, A*STAR)
Mr Po Woei Ken (Building System and Diagnostics Pte Ltd)
Dr Jonathan Tai Chin Hoe (C2D Solutions Pte Ltd)
Mr Tan Phay Ping (Building System and Diagnostics Pte Ltd)
Mr Amir Wee Kim Hor (CFD Research (Singapore) Pte Ltd)

Outdoor Air Taskforce

Prof Tham Kwok Wai, Co-Chair (National University of Singapore)
Mr Ng Boon Hock (CapitaLand Singapore Ltd)
Mr Wong Ee Ven (Keppel Land International Ltd)
Prof Balasubramaniam (National University of Singapore)
Prof David Cheong Kok Wai (National University of Singapore)
Prof Raymond Wong (Nanyang Technological University)
Mr Tham Shee Leng (National Environment Agency)
Mr Ron Tan (National Environment Agency)
Mr Tan Sze Tiong (Housing & Development Board)
Mr Alvin Oh S C (Housing & Development Board)
Mr Huang Dingyong (Housing & Development Board)
Er Tan Peck Khoon (Rankine & Hill (Singapore) Pte Ltd)

Ms Vivian Feng (Rankine & Hill (Singapore) Pte Ltd)
 Mr Jimmy Ang (Rankine & Hill (Singapore) Pte Ltd)
 Ms Wong Lai Ching (Beca Carter Hollings & Ferner (S.E.Asia))
 Mr Yanto Halim (Daikin Airconditioning (Singapore) Pte Ltd)
 Mr Swen Tan (Daikin Airconditioning (Singapore) Pte Ltd)
 Mr Ke Yam Cheong (Mitsubishi Electric Asia Pte Ltd)
 Mr Fenny Lim (Mitsubishi Electric Asia Pte Ltd)

Architectural Taskforce

Mr Cheong Yew Kee, Chair (2B Architects)
 Ms Jaye Tan, Co-Chair (Studio Green Pte Ltd)
 Mr Siow Zhi Xiang, Co-Chair (CPG Consultants Pte Ltd)
 Ms Astee Lim (Jurong Consultants Pte Ltd)
 Ms Chang Yen Lin (KPK Quantity Surveyors (Singapore) Pte Ltd)
 Mr Kuan Chee Yung (CPG Consultants Pte Ltd)
 Mr Sonny Chionh (RSP Architects Planners & Engineers Pte Ltd)
 Mr Tan Sze Hann (Surbana Jurong Pte Ltd)
 Dr To Kien (Singapore University of Technology and Design)

Green Products & Materials-Taskforce

Er Yvonne Soh, Co-Chair (Singapore Green Building Council)
 Mr Edwin Fong (SPRING Singapore)
 Mr Eugene Yong (The Singapore Contractors Association Ltd)
 Mr Goh Su-Liang (Singapore Green Building Council)
 Ms Jennifer Yap (National Environmental Agency)
 Ms Joanna Shen (National Environmental Agency)
 Mr Kavickumar s/o Muruganathan
 (Singapore Environment Council)
 Mr Kuan Chee Yung (CPG Consultants Pte Ltd)
 Mr Lim Tow Fok
 (Real Estate Developers' Association of Singapore)
 Mr Ng Wee Kok (Singapore Manufacturer Federation)
 Mr Pang Tong Teck (Singapore Civil Defence Force)
 Dr Song Bin (Singapore Institute of Manufacturing Technology)

Lighting Taskforce

Er Yvonne Soh, Co-Chair (Singapore Green Building Council)
 Mr Eddy Lau, Co-Chair (Singapore Green Building Council)
 Mr Adrian Ting (CapitaLand Limited)
 Dr Chien Szu-Cheng
 (Berkeley Education Alliance for Research in Singapore)
 Mr Dan Foreman (ARUP Singapore Pte Ltd)
 Mr Gaurav Jain (Lighting Planners Associates (S) Pte Ltd)
 Ms Irene Yong (Beca Carter Hollings & Ferner (S.E.Asia) Pte Ltd)
 Mr Kevin Sturrock (iLab Pte Ltd)
 Ms Ong Swee Hong (ONG&ONG Pte Ltd)
 Mr Rodney Lim (Singapore Green Building Council)
 Ms Toh Yan Li (Light Collab LLP)

Noise & Acoustics Taskforce

Prof Lee Siew Eang, Co-Chair (National University of Singapore)
 Mr Alvin Cheong (Alfern Engineering Consultancy Pte Ltd)
 Ms Emily Tan Hui Ching (Earth-In-Mind Pte Ltd)
 Mr Gabriel Anthony Vincent (CPG Consultants Pte Ltd)
 Dr Kenny Yap (Acoustics & Environmental Solutions Pte Ltd)
 Er Koh Kin Teng (Squire Mech Pte Ltd)
 Mr Lai Kok Heng (City Developments Ltd)

Er Tan Kiat Leong
 (Beca Carter Hollings & Ferner (S.E.Asia) Pte Ltd)
 Dr Xu Jingfeng (ARUP Singapore Pte Ltd)

Solar PV Taskforce

Er Lee Chuan Seng, Co-Chair (Beca Asia Holdings Pte Ltd)
 Mr Allen Ang (Keppel Land Limited)
 Mr Desmond Chan (Singapore Economic Development Board)
 Mr Lester Chia Ming Hang (Housing & Development Board)
 Dr Er Johnny Wong (Housing & Development Board)
 Mr Johnny Lim Chin Huat (Surbana Jurong Pte Ltd)
 Ms Kavita Gandhi (Sustainable Energy Association of Singapore)
 Mr Kong Wei Jie (Energetix Pte Ltd)
 Dr Liu Licheng (Saferay Pte Ltd)
 Mr Mark Netto (Sustainable Energy Association of Singapore)
 Ms Olivia Oo (Singapore Economic Development Board)
 Dr Thomas Reindl
 (Solar Energy Research Institute of Singapore/ National
 University of Singapore)

Sustainable Construction and Carbon taskforce

Er Lim Peng Hong, Co-Chair
 (Association of Consulting Engineers Singapore)
 Er Chia Wah Kam (ARUP Singapore Pte Ltd)
 Dr Ho Nyok Yong (The Singapore Contractors Association Ltd)
 Er Joseph Goh (Institution of Engineers Singapore)
 Er Lauw Su Wee (LSW Consulting Engineers Singapore)
 Dr Song Bin (Singapore Institute of Manufacturing Technology)
 Dr Tan Guan (T.Y. Lin International Group)
 Er Quak Cheow Swee
 (Beca Carter Hollings & Ferner (S.E.Asia) Pte Ltd)
 Er Yvonne Soh (Singapore Green Building Council)

Academic Collaborations

Prof Bert Blocken (Eindhoven University of Technology)
 Asst Prof J. Alstan Jakubiec
 (Singapore University of Technology and Design)

Others

BCA would also like to thank the following organisations who have made invaluable contributions during the criteria conceptualisation and piloting phase:

ADDP Architects LLP
 ARUP Singapore Pte Ltd
 Building System and Diagnostics Pte Ltd
 Housing & Development Board
 Land Transport Authority
 LendLease Pte Ltd
 National Environment Agency
 National Parks Board
 PUB, Singapore's National Water Agency
 Singapore Green Building Council
 Singapore Institute of Architects
 Surbana Jurong Pte Ltd